



US00D345476S

# United States Patent [19]

[11] Patent Number: **Des. 345,476**

**Burdick et al.**

[45] Date of Patent: **\*\* Mar. 29, 1994**

## [54] TABLE BASE

[75] Inventors: **Bruce Burdick; Susan K. Burdick**, both of San Francisco, Calif.

[73] Assignee: **The Burdick Group**, San Francisco, Calif.

[\*\*] Term: **14 Years**

[21] Appl. No.: **841,753**

[22] Filed: **Feb. 28, 1992**

[52] U.S. Cl. .... **D6/495; D6/480**

[58] Field of Search ..... **D6/480, 482-489, D6/495, 496, 498, 499, 429-431; 108/152, 153, 161, 115**

## [56] References Cited

### U.S. PATENT DOCUMENTS

D. 179,900	3/1957	Jones et al. ....	D6/480
D. 228,106	8/1973	Klotz et al. ....	D6/484
D. 271,354	11/1983	Lerner ....	D6/480
D. 299,169	1/1989	Frinier ....	D6/495 X
3,349,728	10/1967	Barecki et al. ....	108/115 X
5,078,055	1/1992	Bellini et al. ....	108/153 X

### OTHER PUBLICATIONS

Scandiline.

*Domus*—May 1988, p. 14, Umberto Riva Table.

*Primary Examiner*—Nelson C. Holtje

*Assistant Examiner*—J. E. Seeger

*Attorney, Agent, or Firm*—Saidman DesignLaw Group

## [57] CLAIM

The ornamental design for a table base, as shown and described.

## DESCRIPTION

FIG. 1 is a top plan view of a table base showing a first preferred embodiment of our new design;

FIG. 2 is a front elevational view thereof, the rear elevational view being substantially the same;

FIG. 3 is a bottom plan view thereof;

FIG. 4 is a side view in elevation thereof, the left and right side views being substantially the same;

FIG. 5 is a top plan view of a table base showing a second preferred embodiment of our new design, the bottom plan view thereof being substantially the same as shown in FIG. 3;

FIG. 6 is a front view in elevation of the second embodiment shown in FIG. 5, the rear elevational view being substantially the same;

FIG. 7 is a side view in elevation of the second embodiment, the left and right side elevational views being substantially the same;

FIG. 8 is a bottom plan view of a table base showing a third embodiment of our design, the top, side, front and rear views being the same as shown in either the first embodiment of FIGS. 1, 2 and 4, or the second embodiment of FIGS. 5-7; and,

FIG. 9 is a perspective view of the second embodiment of FIGS. 3 and 5-7.

The broken lines showing a table top in FIGS. 1-9 are environmental only and form no part of the claimed design.

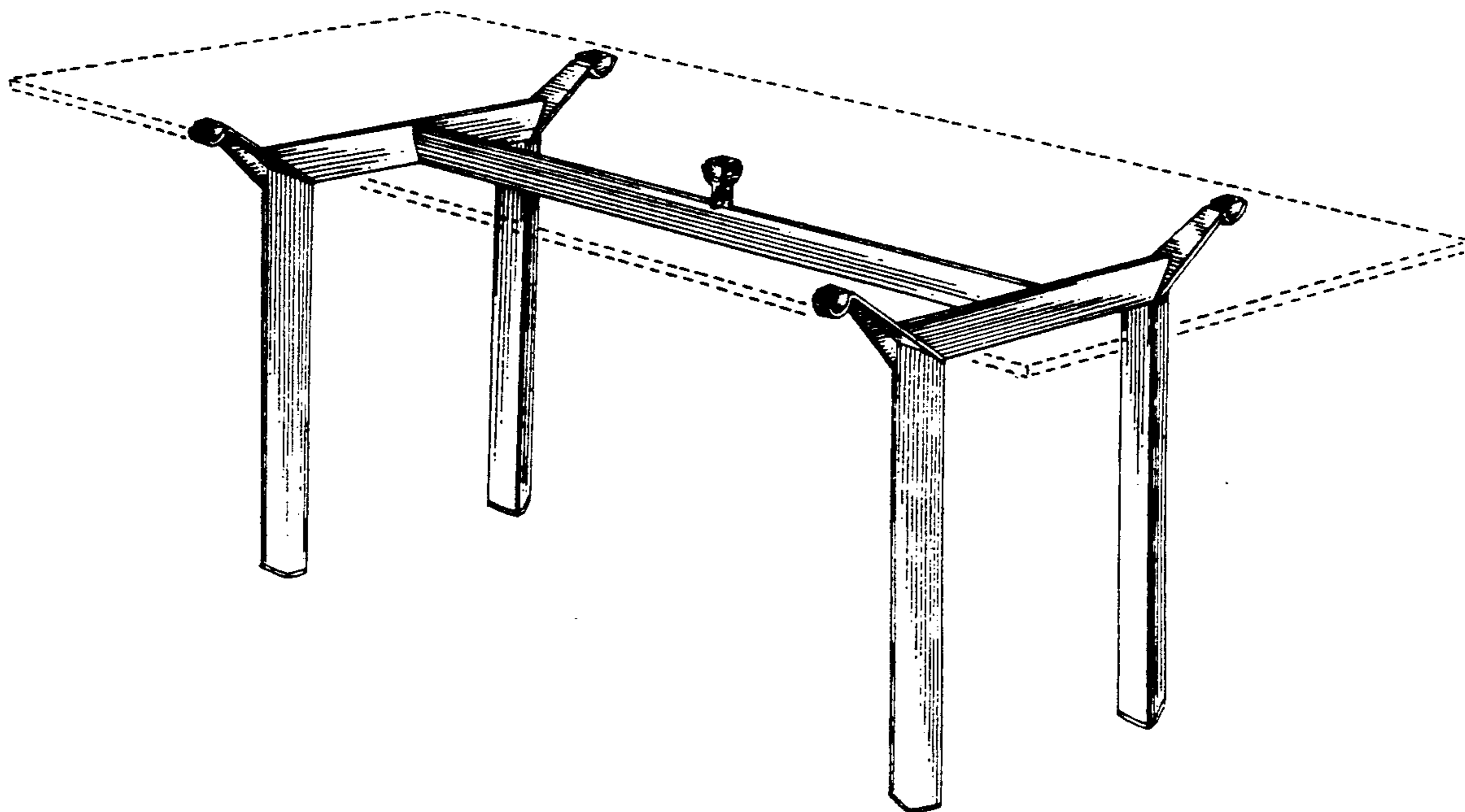

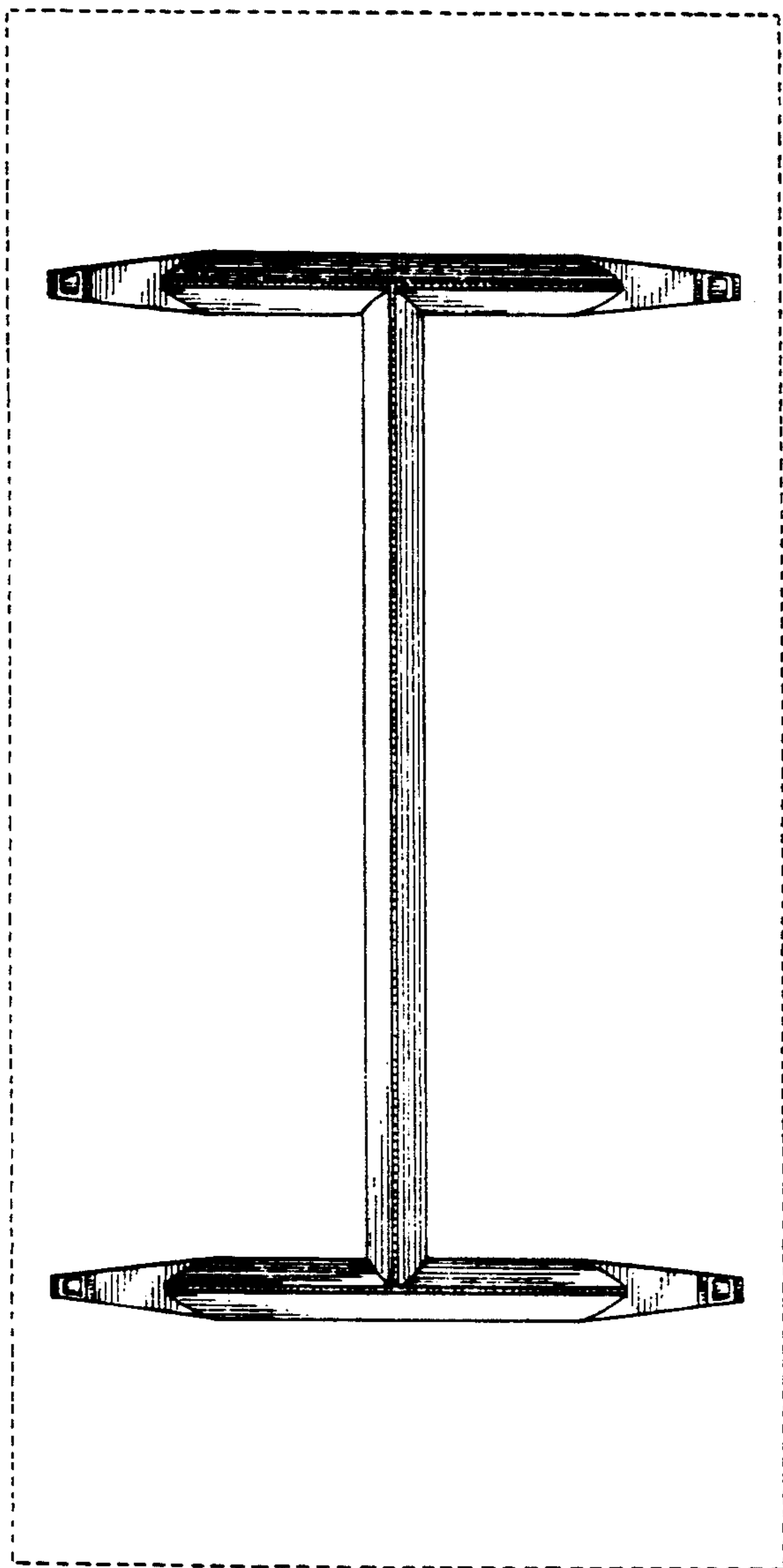

FIG. 1

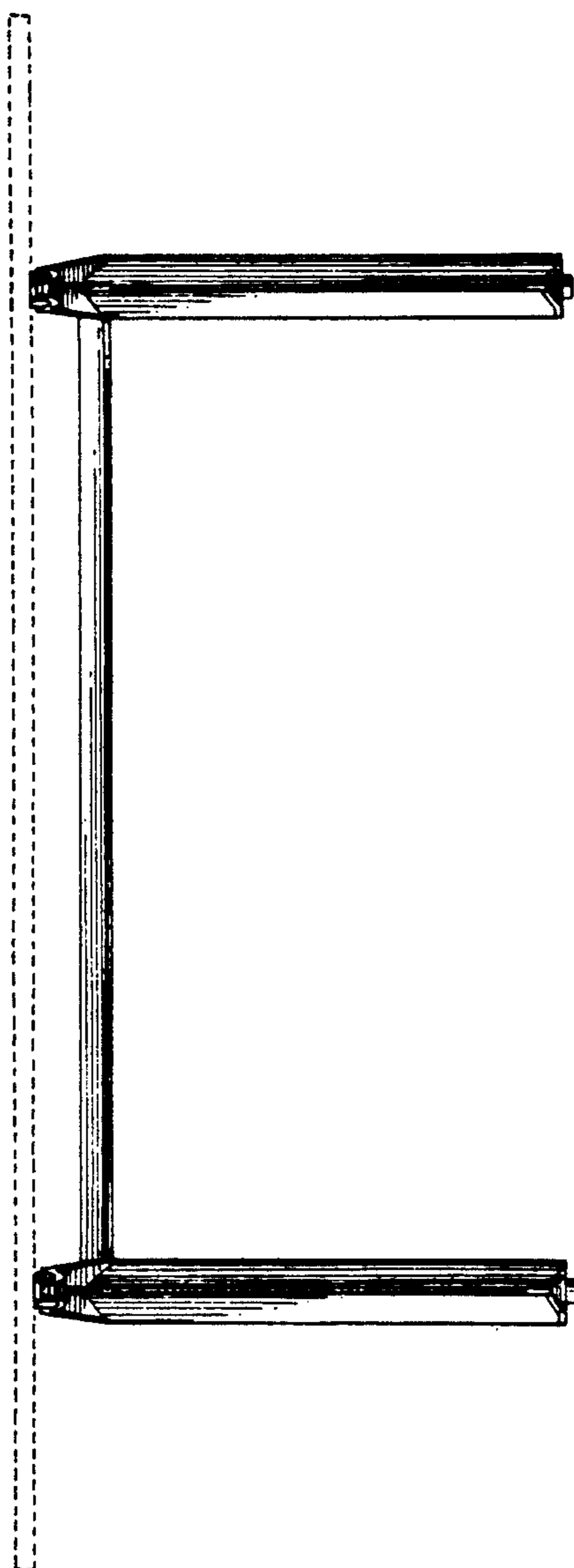

FIG. 2

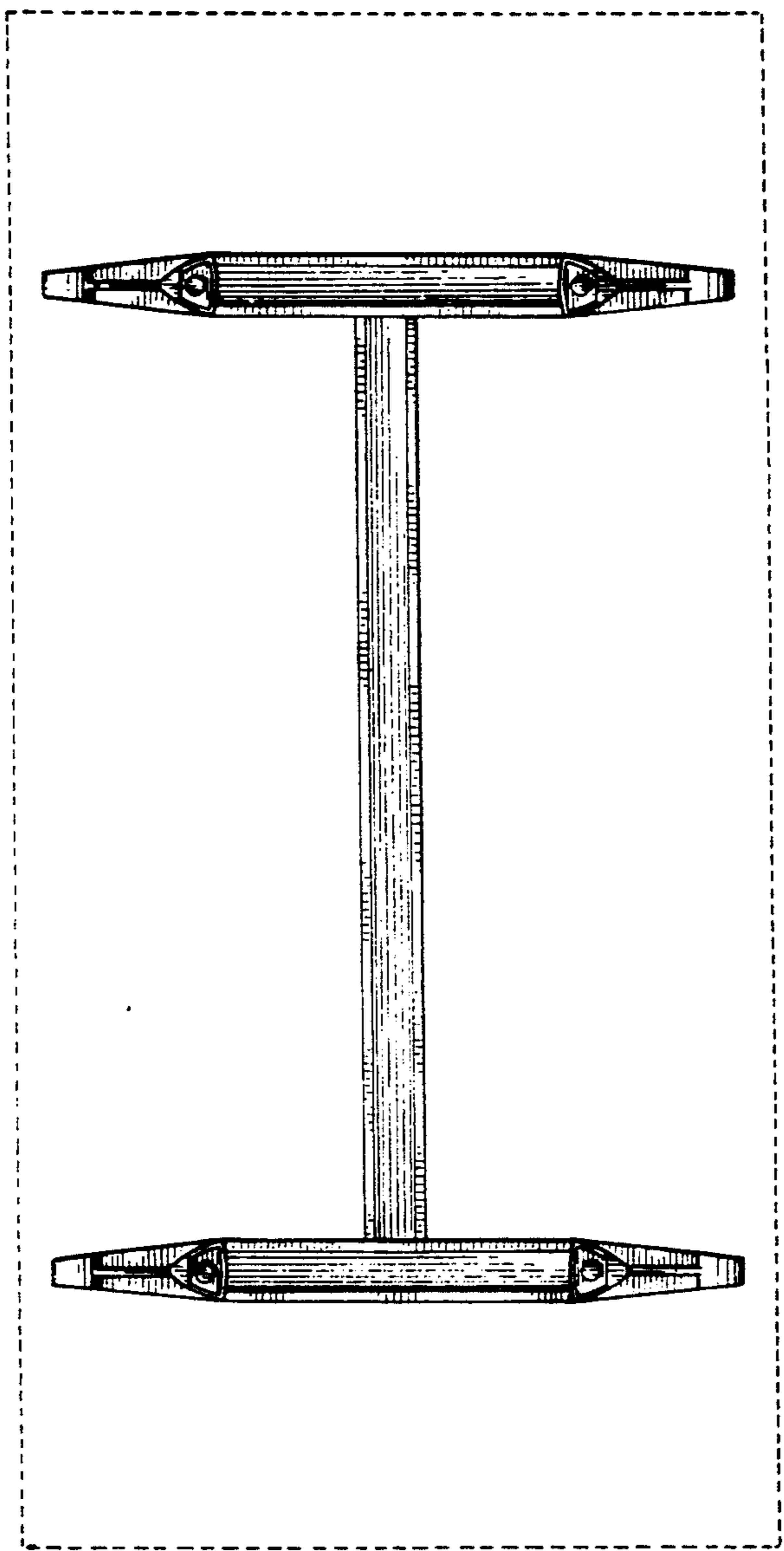

FIG. 3

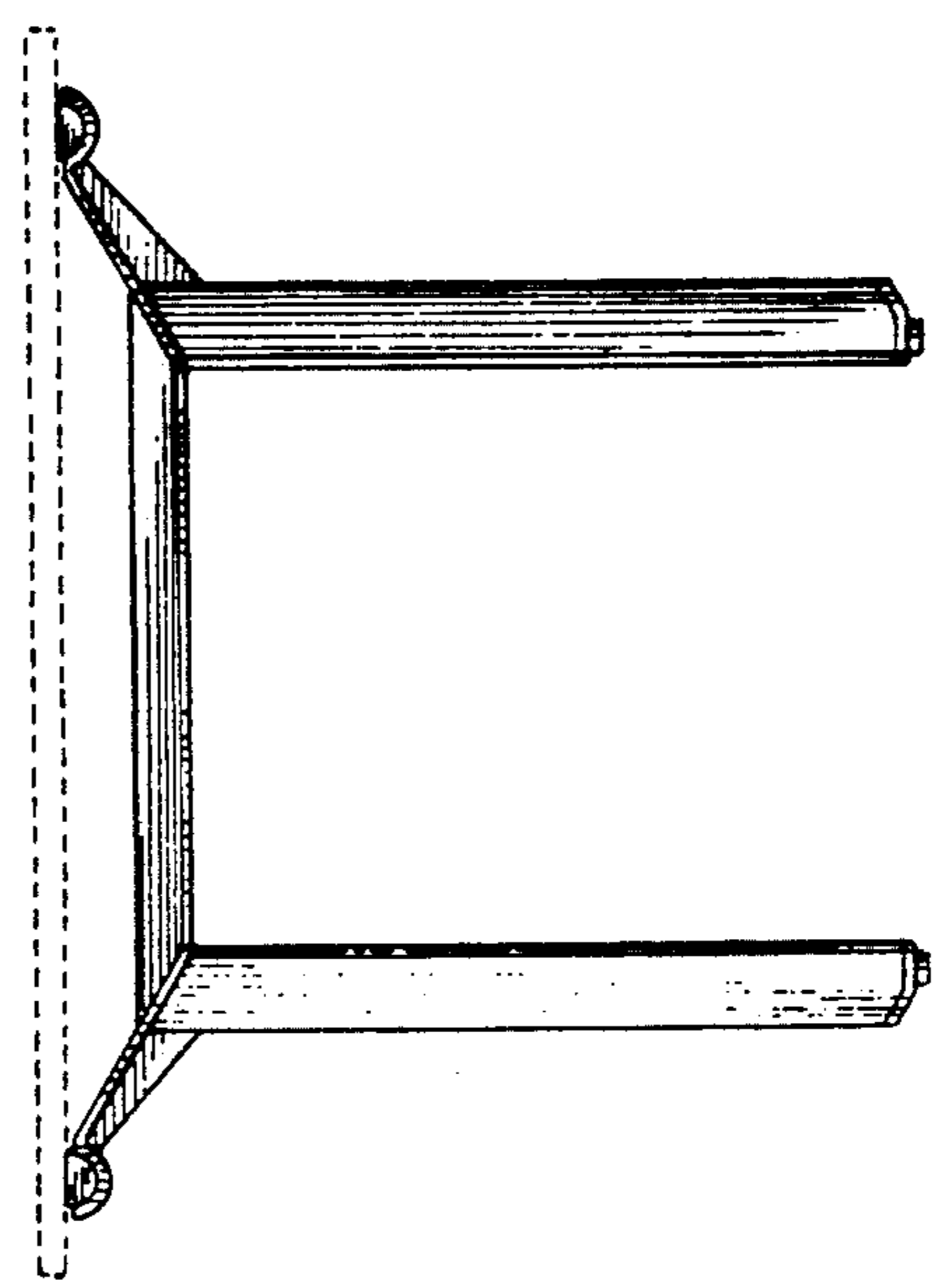

FIG. 4

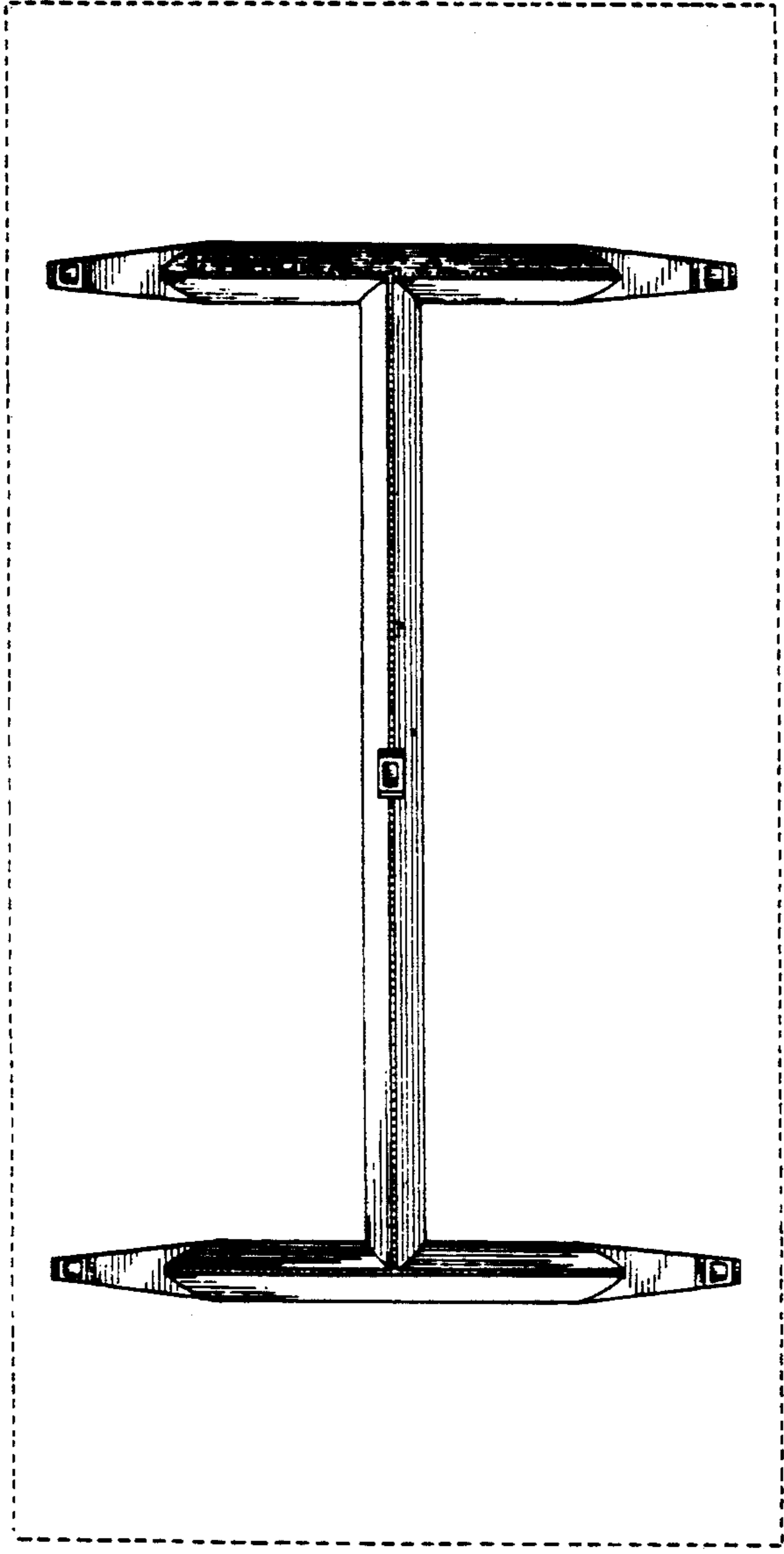

FIG. 5

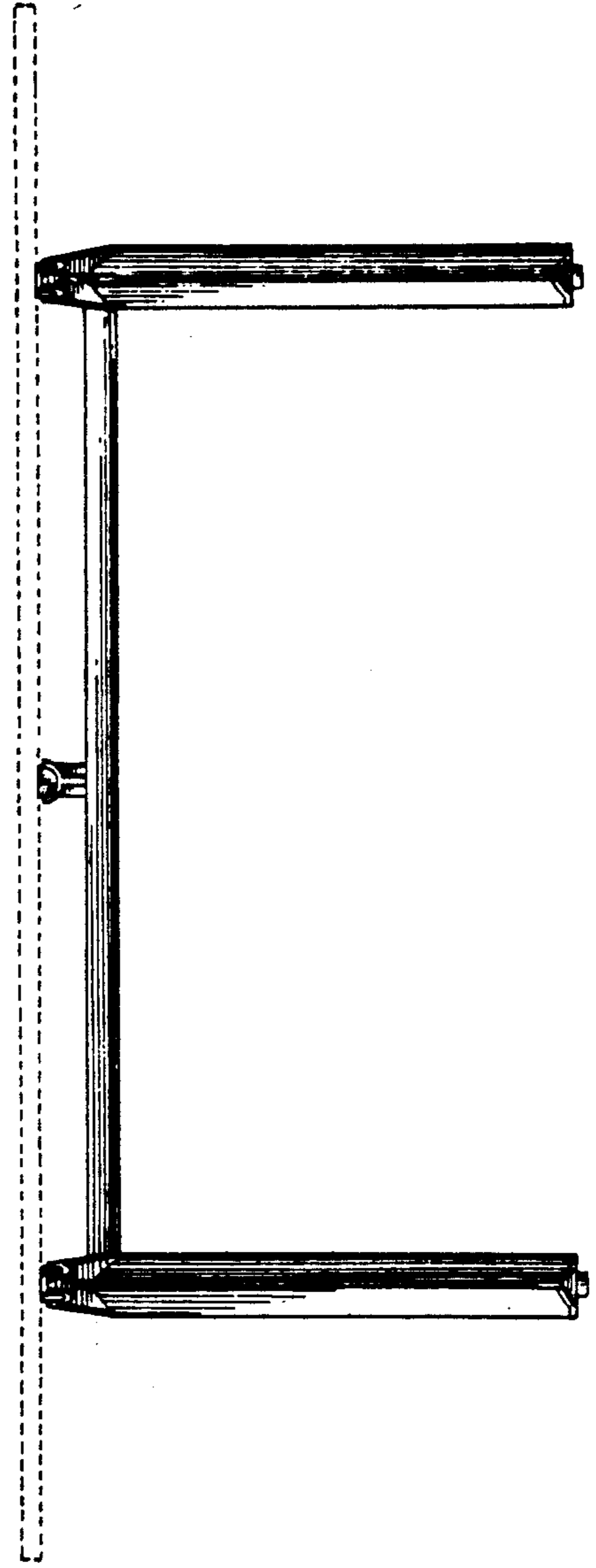

FIG. 6

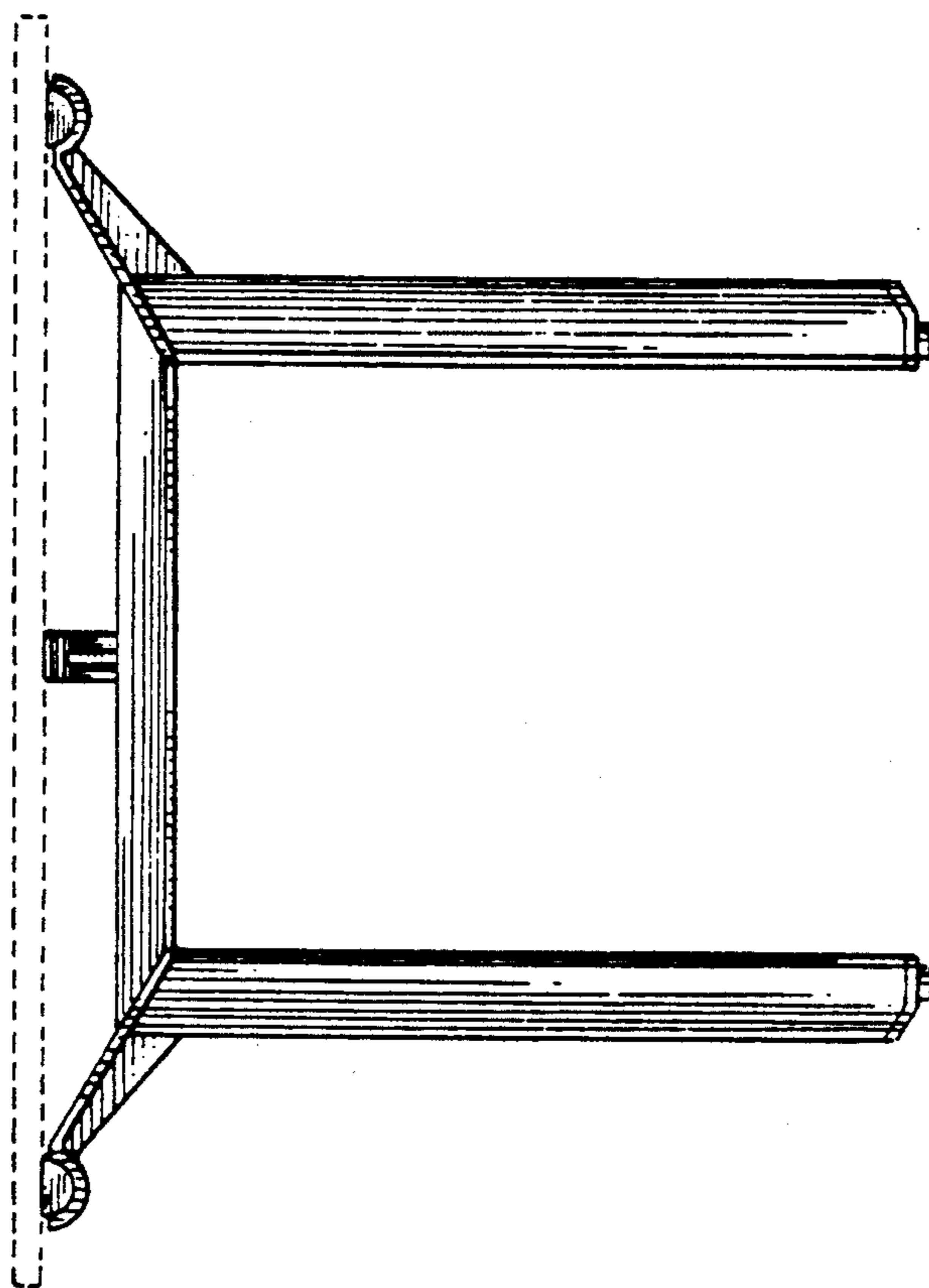

FIG. 7

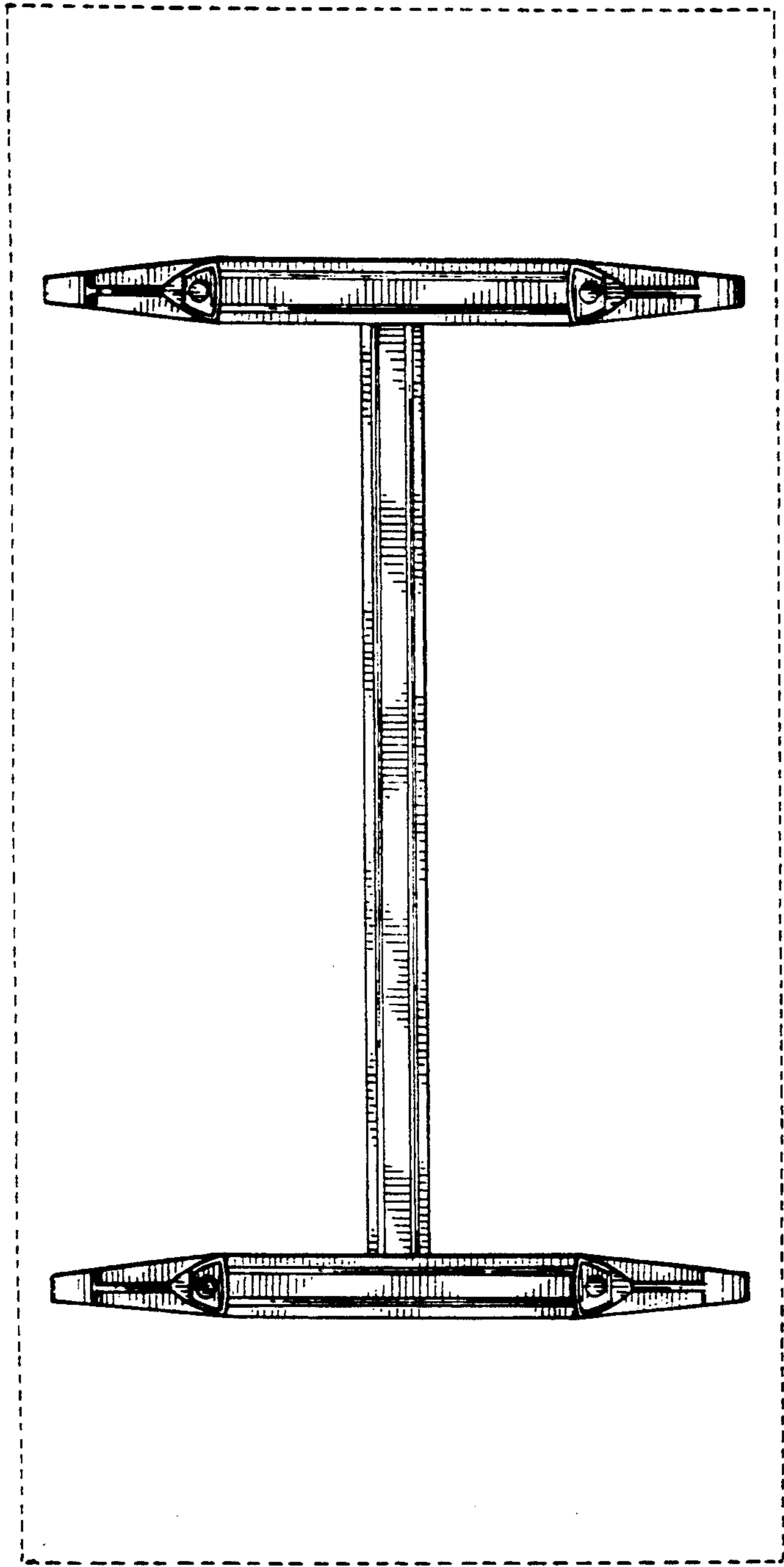

FIG. 8



FIG. 9

