



US00D345424S

# United States Patent [19]

[11] Patent Number: Des. 345,424

Gudeein

[45] Date of Patent: \*\* Mar. 22, 1994

- [54] COMBINED MASSAGER AND COVER
- [75] Inventor: Jacques Gudeein, Saint Priest, France
- [73] Assignee: Calor S.A., Lyons, France
- [\*\*] Term: 14 Years
- [21] Appl. No.: 912,711
- [22] Filed: Jul. 13, 1992

Primary Examiner—Stella Reid  
 Attorney, Agent, or Firm—Young & Thompson

[57] CLAIM

The ornamental design for a combined massager and cover, as shown and described.

DESCRIPTION

FIG. 1 is a front elevational view of an a combined massager and cover, showing my new design, with the cover attached;  
 FIG. 2 is a rear elevational view thereof;  
 FIG. 3 is a right side elevational view thereof;  
 FIG. 4 is a left side elevational view thereof;  
 FIG. 5 is a top plan view thereof;  
 FIG. 6 is a bottom plan view thereof;  
 FIG. 7 is a perspective view thereof;  
 FIG. 8 is a front elevational view thereof, with the cover removed;  
 FIG. 9 is a rear elevational view thereof;  
 FIG. 10 is a right side elevational view thereof;  
 FIG. 11 is a left side elevational view thereof;  
 FIG. 12 is a bottom plan view thereof; and,  
 FIG. 13 is a perspective view thereof.

- [30] Foreign Application Priority Data
- Jan. 17, 1992 [FR] France ..... 920 286
- [52] U.S. Cl. .... D24/215; D24/211
- [58] Field of Search ..... 128/44, 46, 59-62 R,  
128/36, 67; D24/200, 214, 215, 211-213

- [56] References Cited
- U.S. PATENT DOCUMENTS
- D. 299,863 2/1989 Noble et al. .... D24/211
- D. 300,853 4/1989 Smal ..... D24/211
- 2,988,084 6/1961 Douglas ..... D24/211 X
- 3,671,785 6/1972 Fuchs et al. .... 128/36 X
- 5,065,743 11/1991 Sutherland ..... 128/59 X

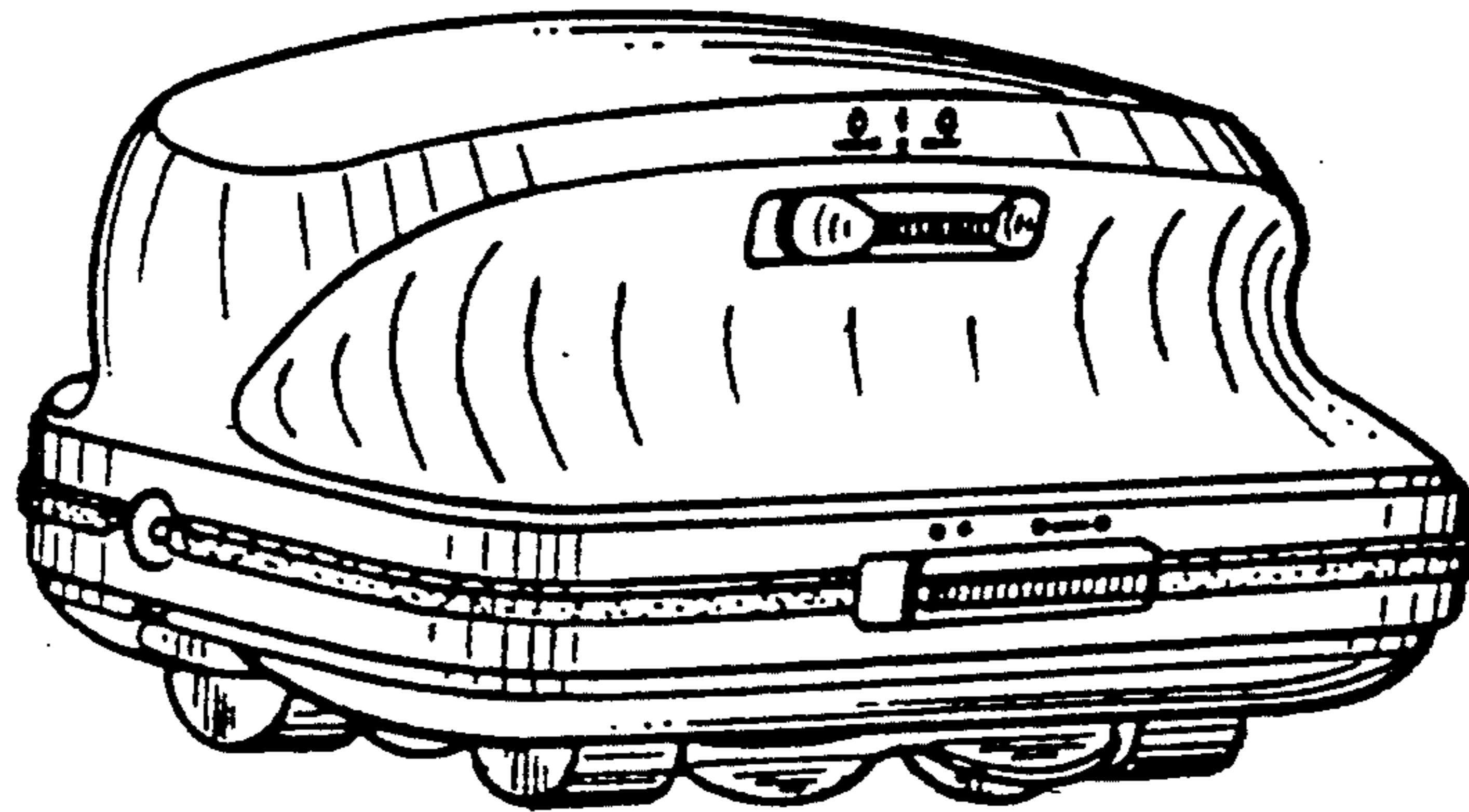
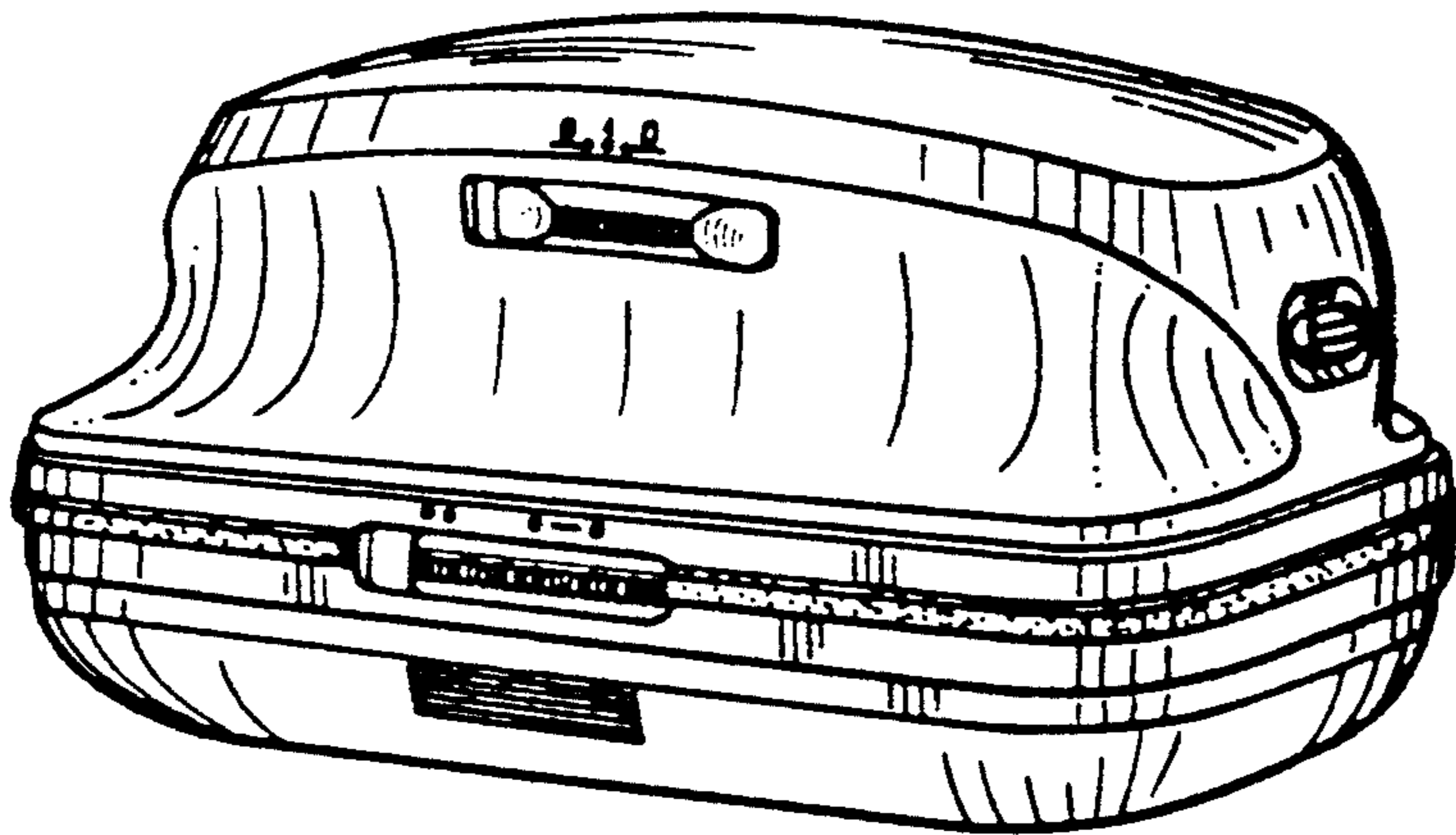

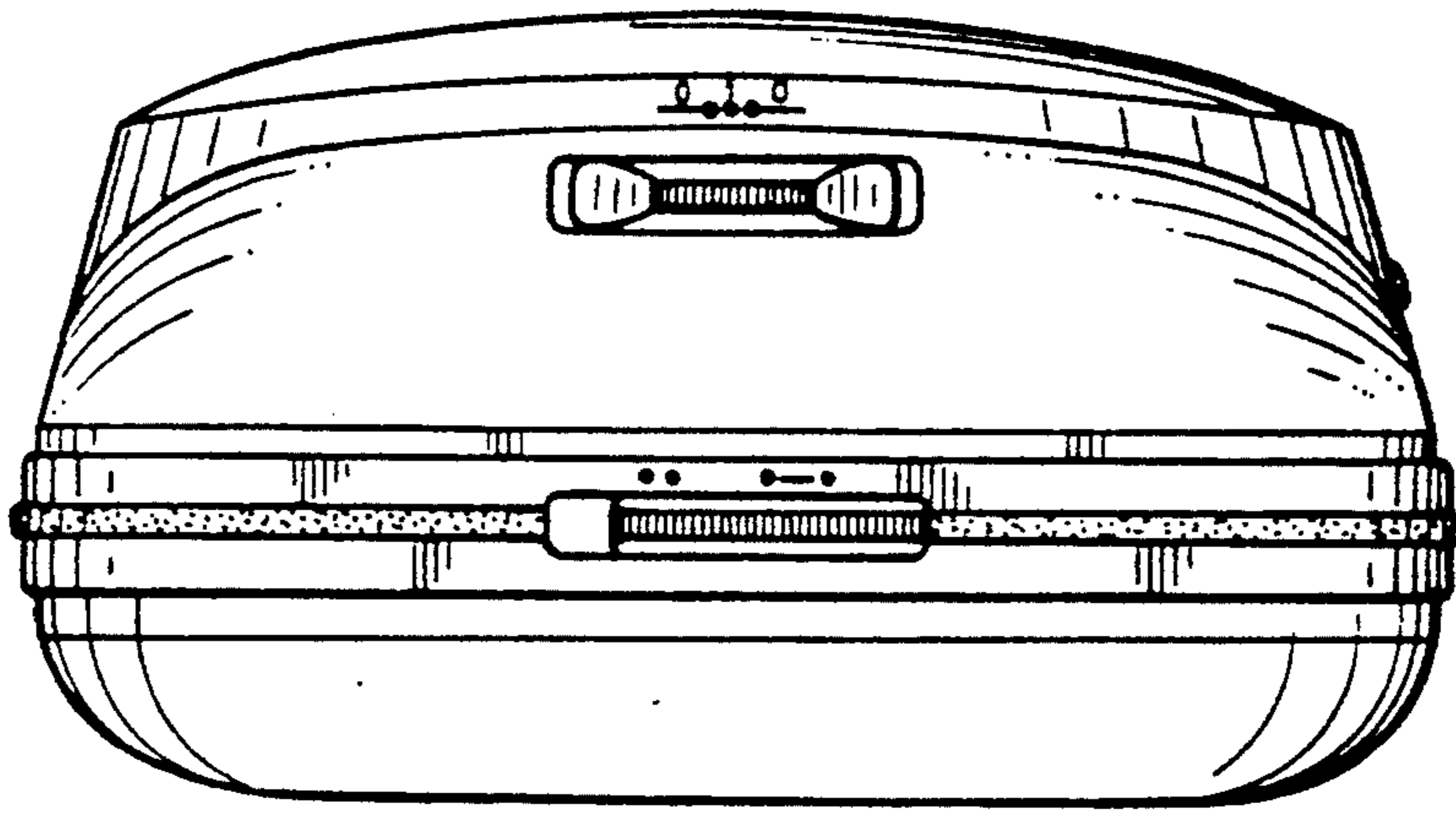

FIG. 1

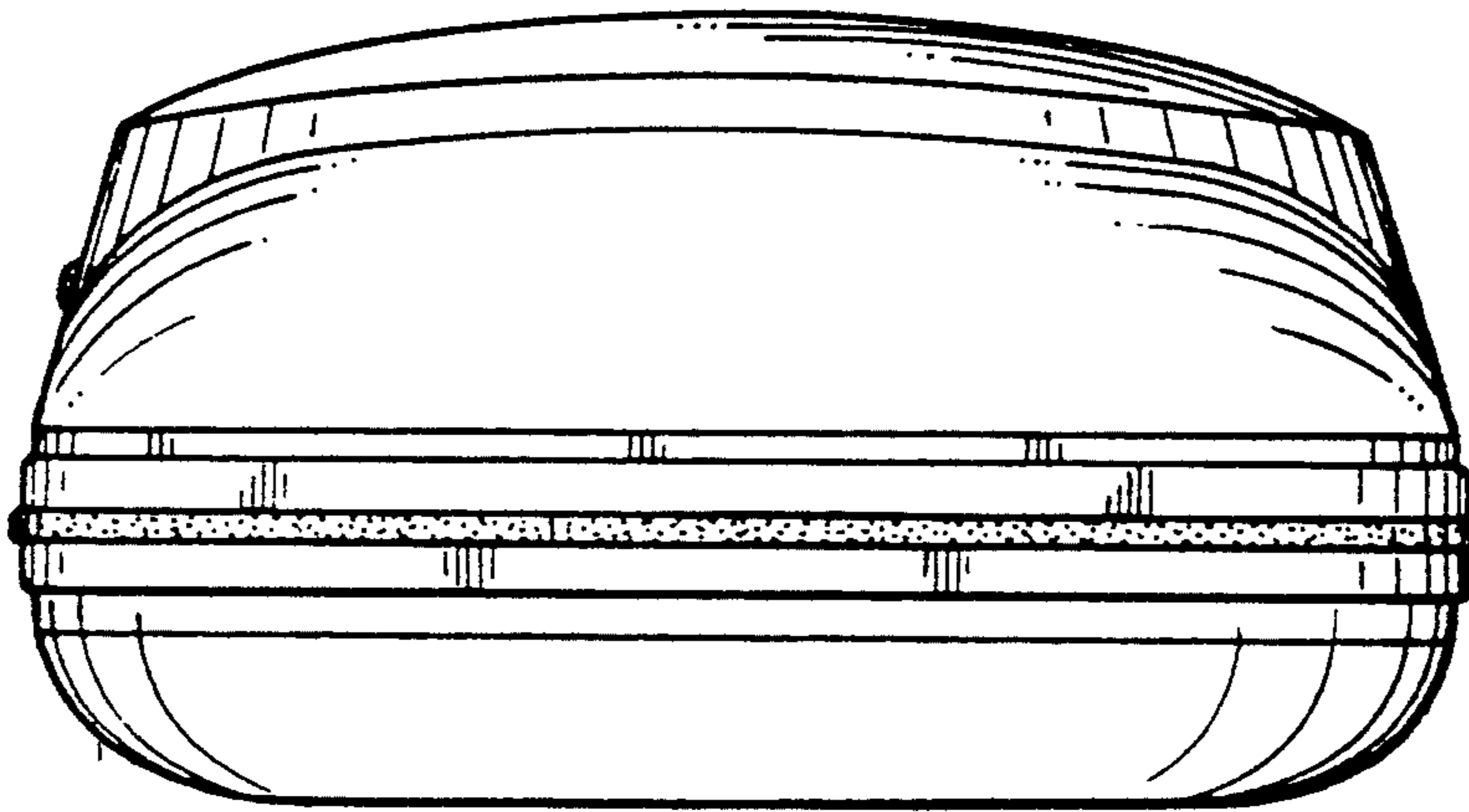

FIG. 2

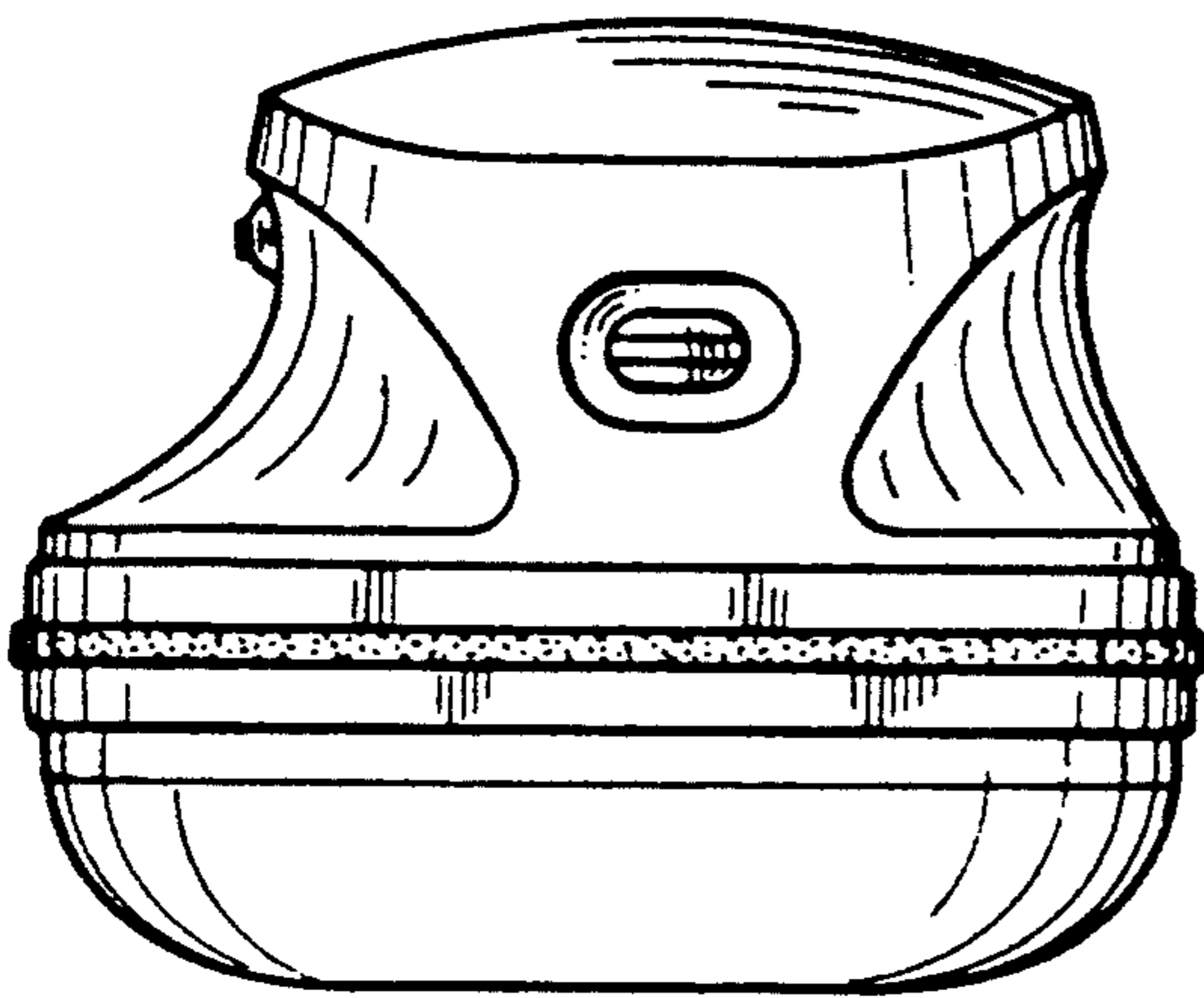

FIG. 3

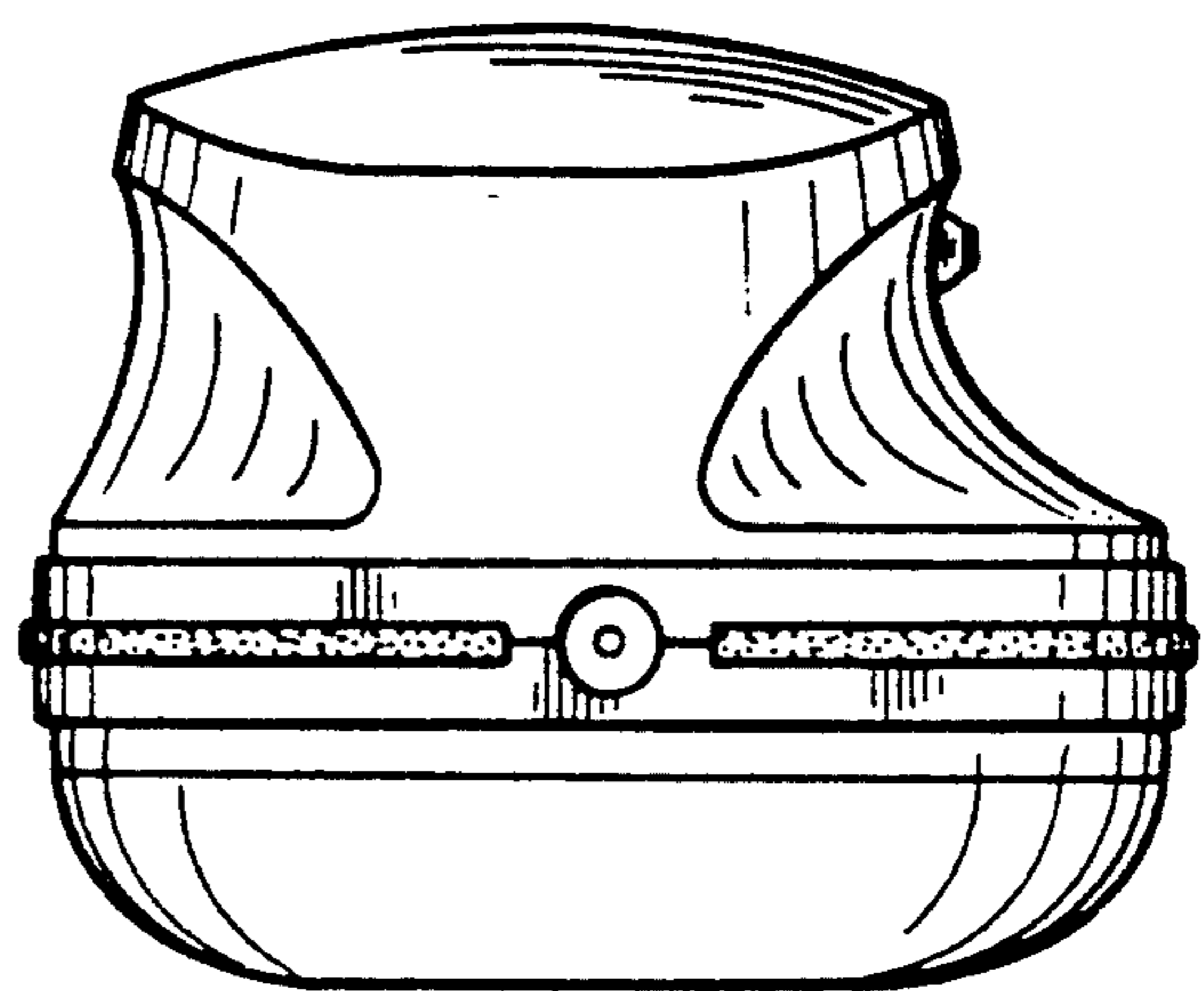

FIG. 4

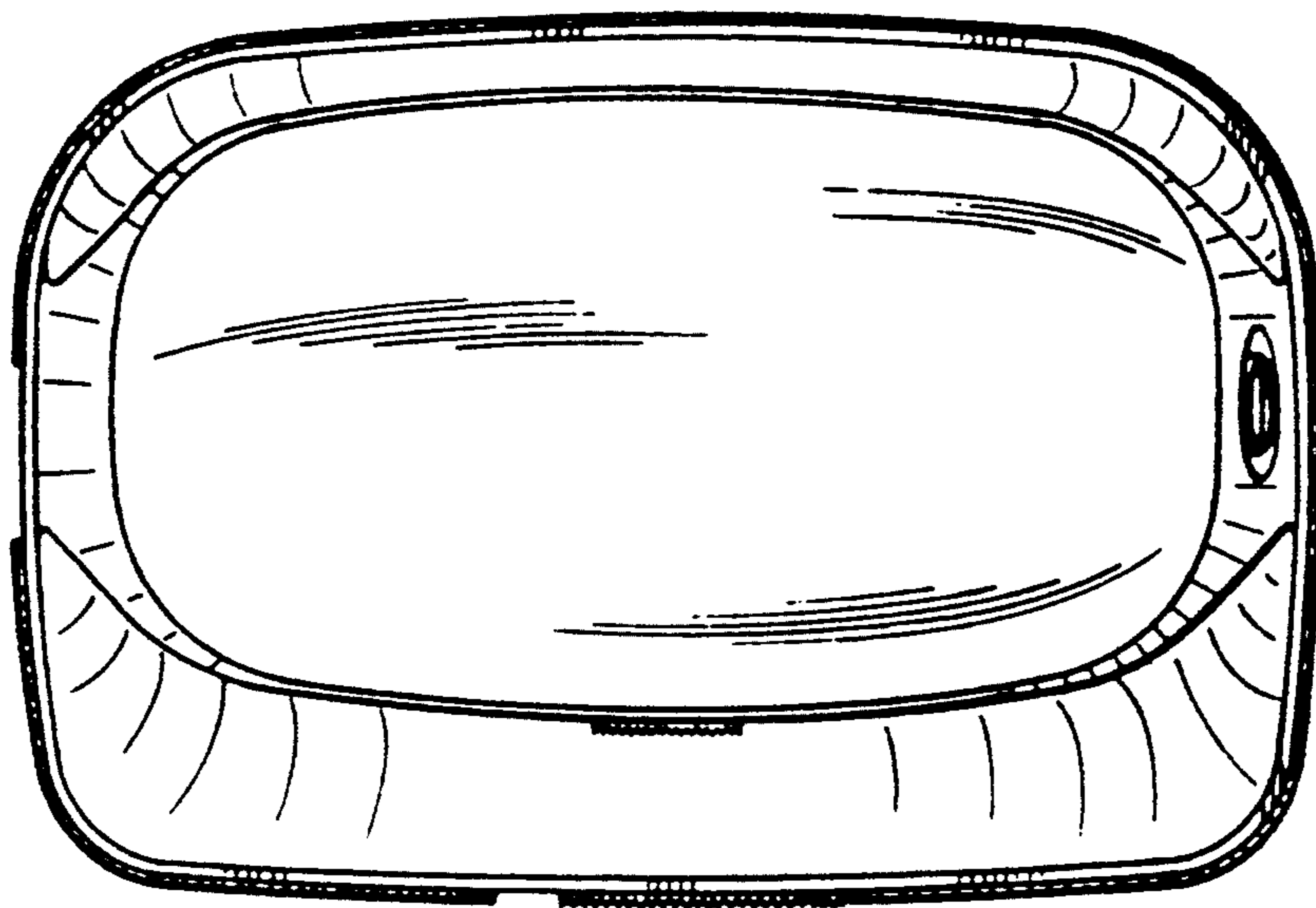

FIG. 5

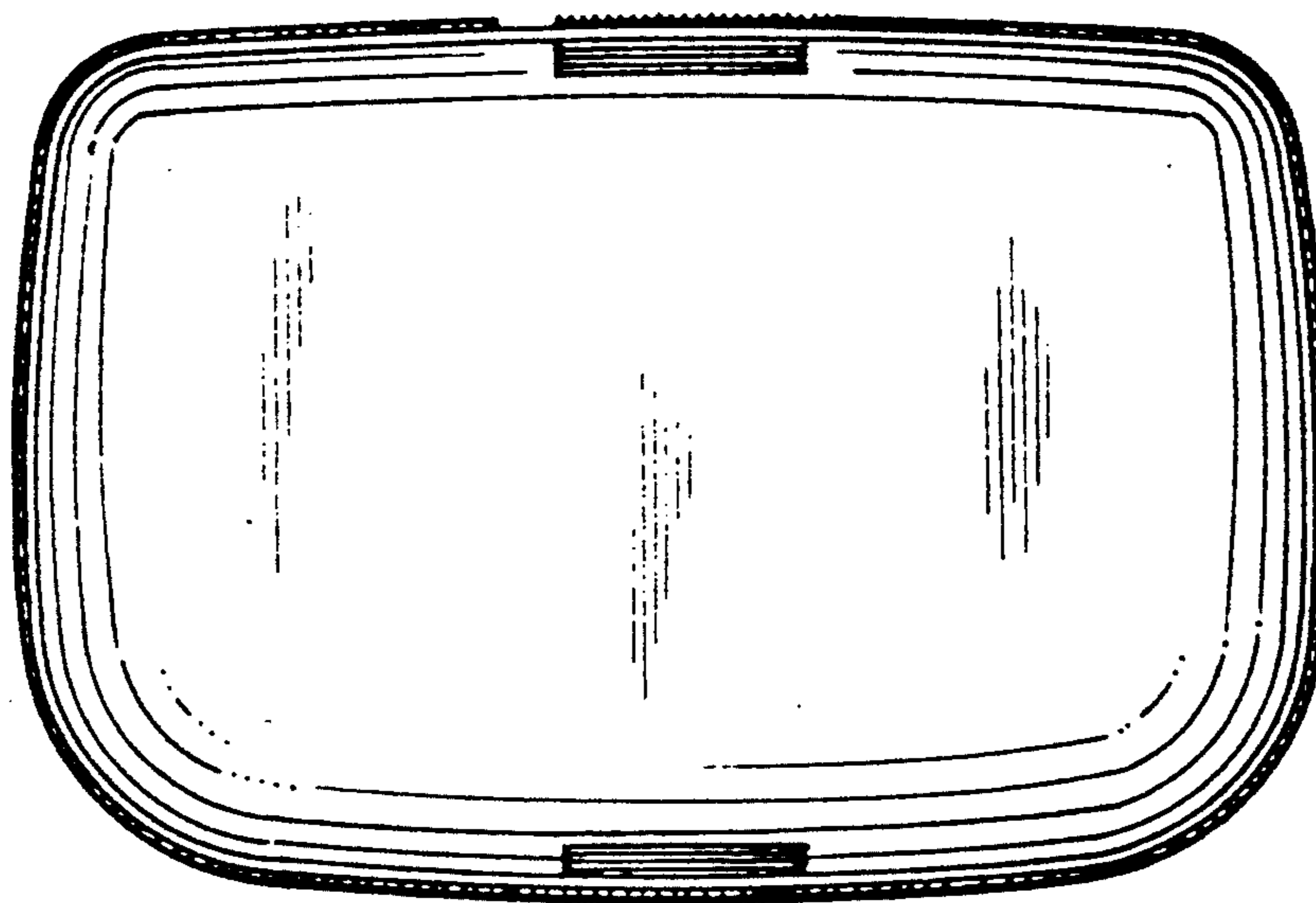

FIG. 6

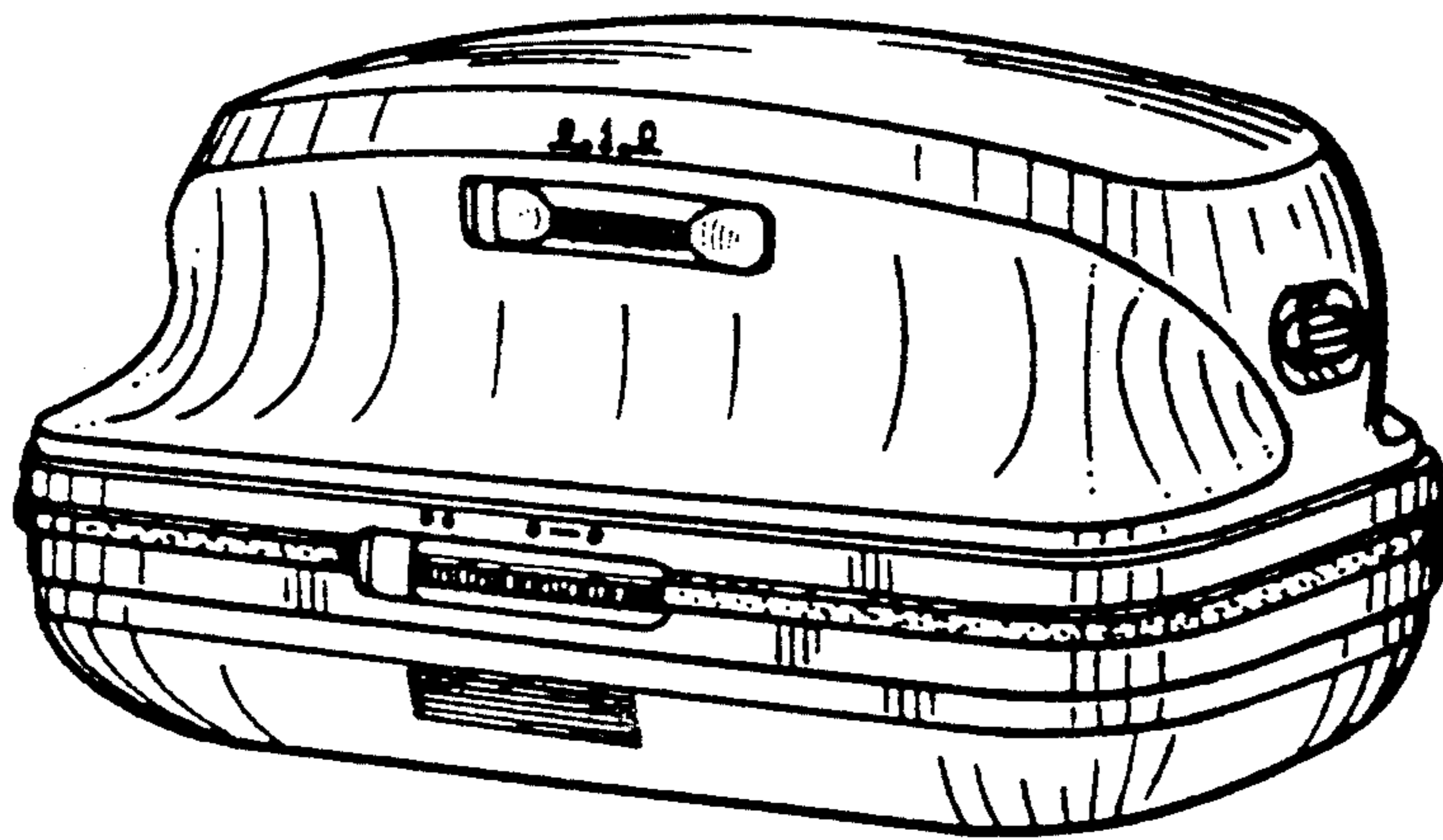

FIG. 7

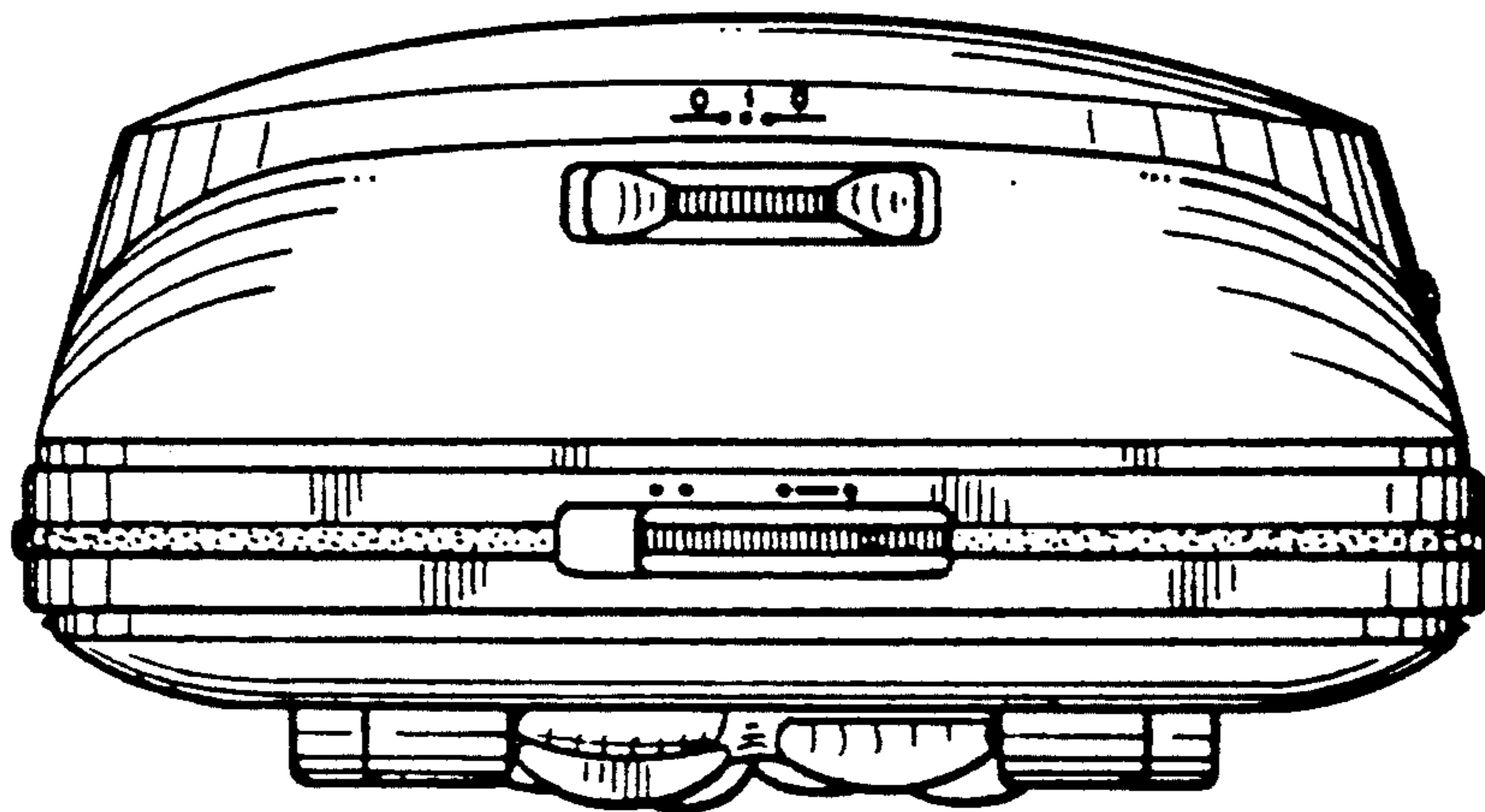

FIG. 8

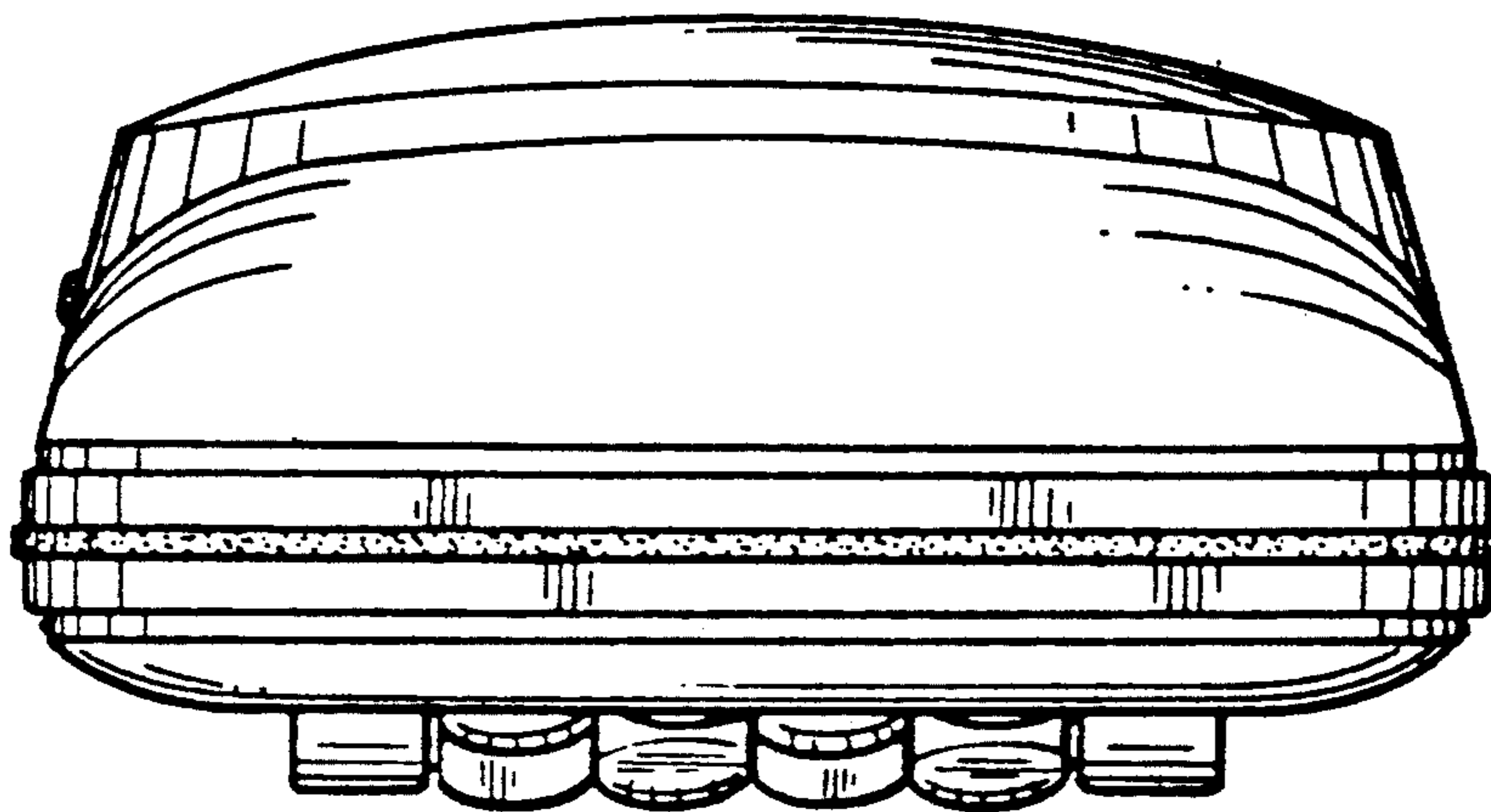

FIG. 9

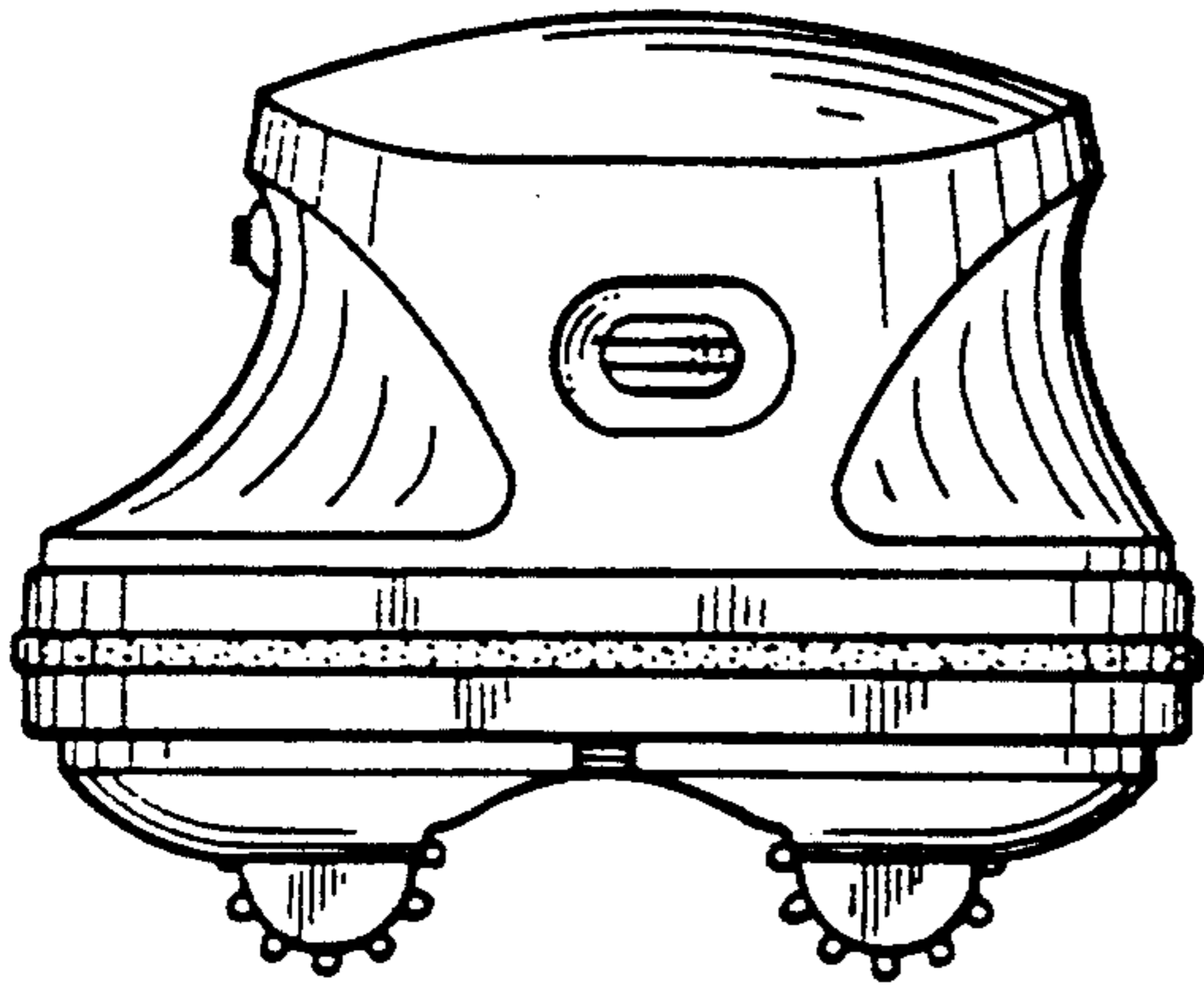

FIG. 10

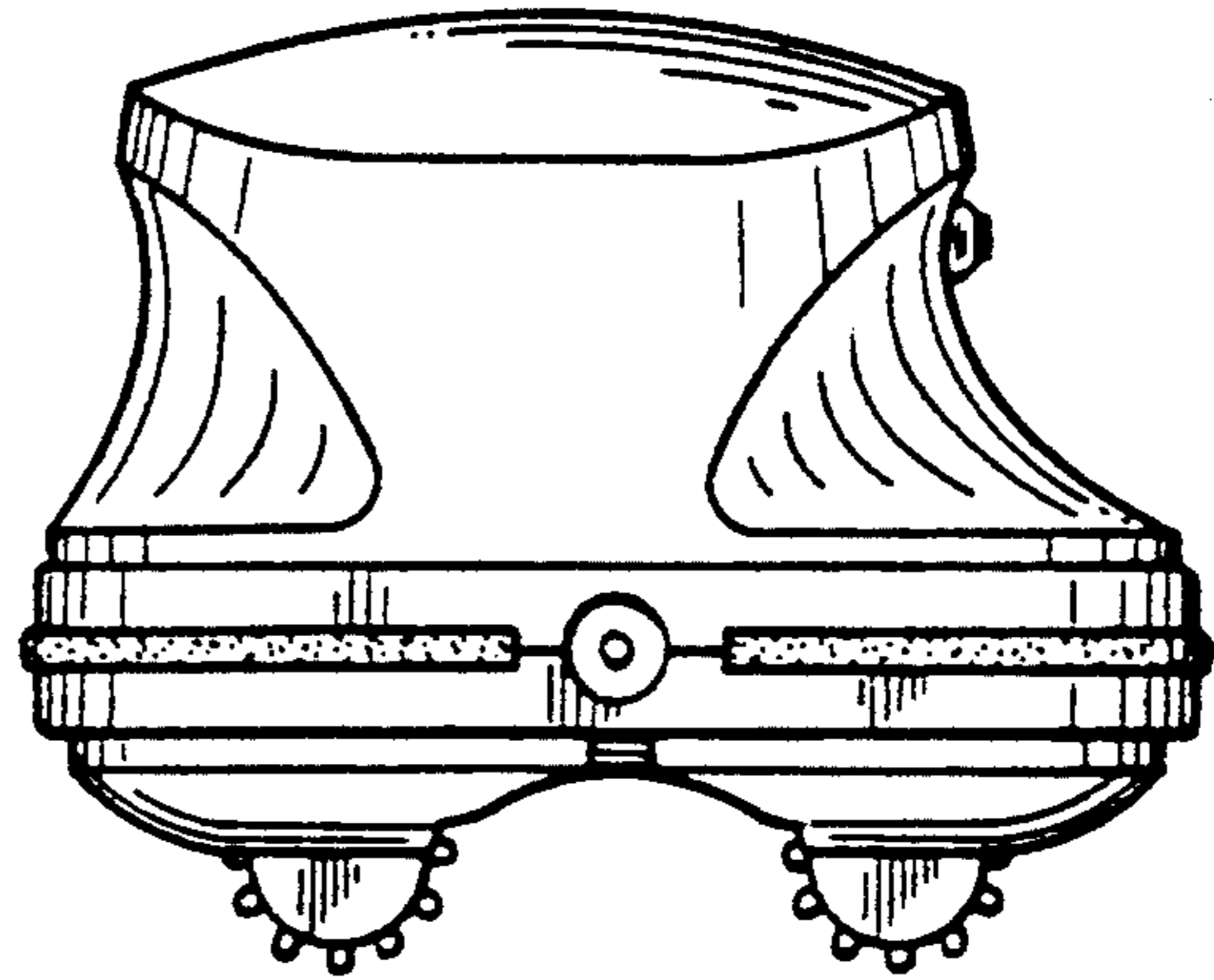

FIG. 11

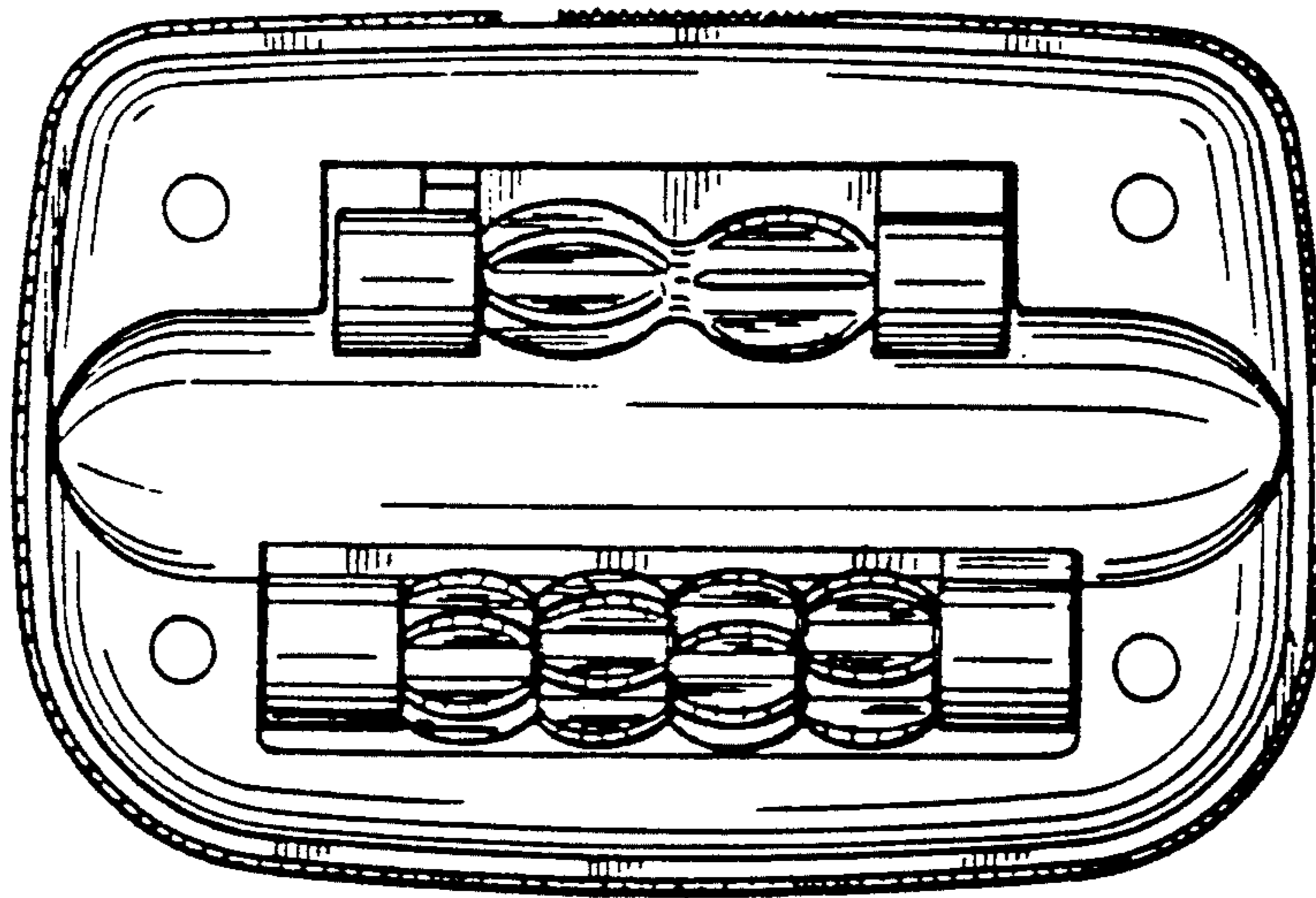

FIG. 12

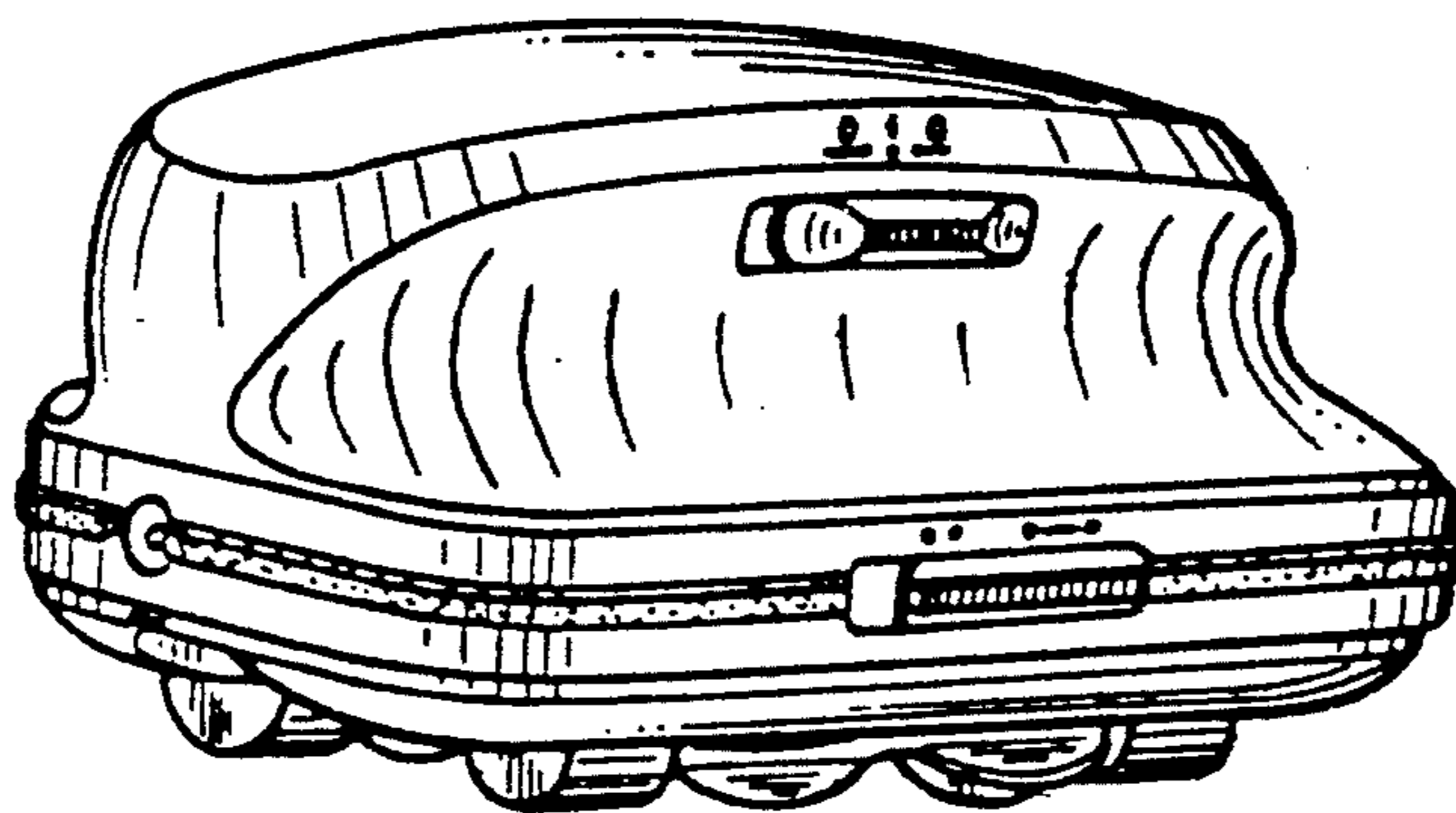

FIG. 13

UNITED STATES PATENT AND TRADEMARK OFFICE  
CERTIFICATE OF CORRECTION

PATENT NO. : Des. 345,424  
DATED : March 22, 1994  
INVENTOR(S) : Jacques GUDEFIN

It is certified that error appears in the above—identified patent and that said Letters Patent is hereby corrected as shown below:

On the title page, in Item [19], change the inventor's surname from "Gudeein" to --Gudefin--.

On the title page, in Item [75], change the inventor's surname from "Gudeein" to --Gudefin--.

Signed and Sealed this  
Twelfth Day of July, 1994



BRUCE LEHMAN

Commissioner of Patents and Trademarks

Attest:

Attesting Officer