



US00D345396S

United States Patent [19]

[11] Patent Number: **Des. 345,396**

Delaney

[45] Date of Patent: **** Mar. 22, 1994**

[54] **AMUSEMENT SPACE VEHICLE**

D. 276,041 10/1984 Reyes D12/343

[75] Inventor: **Timothy J. Delaney**, Northridge, Calif.

OTHER PUBLICATIONS

"The Art of Star Wars," Ballentine Books, pp. 110, 112, 118, 119, 120, 141 and 149 1st ed. (1979).

[73] Assignee: **The Walt Disney Company**, Burbank, Calif.

Primary Examiner—Kay H. Chin
Attorney, Agent, or Firm—Pretty, Schroeder, Brueggemann & Clark

[**] Term: **14 Years**

[21] Appl. No.: **854,261**

[57] **CLAIM**

The ornamental design for an amusement space vehicle, as shown and described.

[22] Filed: **Mar. 20, 1992**

[52] U.S. Cl. **D21/87; D12/319**

[58] Field of Search **244/158 R; D12/319, D12/343, 331, 320, 342; D21/87**

DESCRIPTION

FIG. 1 is a perspective view of an amusement space vehicle embodying my new design; FIG. 2 is a left side elevational view of the vehicle; FIG. 3 is a front elevational view of the vehicle; FIG. 4 is a rear elevational view of the vehicle; FIG. 5 is a top plan view of the vehicle; and, FIG. 6 is a bottom plan view of the vehicle.

[56] **References Cited**

U.S. PATENT DOCUMENTS

- D. 178,629 9/1956 Beach, Jr. D21/87
- D. 219,295 11/1970 Rosenthal D21/87
- D. 254,080 1/1980 Johnston D21/87

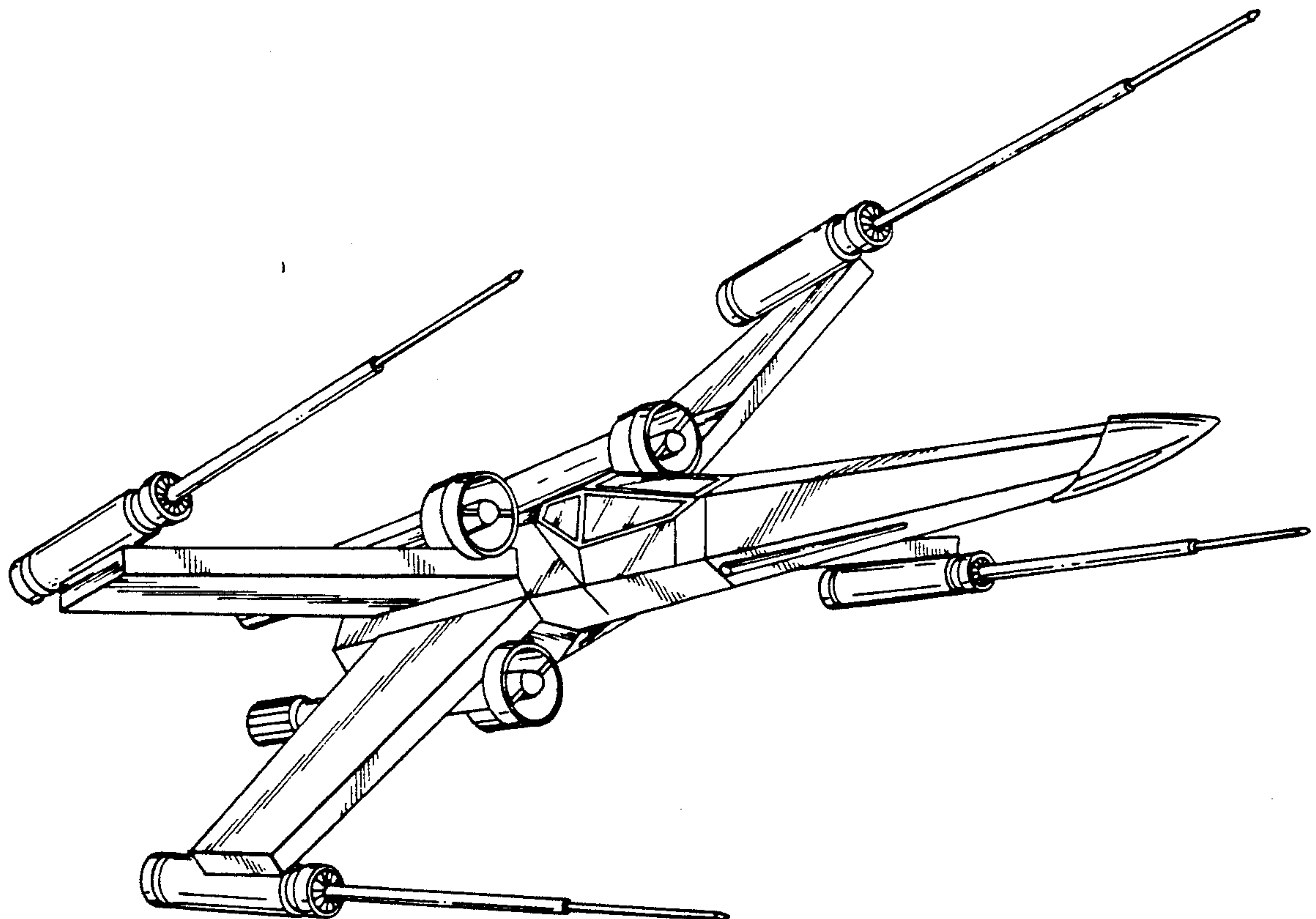

FIG. 1.

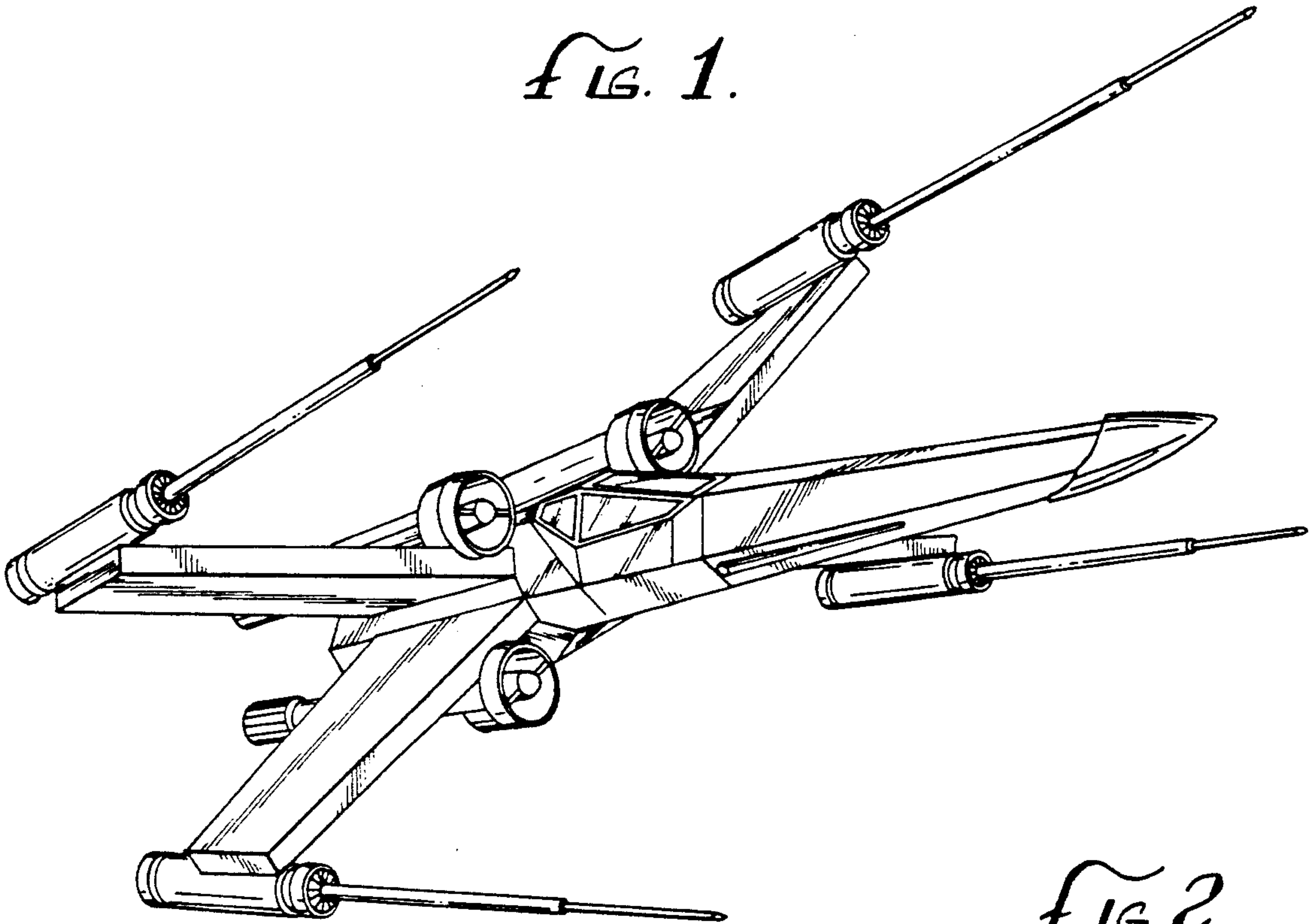

FIG. 2.

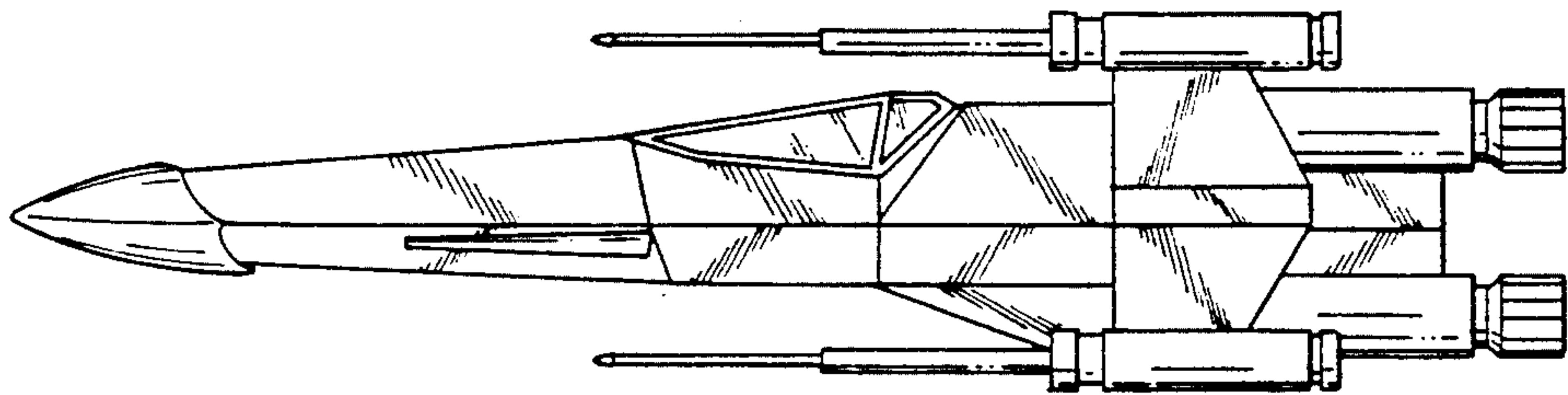

FIG. 3.

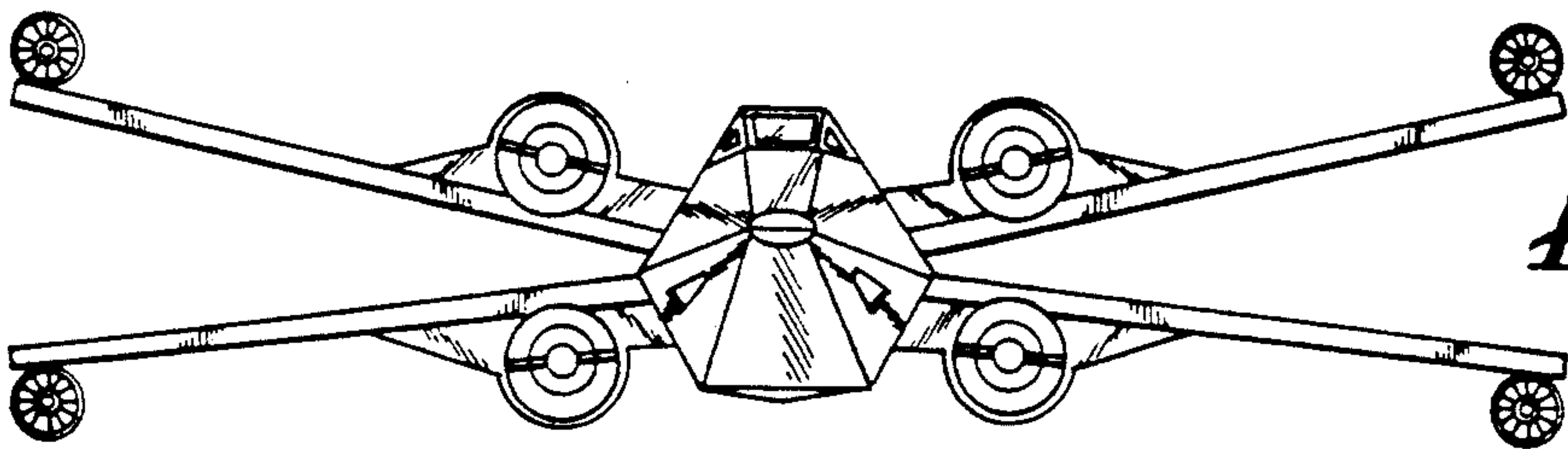
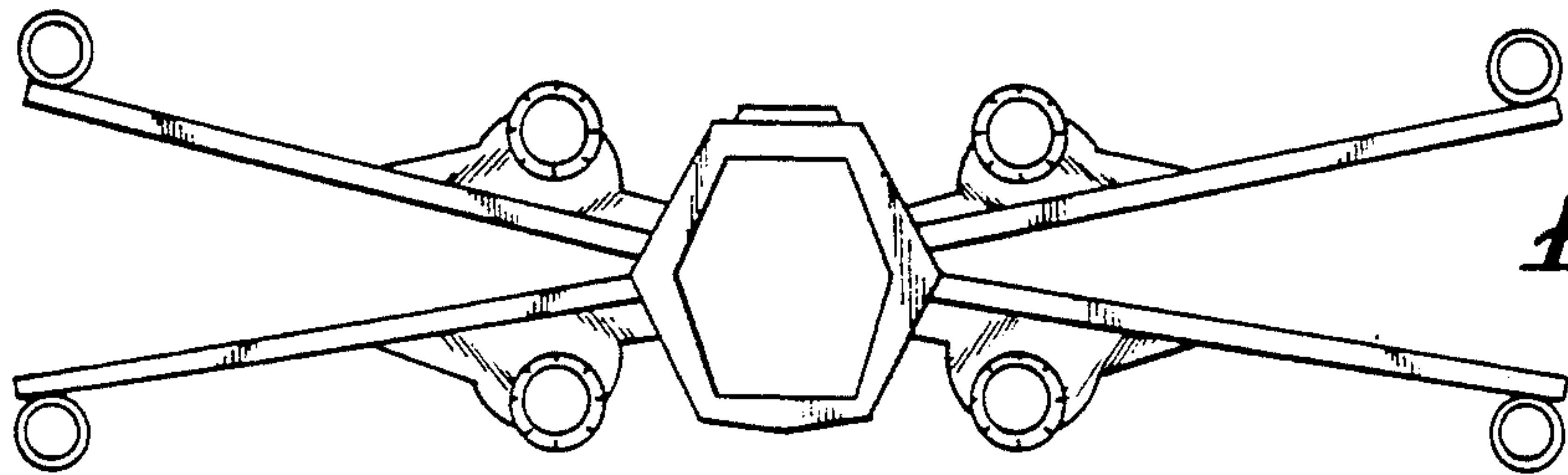

FIG. 4.



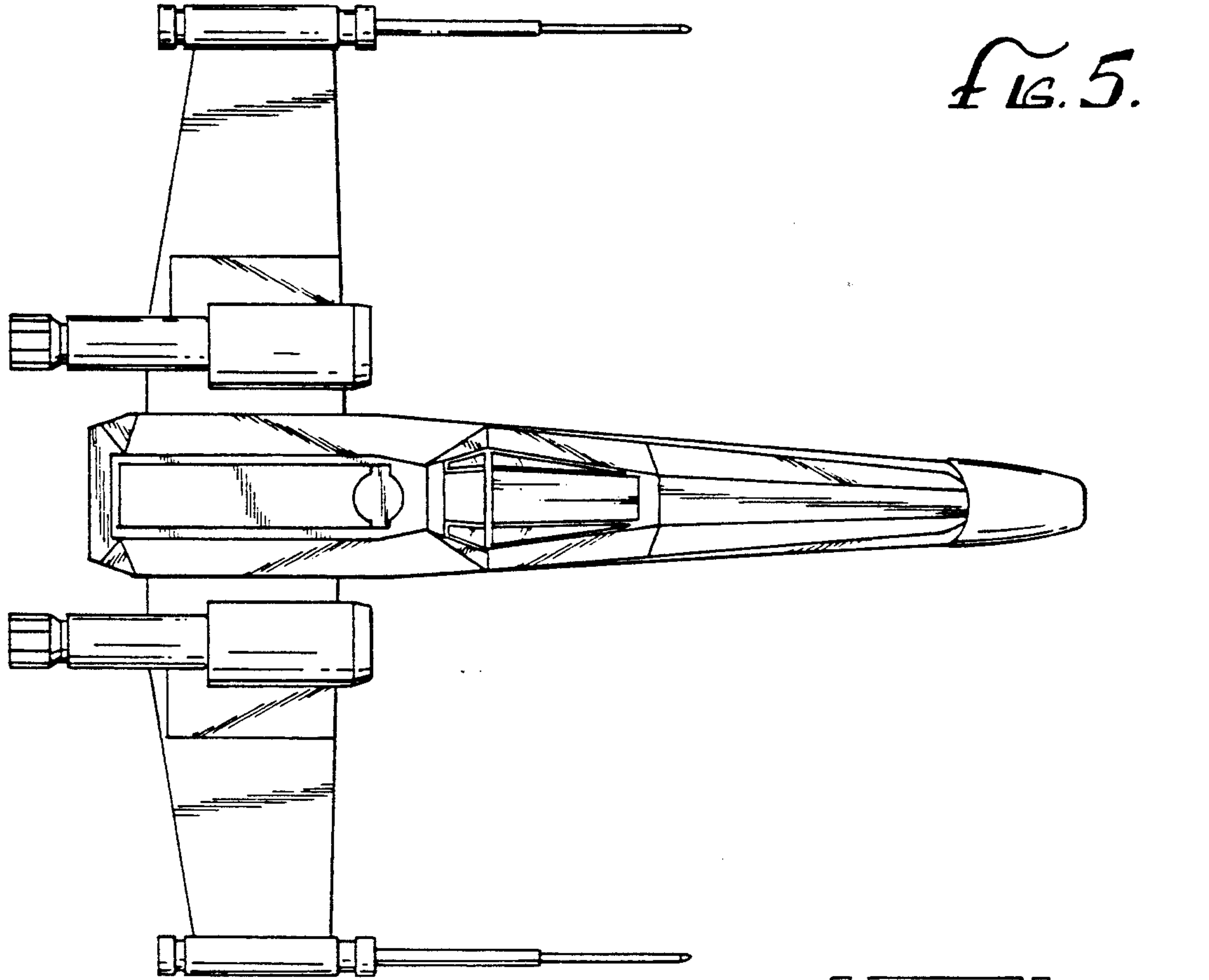

FIG. 5.

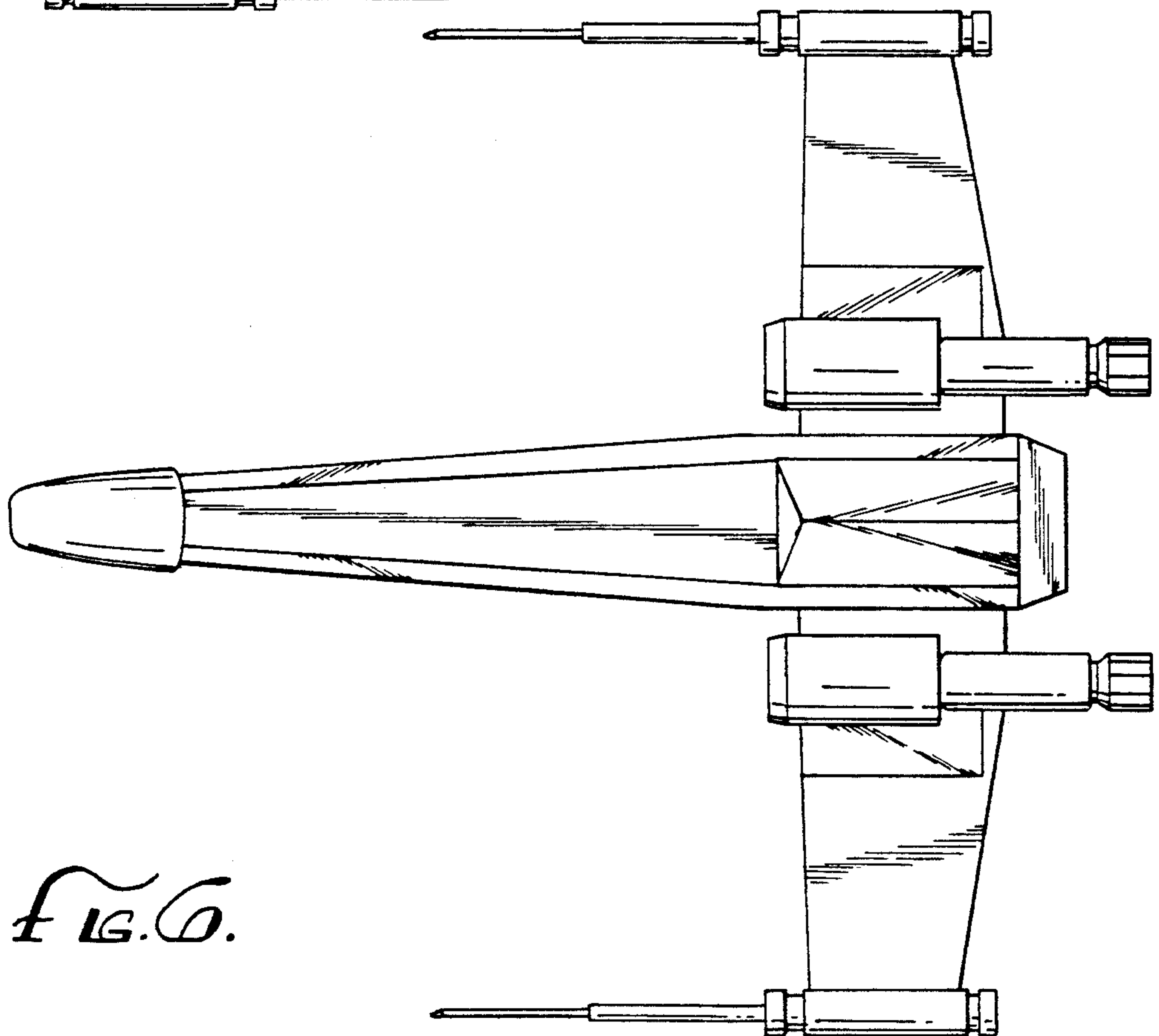

FIG. 6.