



US00D345335S

United States Patent [19]
Montgomery

[11] **Patent Number: Des. 345,335**
[45] **Date of Patent: ** Mar. 22, 1994**

- [54] **TRUCK TAILGATE FAIRING**
- [76] **Inventor: Eddie R. Montgomery, 5016 Fernhill Dr., St. Louis, Mo. 63128**
- [**] **Term: 14 Years**
- [21] **Appl. No.: 860,347**
- [22] **Filed: Mar. 30, 1992**
- [52] **U.S. Cl. D12/196**
- [58] **Field of Search 296/50, 57.1, 60; D12/196, 98**

Heavy-Duty Tailgate Net, top of page & p. 61, Stainless Steel Tailgate Accent Panels, top of page.

Primary Examiner—James M. Gandy
Attorney, Agent, or Firm—Rogers Howell & Haferkamp

[57] **CLAIM**

The ornamental designs for a truck tailgate fairing, as shown and described.

DESCRIPTION

FIG. 1 is a rear perspective view of a truck tailgate fairing showing my new design;
FIG. 2 is a front perspective view thereof;
FIG. 3 is a top plan view thereof;
FIG. 4 is a rear elevation view thereof;
FIG. 5 is a front elevation view thereof;
FIG. 6 is a right side elevation view thereof;
FIG. 7 is a left side elevation view thereof; and,
FIG. 8 is a bottom plan view thereof.

The broken line showing of a truck tailgate in FIGS. 1, 2, 4 and 5 of the drawing is for illustrative purposes only and forms no part of the claimed design.

[56] **References Cited**

U.S. PATENT DOCUMENTS

D. 295,278	4/1988	Smith	D12/196
4,763,944	8/1988	Fry et al.	296/50
4,902,066	2/1990	Norman	296/57.1
4,932,705	6/1990	Miller	296/50
5,110,172	5/1992	Ney et al.	296/50

OTHER PUBLICATIONS

J. C. Whitney catalog No. 515J, ©1990, p. 60,

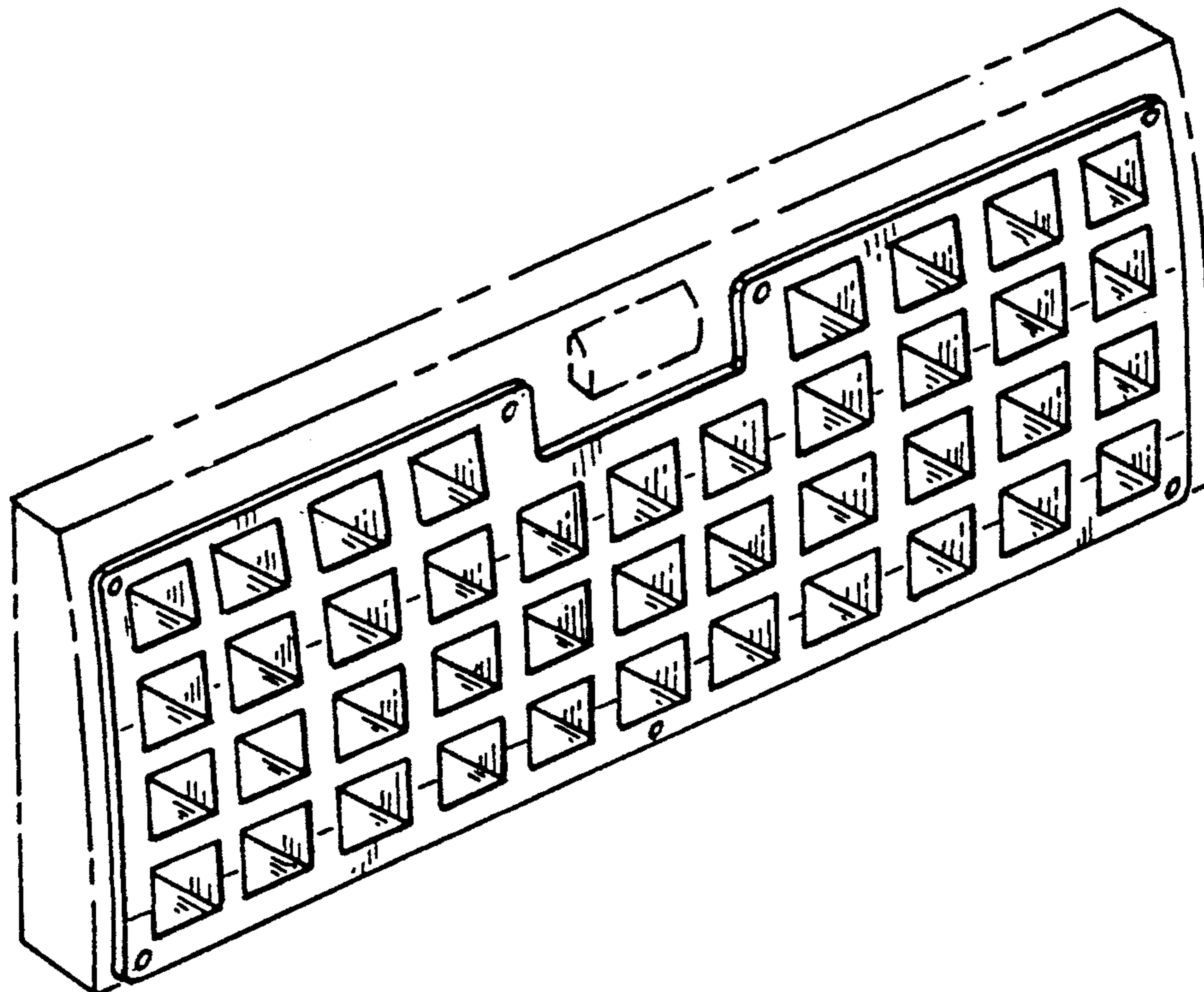

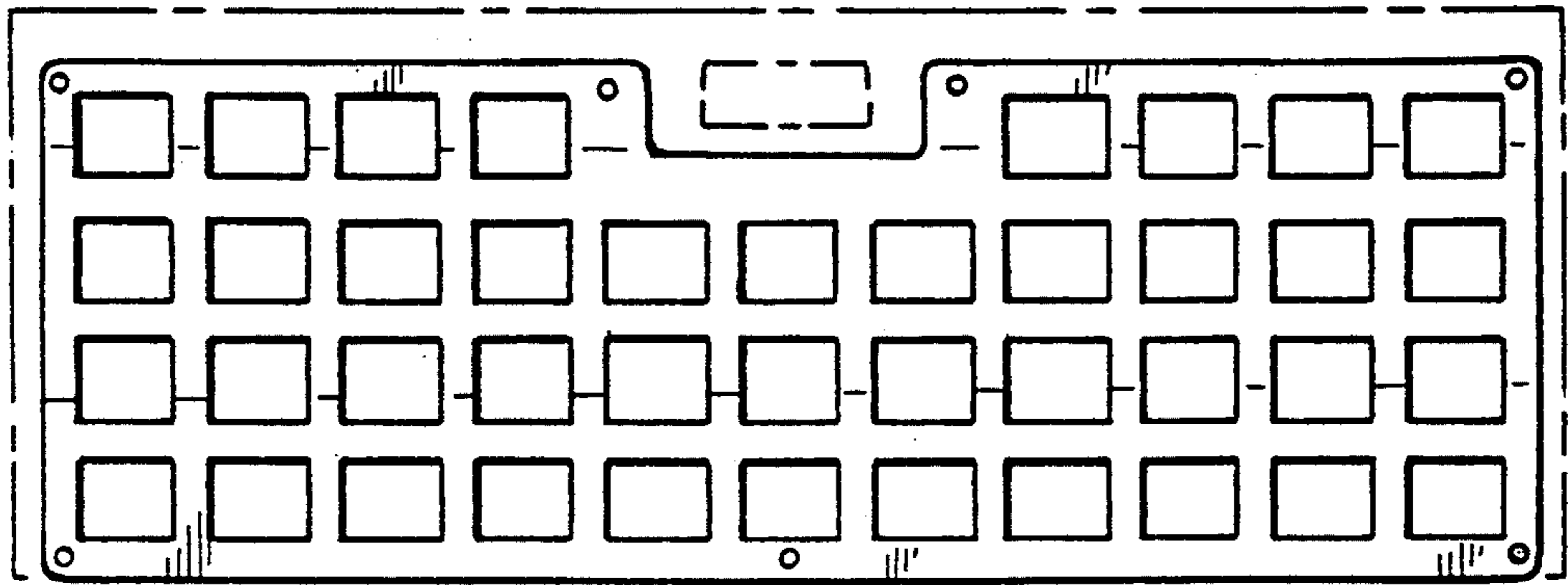
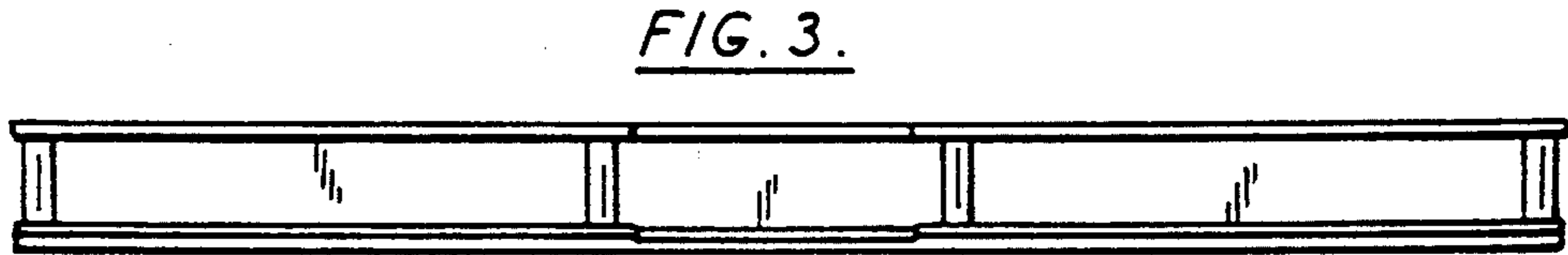
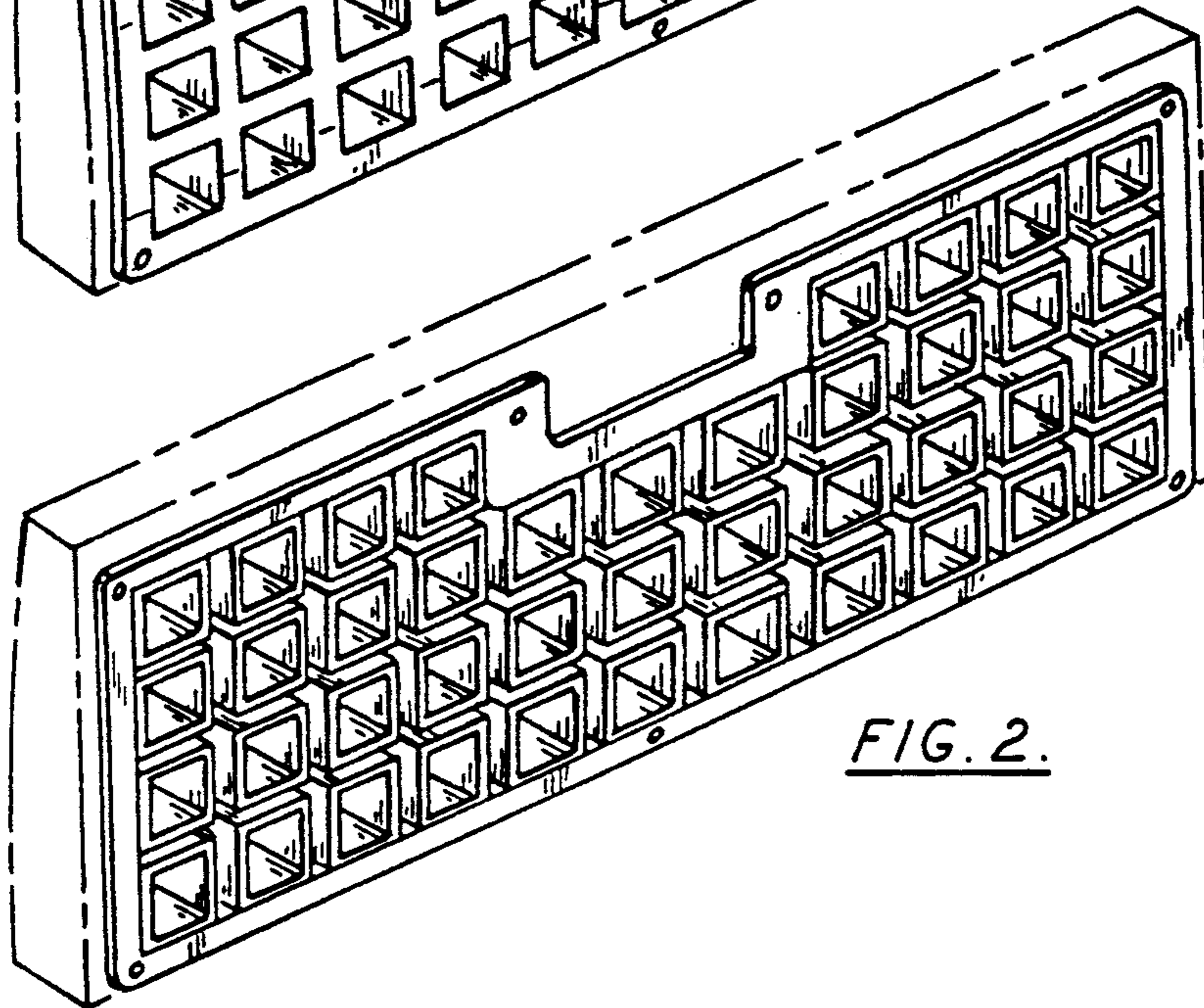
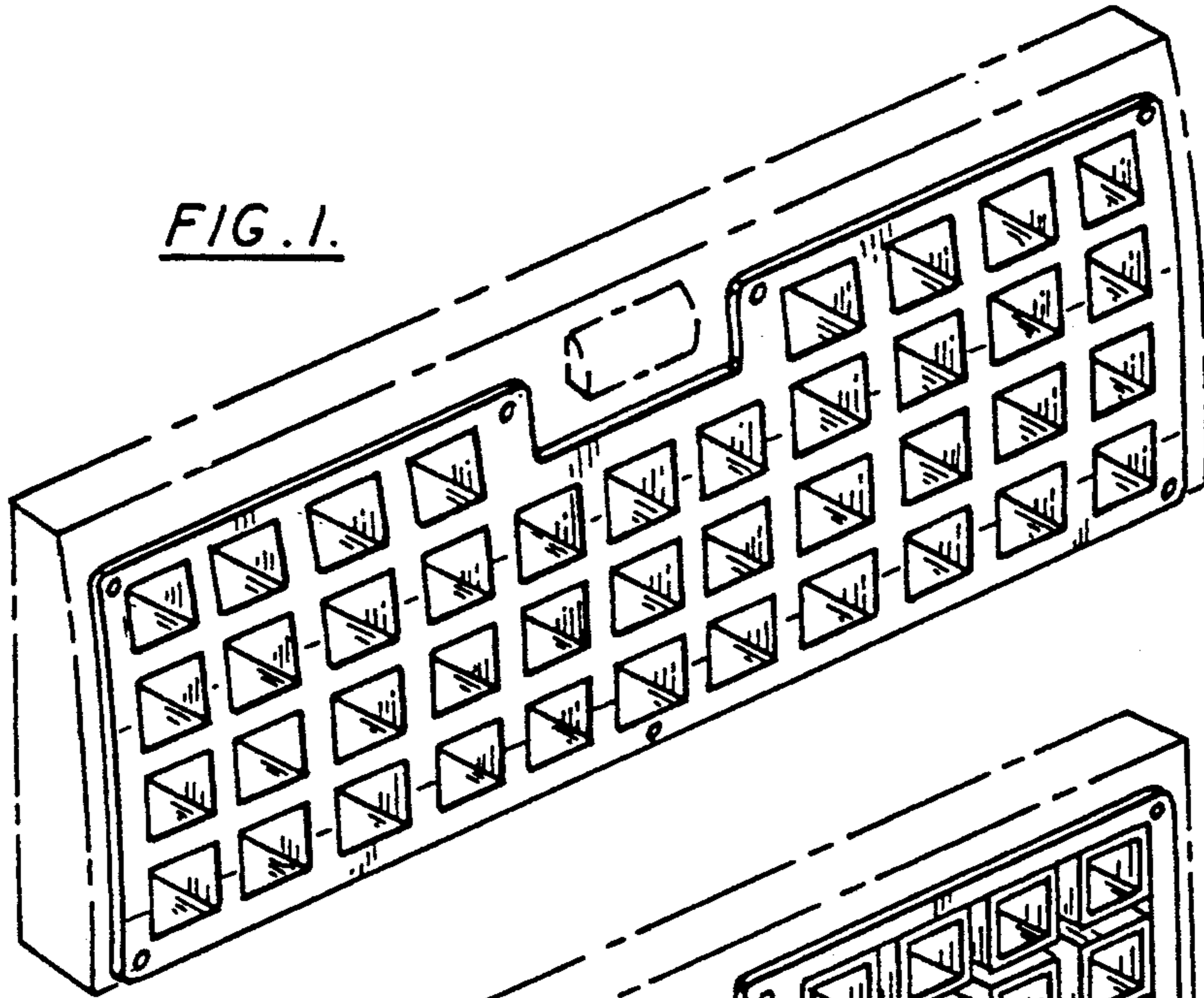

FIG. 5.

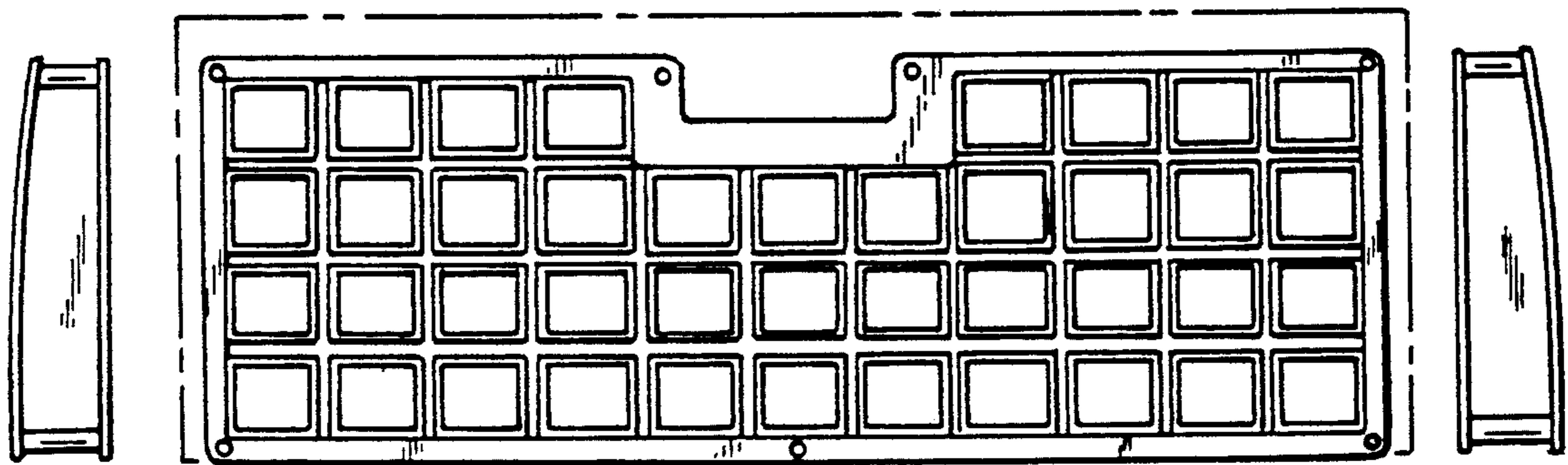

FIG. 6.



FIG. 7.

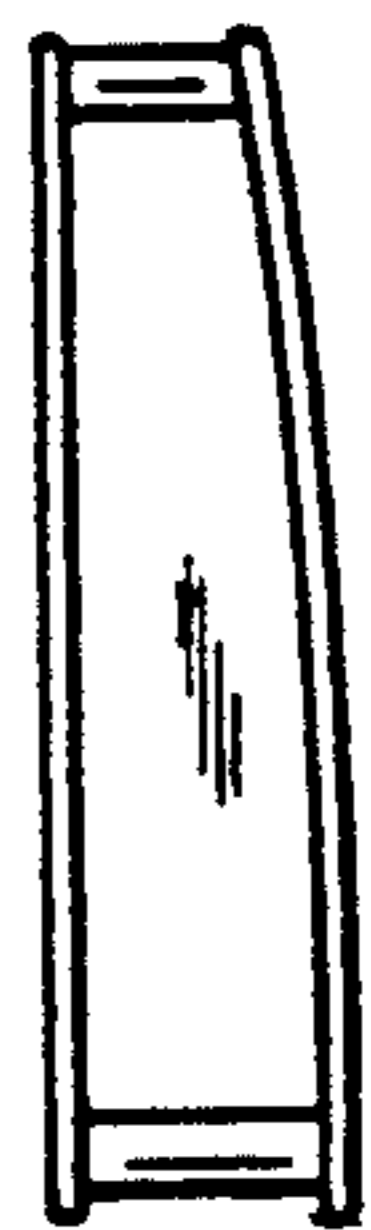

FIG. 8.

