



US00D345308S

United States Patent [19]

[11] Patent Number: **Des. 345,308**

Kanai

[45] Date of Patent: **** Mar. 22, 1994**

[54] **CLOCK**

2,652,745	9/1953	Quinn	368/79
2,726,571	12/1955	Chang	368/79
2,875,668	3/1959	McKenzie	368/227 X
3,136,210	6/1964	Barrett	368/79

[75] Inventor: **Hiromi Kanai, Tokyo, Japan**

[73] Assignee: **Matsubara Denki Kogyo Kabushiki Kaisha, Japan**

[**] Term: **14 Years**

[21] Appl. No.: **829,678**

[22] Filed: **Feb. 3, 1992**

[30] **Foreign Application Priority Data**

Sep. 2, 1991 [JP] Japan 3-26392

[52] U.S. Cl. **D10/26**

[58] Field of Search 368/79, 227, 239, 285;
D10/1-40, 122-132

[56] **References Cited**

U.S. PATENT DOCUMENTS

740,433	10/1903	Hirth	368/227
818,836	2/1906	Smith	368/79
2,290,811	7/1942	Nassoit	368/227 X
2,486,425	11/1949	Loewe	368/227 X

Primary Examiner—Nelson C. Holtje
Assistant Examiner—Martie Thompson
Attorney, Agent, or Firm—Kinzer, Plyer, Dorn,
McEachran & Jambor

[57] CLAIM

The ornamental design for a clock, as shown and described.

DESCRIPTION

FIG. 1 is a front elevational view of a clock showing my new design;
FIG. 2 is a rear elevational view;
FIG. 3 is a left side elevational view;
FIG. 4 is a right side elevational view;
FIG. 5 is a top plan view;
FIG. 6 is a bottom plan view; and,
FIG. 7 is a perspective view thereof in an alternate position.

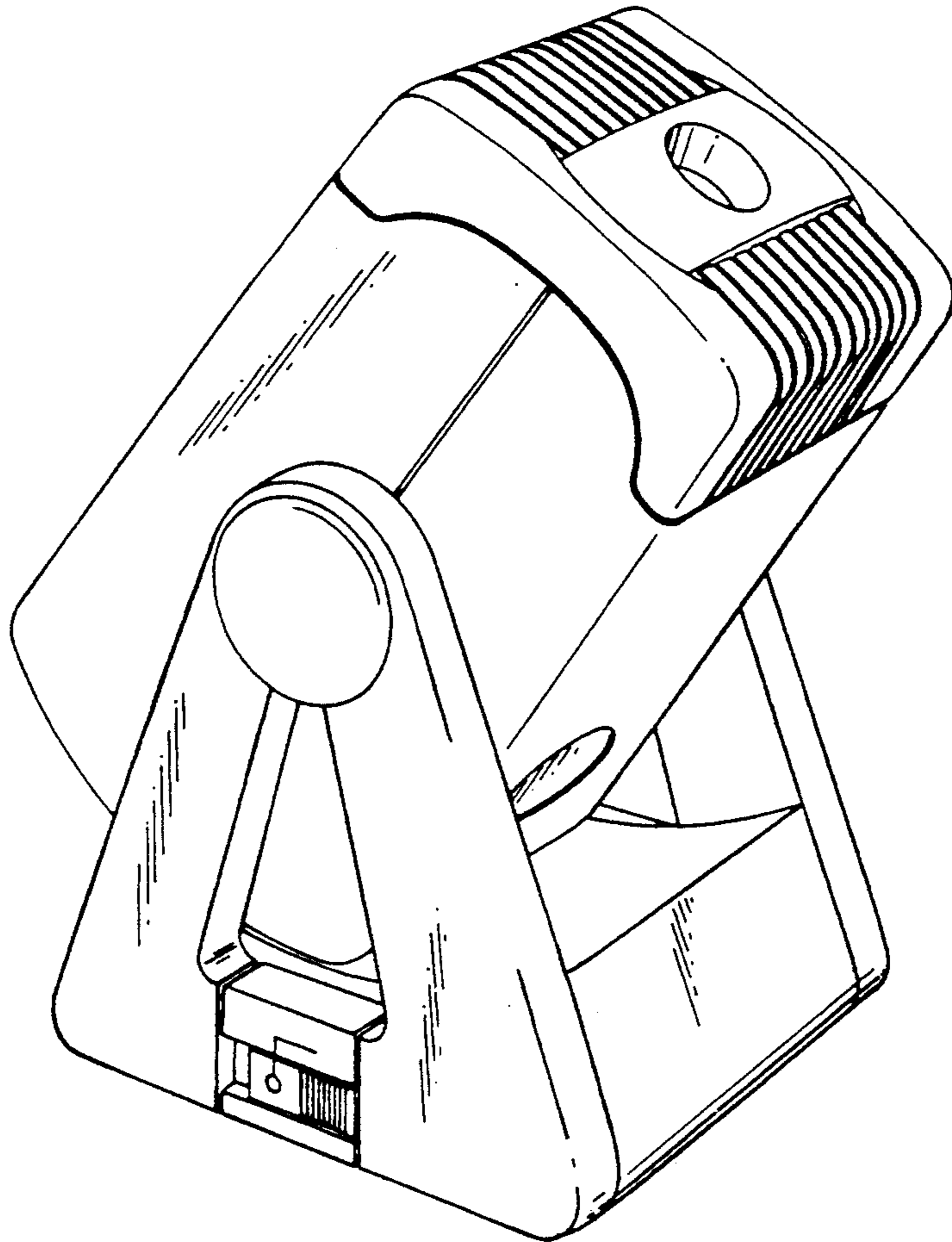

FIG. 1

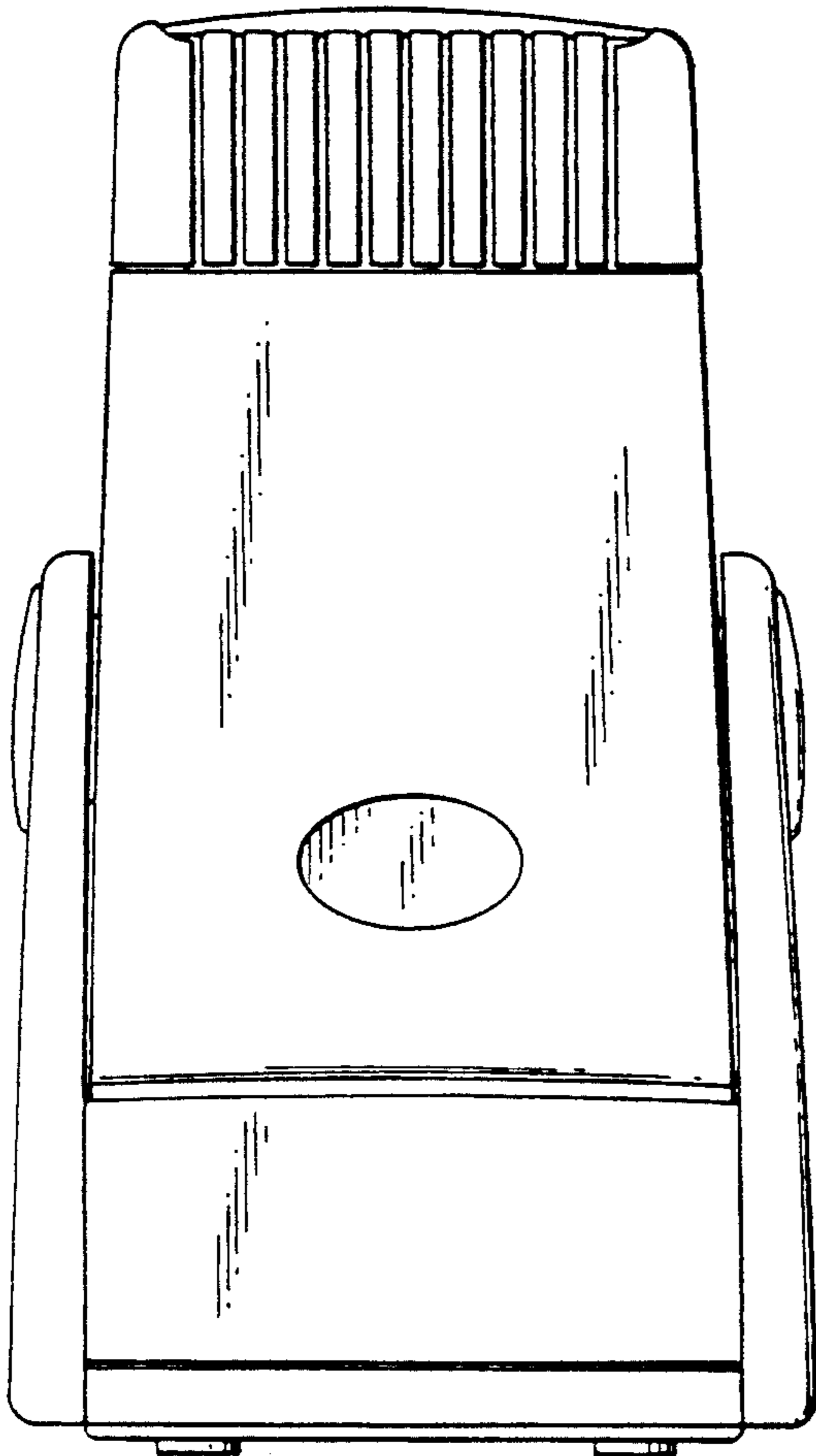

FIG. 2

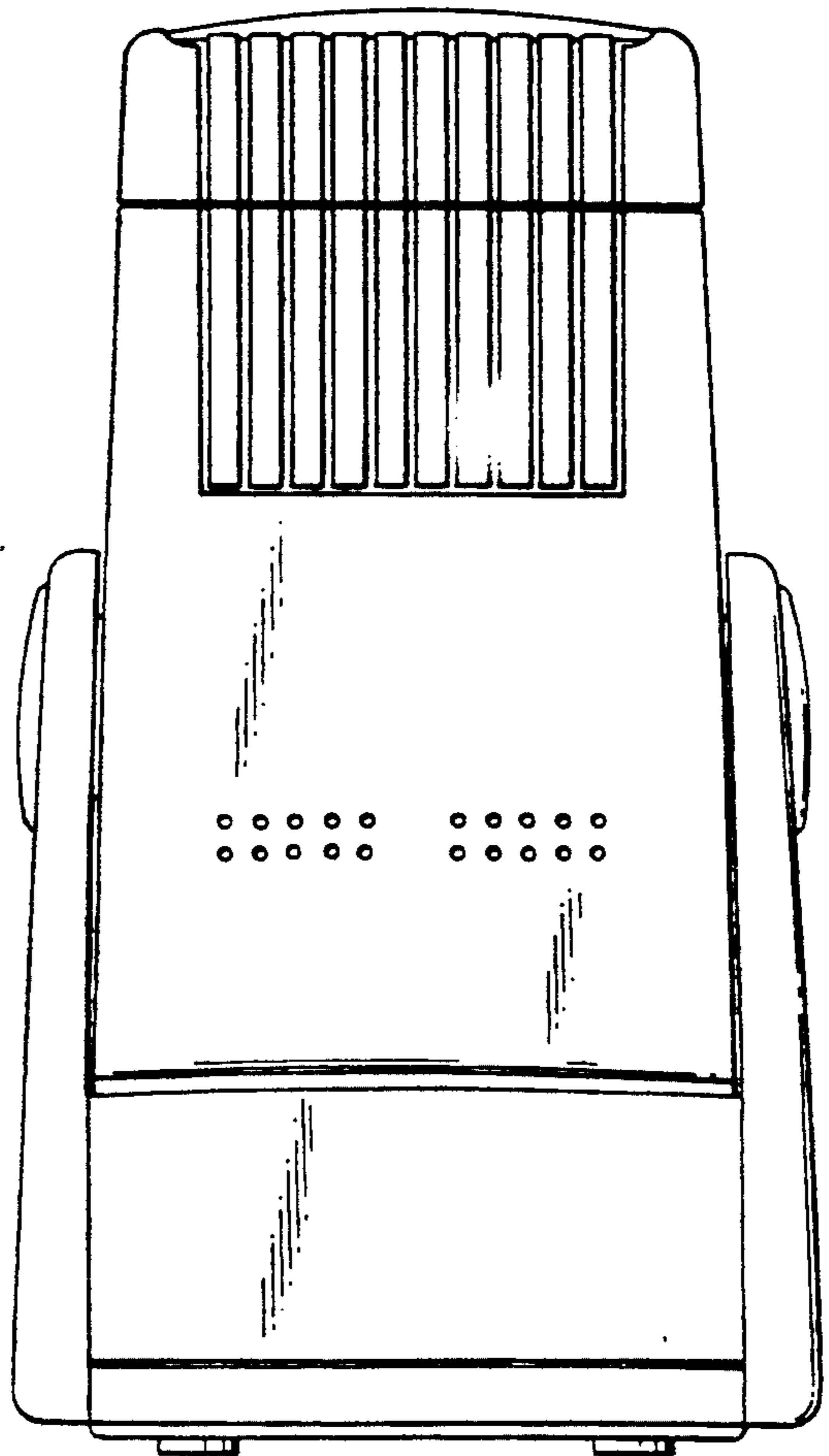

FIG. 3

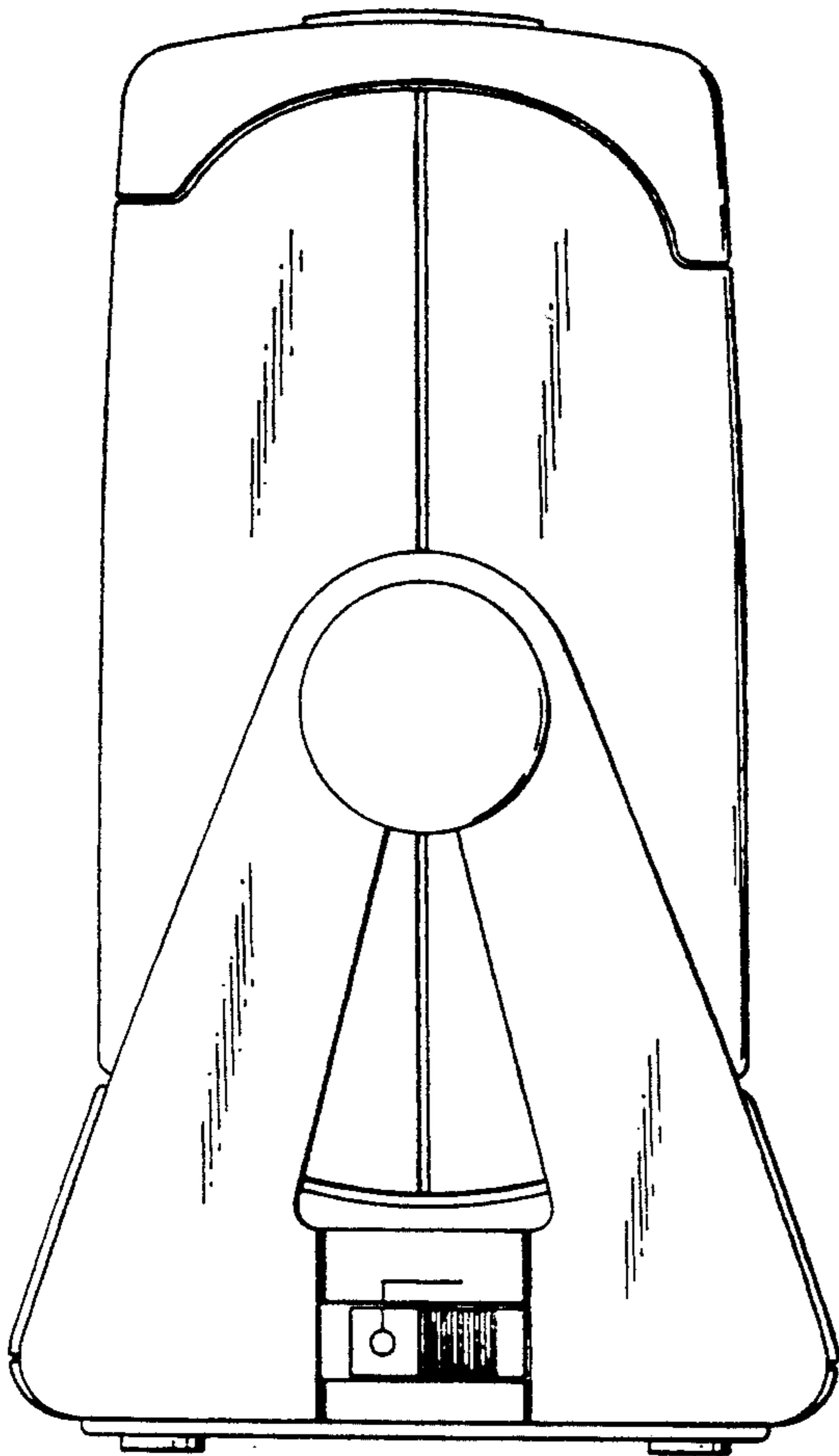

FIG. 4

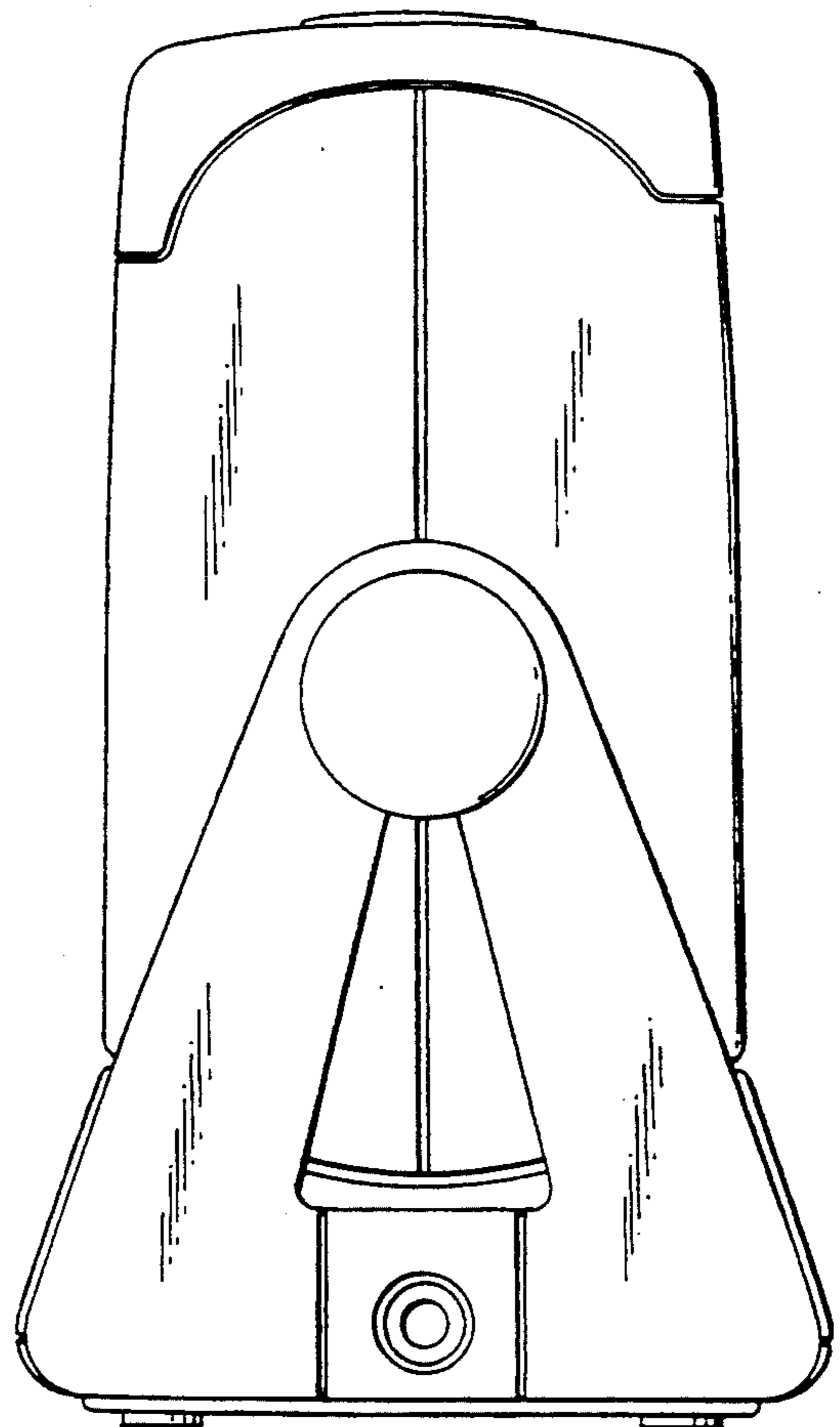

FIG. 5

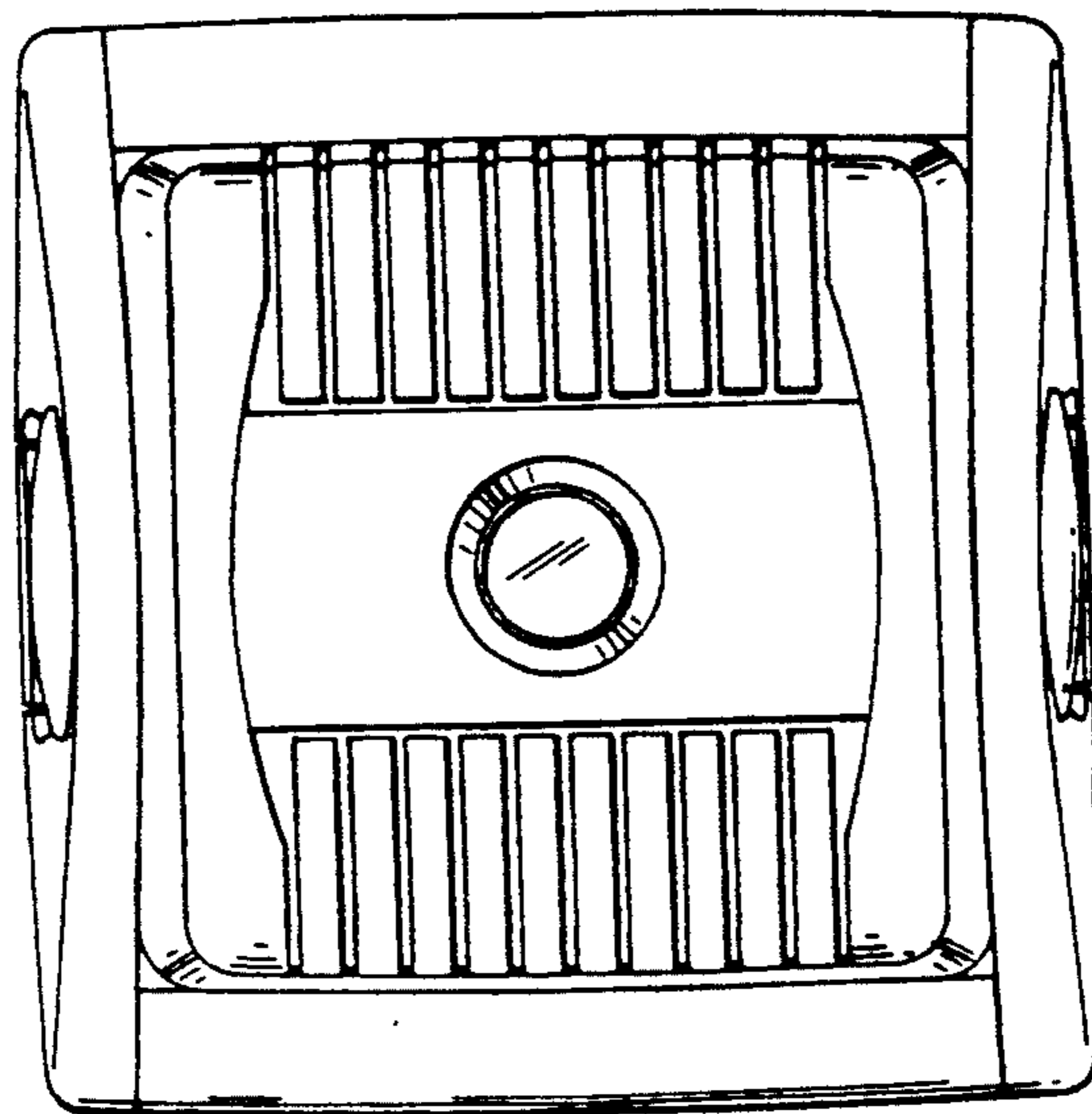

FIG. 6

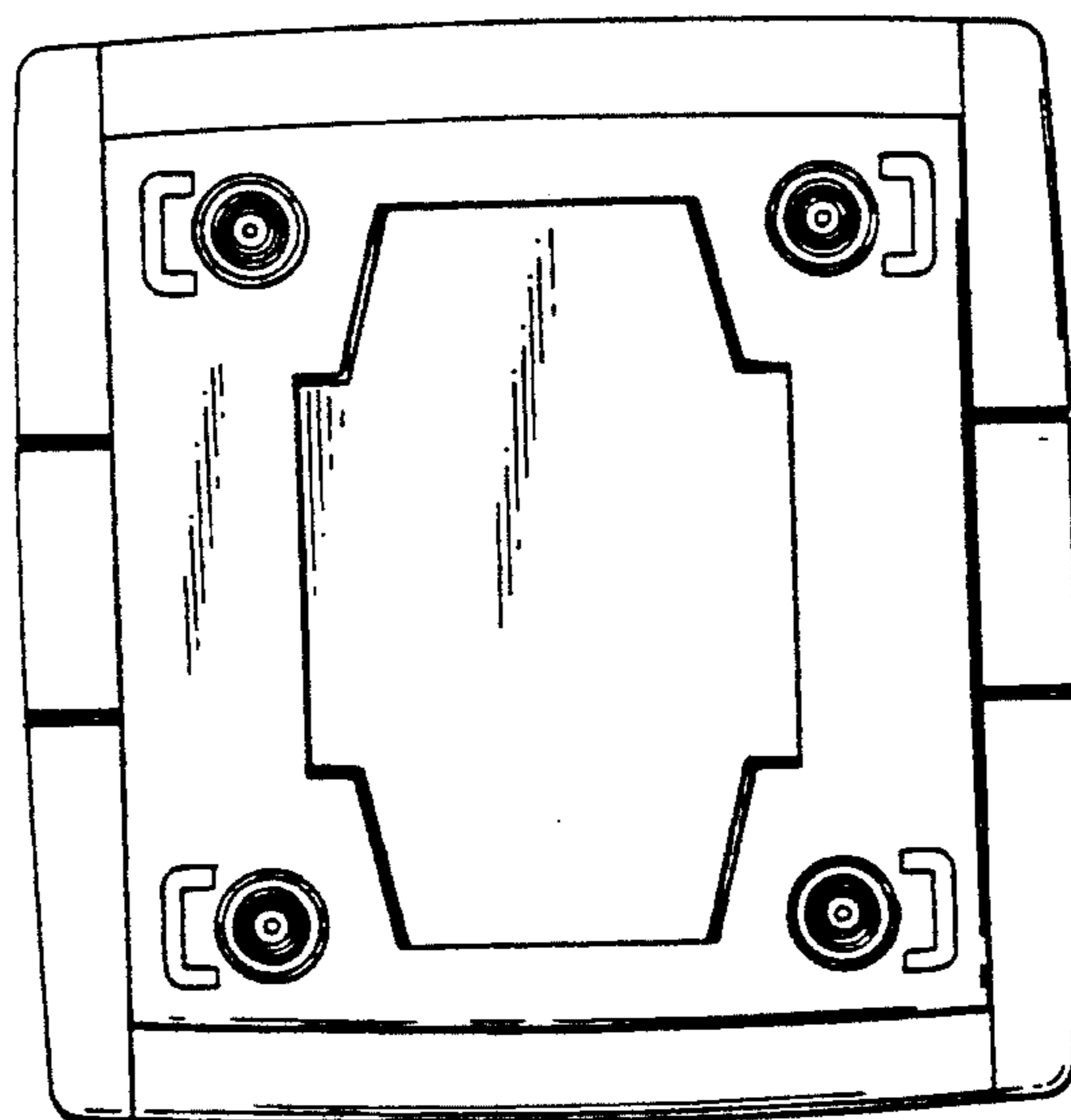

FIG. 7

