



US00D345199S

United States Patent [19]
Laughton

[11] **Patent Number: Des. 345,199**
[45] **Date of Patent: ** Mar. 15, 1994**

[54] **LAVATORY**

[75] **Inventor: John Laughton, Bedminster, N.J.**
[73] **Assignee: American Standard Inc., New York, N.Y.**
[**] **Term: 14 Years**
[21] **Appl. No.: 817,129**
[22] **Filed: Dec. 31, 1991**
[52] **U.S. Cl. D23/294**
[58] **Field of Search 4/619, 650-653, 4/660; D23/284-294**

[56] **References Cited**

U.S. PATENT DOCUMENTS

D. 319,689	9/1991	Levien	D23/294
787,202	4/1905	Mattingly	4/651
867,957	10/1907	Dorav	4/651
931,489	8/1909	Rizek	4/653
3,108,288	10/1963	Herzog	4/639

OTHER PUBLICATIONS

Borg-Warner Plumbing Products Catalog, 1975, "Cot-tey" Lavatory.

Primary Examiner—James R. Largen
Attorney, Agent, or Firm—Elaine Brenner Robinson;
Ann M. Knab

[57] **CLAIM**

The ornamental design for a lavatory, as shown and described.

DESCRIPTION

FIG. 1 is a perspective view taken from the top, front and right side of a lavatory showing my new design;
FIG. 2 is a front elevational view thereof;
FIG. 3 is a top plan view thereof;

FIG. 4 is a left side elevational view thereof;
FIG. 5 is a rear elevational view thereof;
FIG. 6 is a bottom plan view thereof;
FIG. 7 is a perspective view taken from the top, front and right side of a second embodiment thereof;
FIG. 8 is a front elevational view of FIG. 7;
FIG. 9 is a top plan view of FIG. 7;
FIG. 10 is a left side elevational view of FIG. 7;
FIG. 11 is a rear elevational view of FIG. 7;
FIG. 12 is a bottom plan view of FIG. 7;
FIG. 13 is a perspective view taken from the top, front and right side of a third embodiment thereof;
FIG. 14 is a front elevational view of FIG. 13;
FIG. 15 is a top plan view of FIG. 13;
FIG. 16 is a left side elevational view of FIG. 13;
FIG. 17 is a rear elevational view of FIG. 13;
FIG. 18 is a bottom plan view of FIG. 13;
FIG. 19 is a perspective view taken from the top, front and right side of a fourth embodiment thereof;
FIG. 20 is a front elevational view of FIG. 19;
FIG. 21 is a top plan view of FIG. 19;
FIG. 22 is a left side elevational view of FIG. 19;
FIG. 23 is a rear elevational view of FIG. 19;
FIG. 24 is a bottom plan view of FIG. 19;
FIG. 25 is a perspective view taken from the top, front and right side of the fifth embodiment thereof;
FIG. 26 is a front elevational view of FIG. 25;
FIG. 27 is a top plan view of FIG. 25;
FIG. 28 is a left side elevational view of FIG. 25;
FIG. 29 is a rear elevational view of FIG. 25;
FIG. 30 is a bottom plan view of FIG. 25;
FIG. 31 is a perspective view taken from the top, front and right side of the sixth embodiment thereof;
FIG. 32 is a front elevational view of FIG. 31;
FIG. 33 is a top plan view of FIG. 31;
FIG. 34 is a left side elevational view of FIG. 31;
FIG. 35 is a rear elevational view of FIG. 31; and,
FIG. 36 is a bottom plan view of FIG. 31.

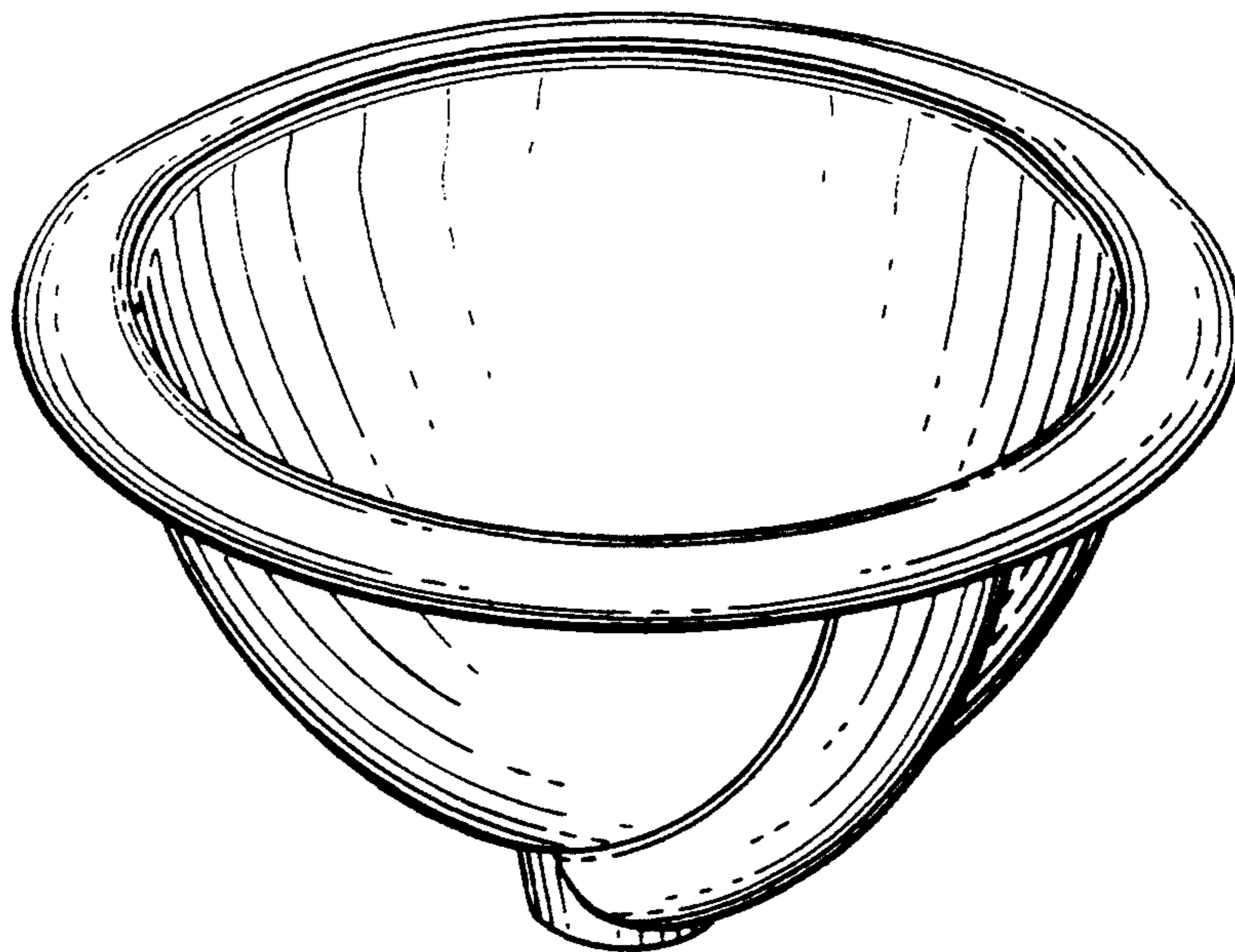

FIG. 1

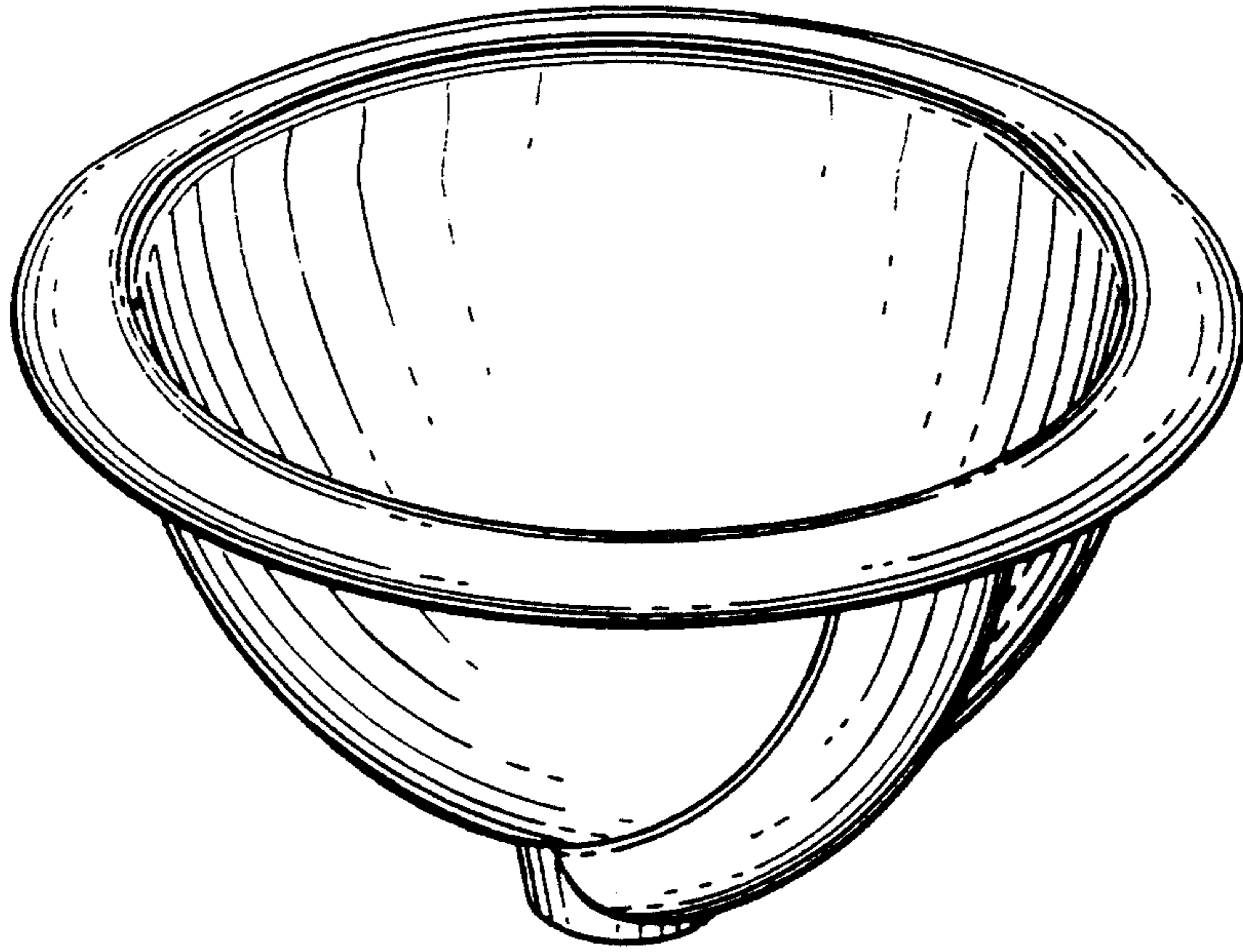

FIG. 2

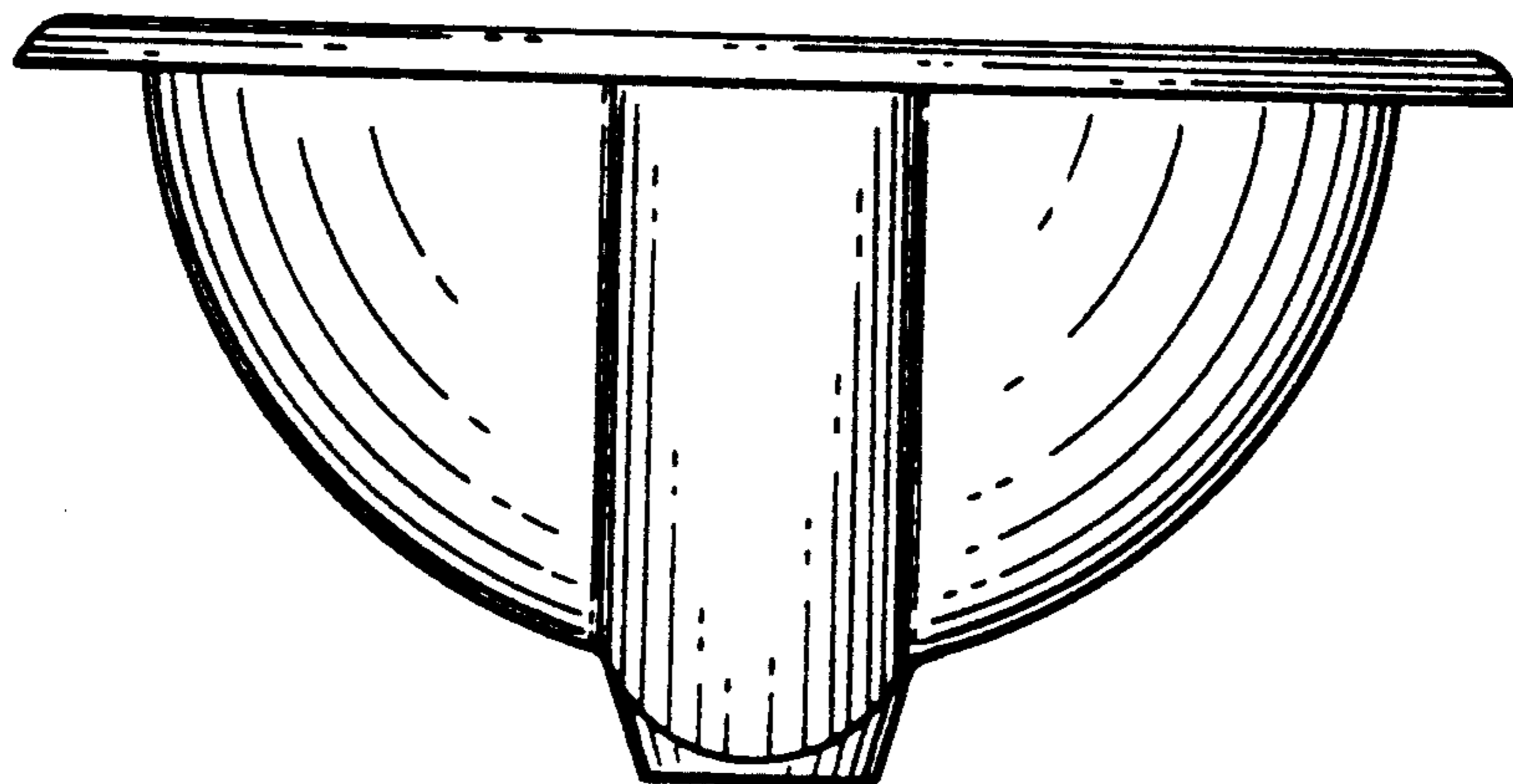

FIG. 3

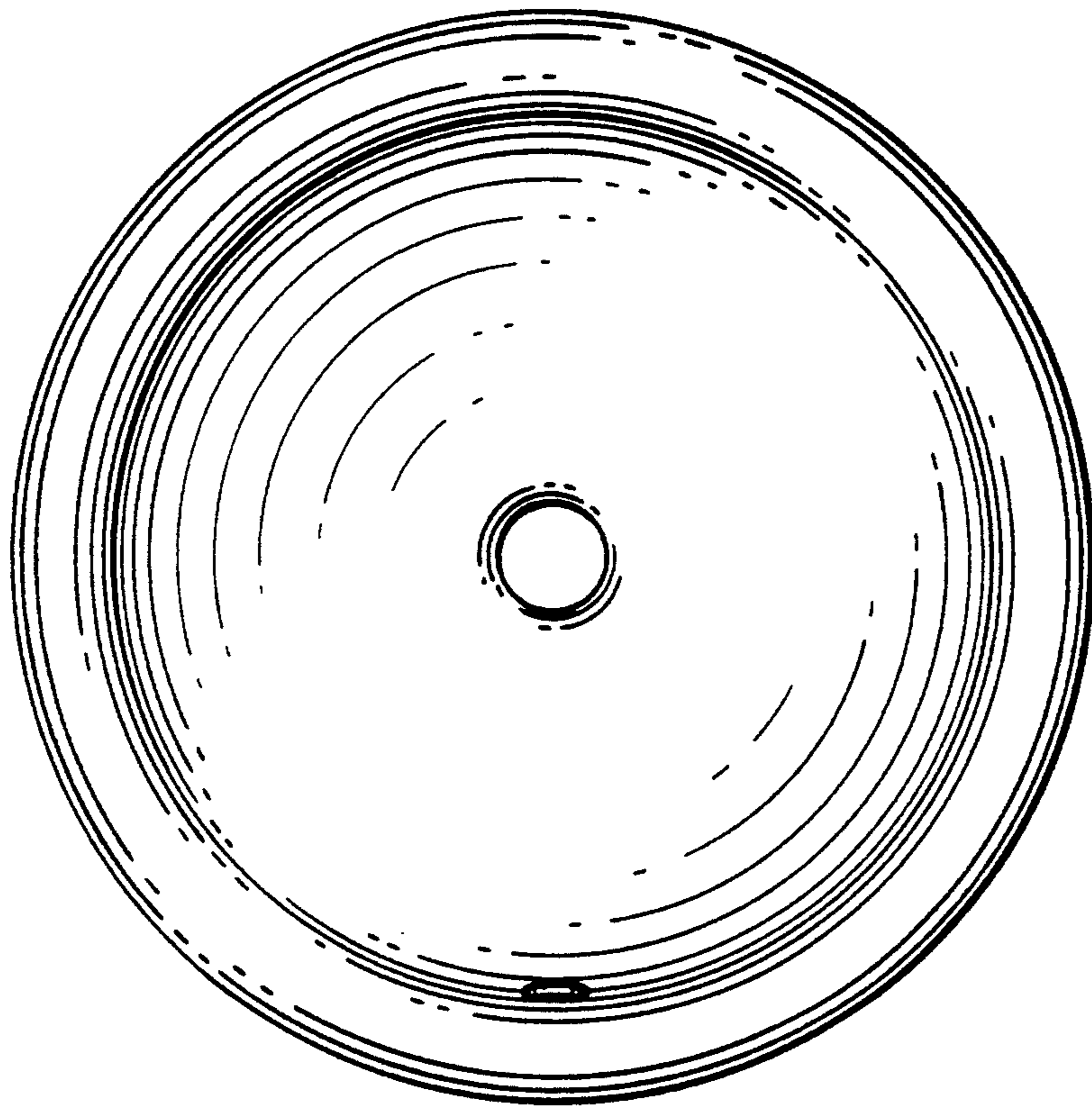

FIG. 4

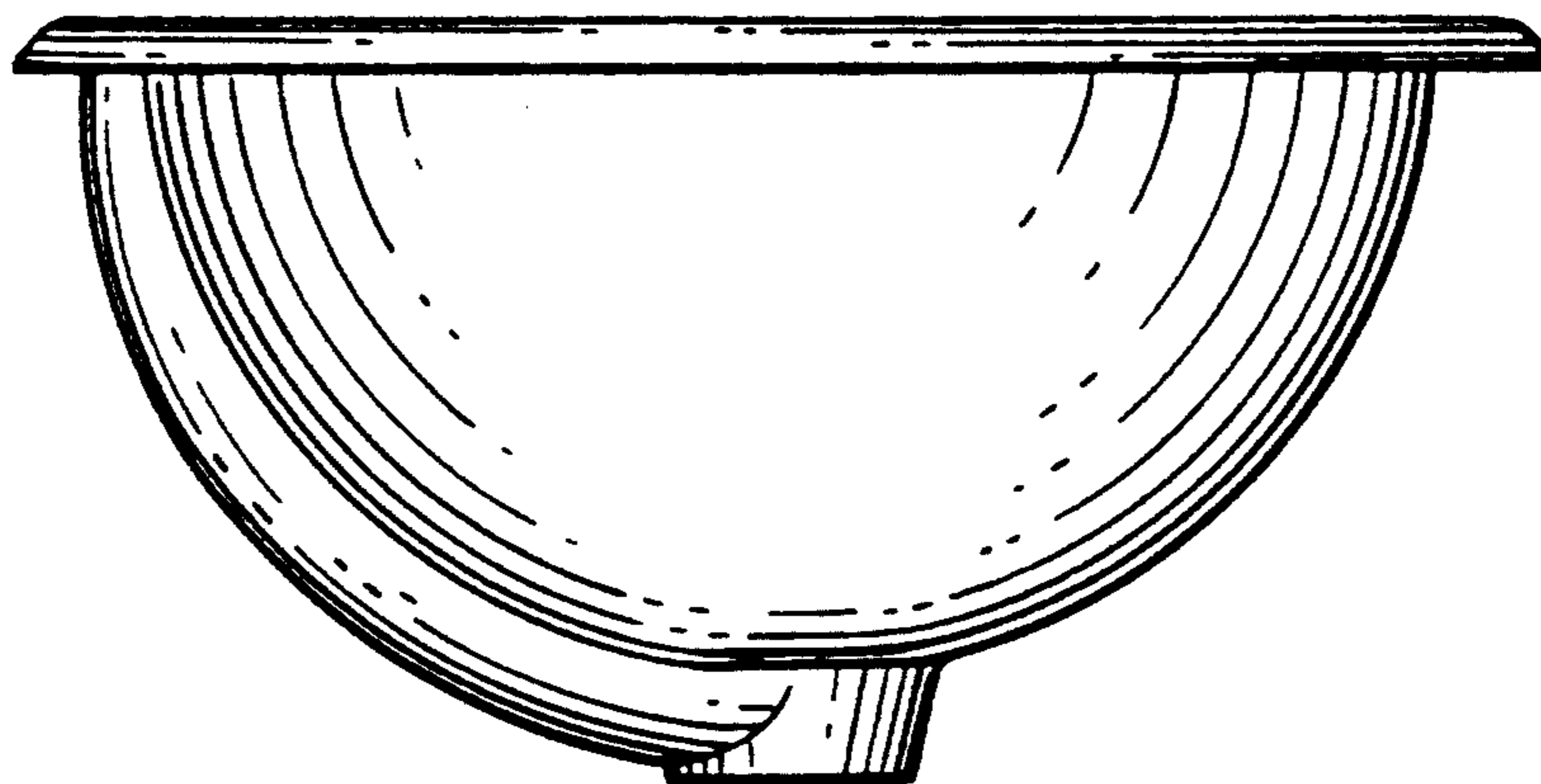

FIG. 5

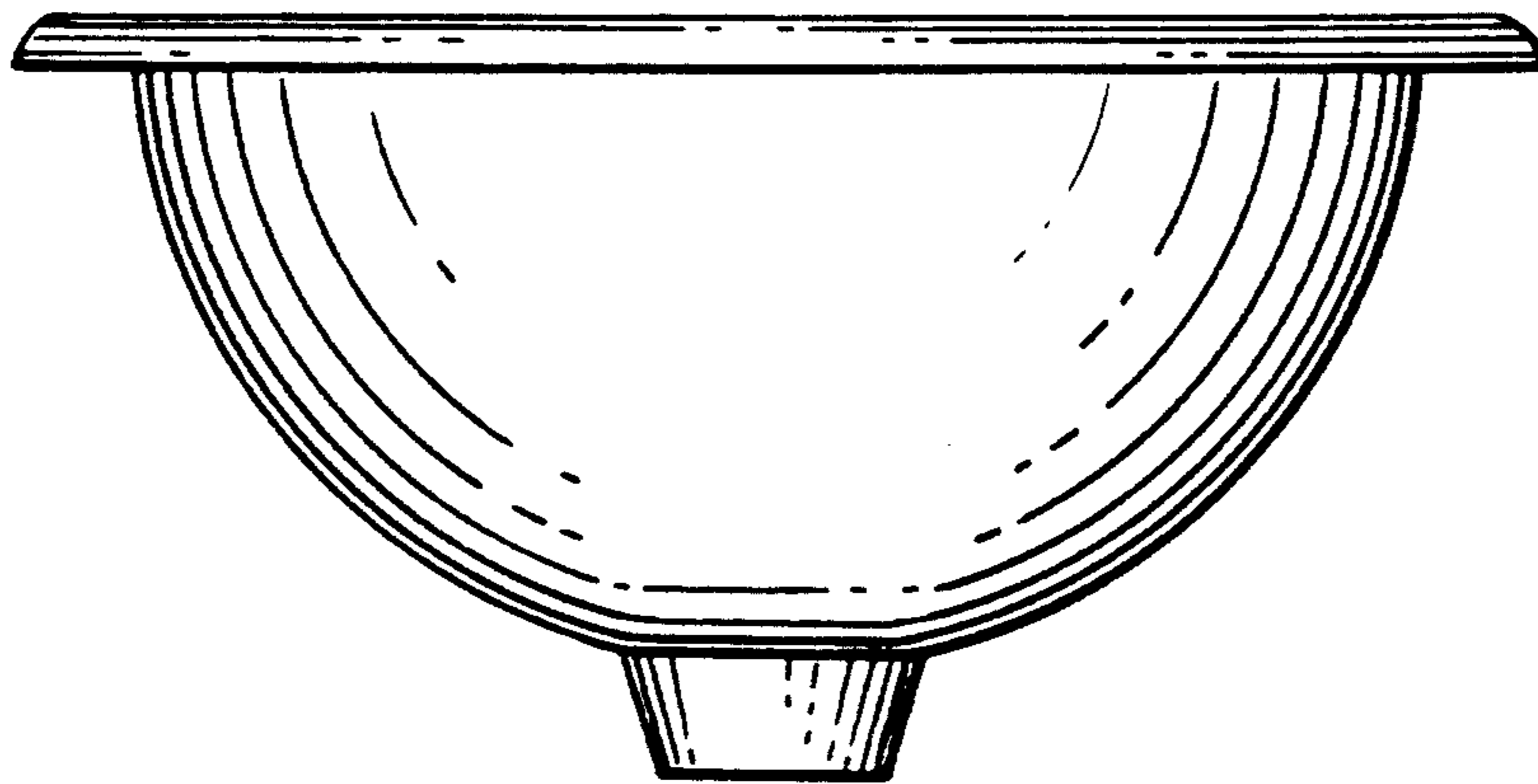

FIG. 6

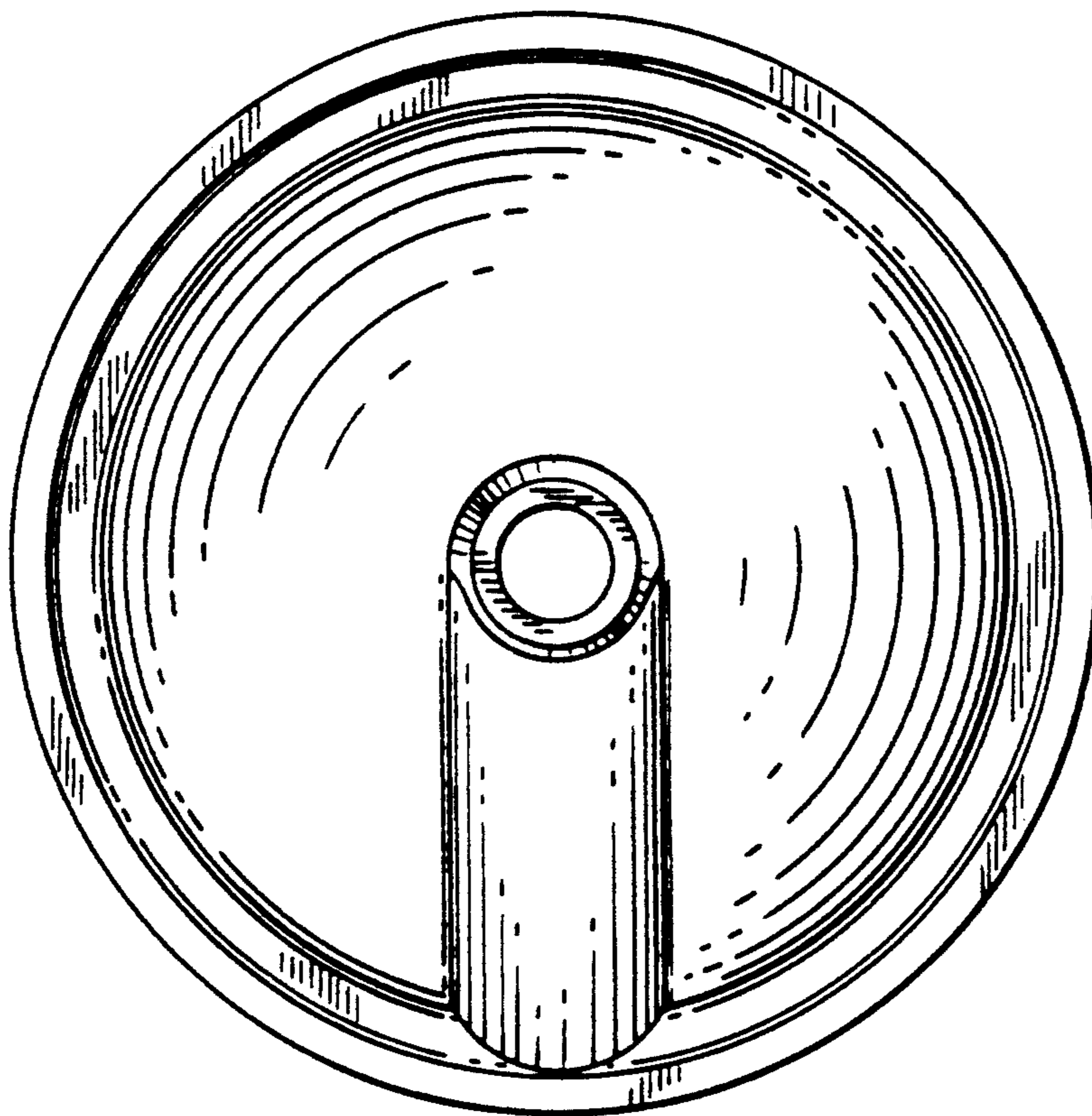

FIG. 7

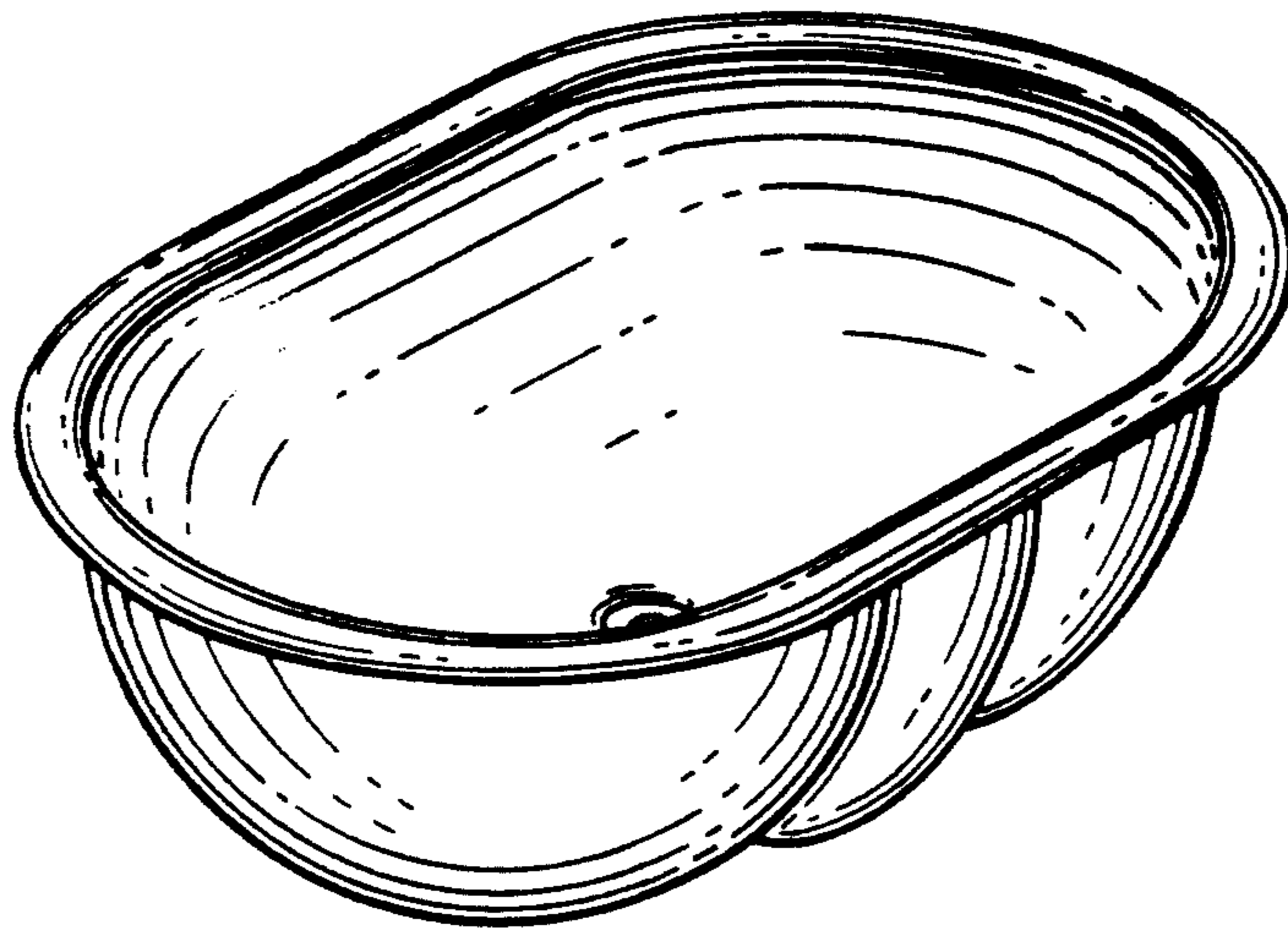

FIG. 8

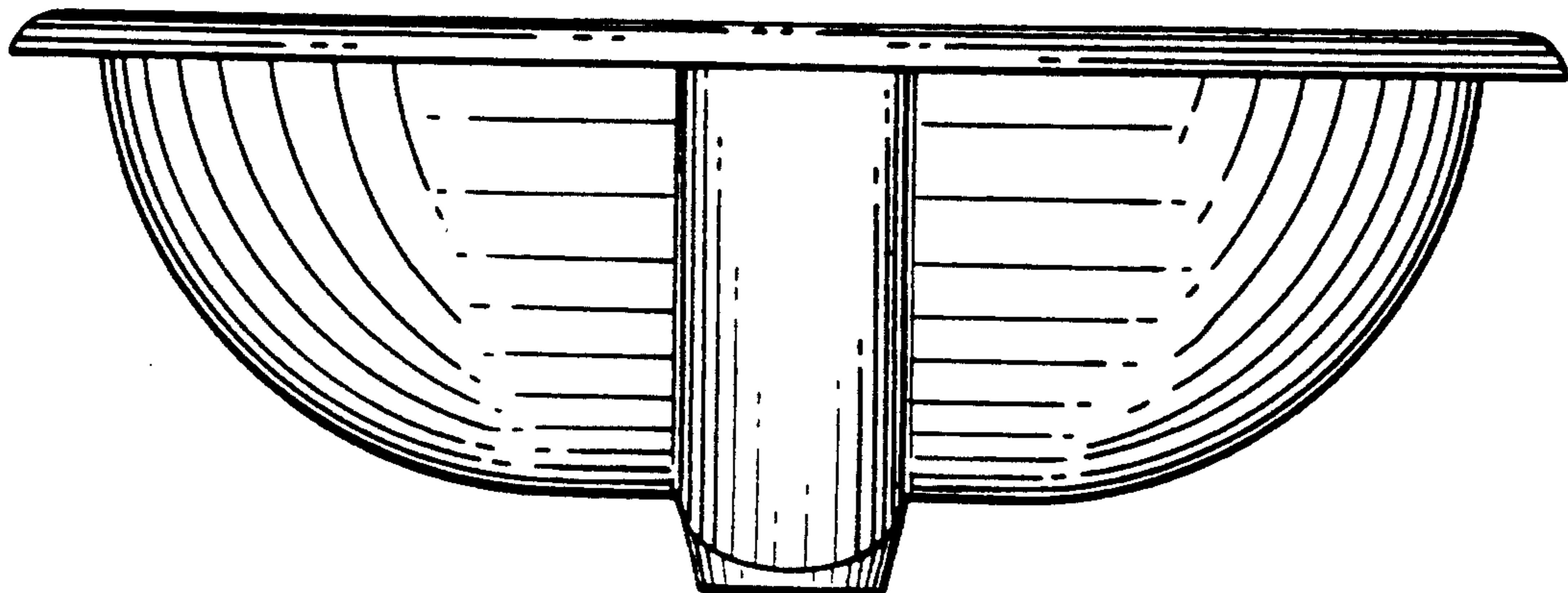

FIG. 9

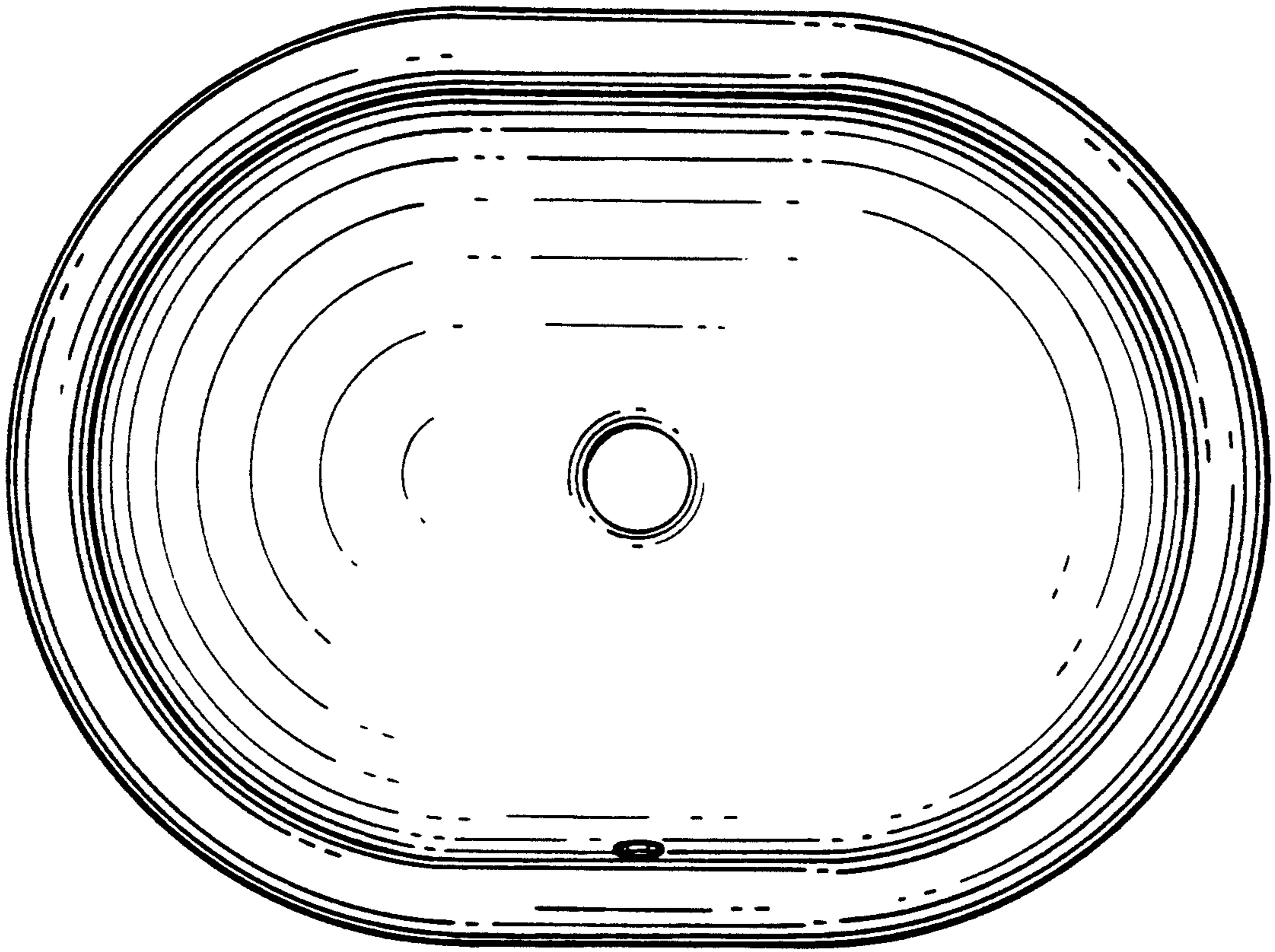

FIG. 10

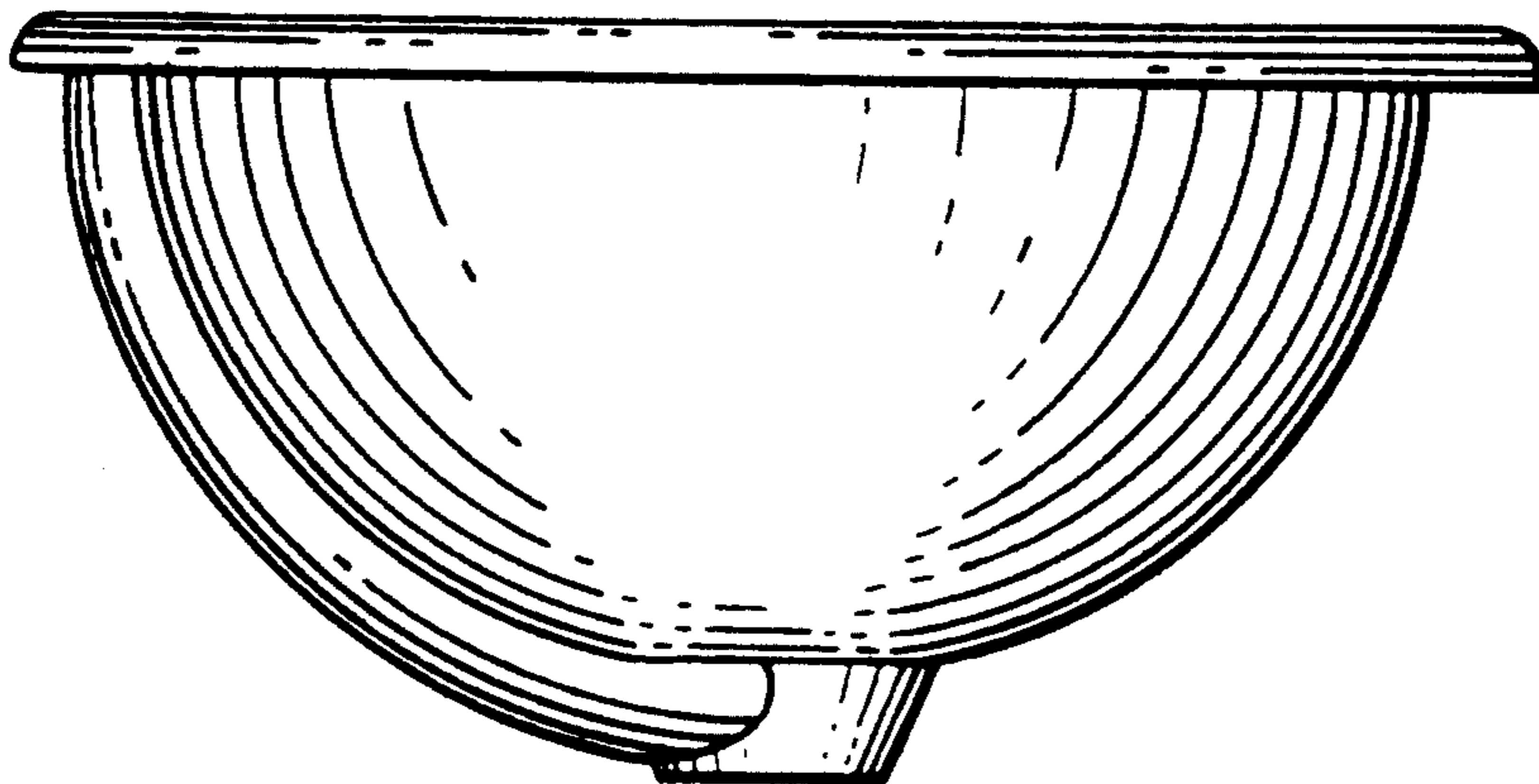

FIG. 11

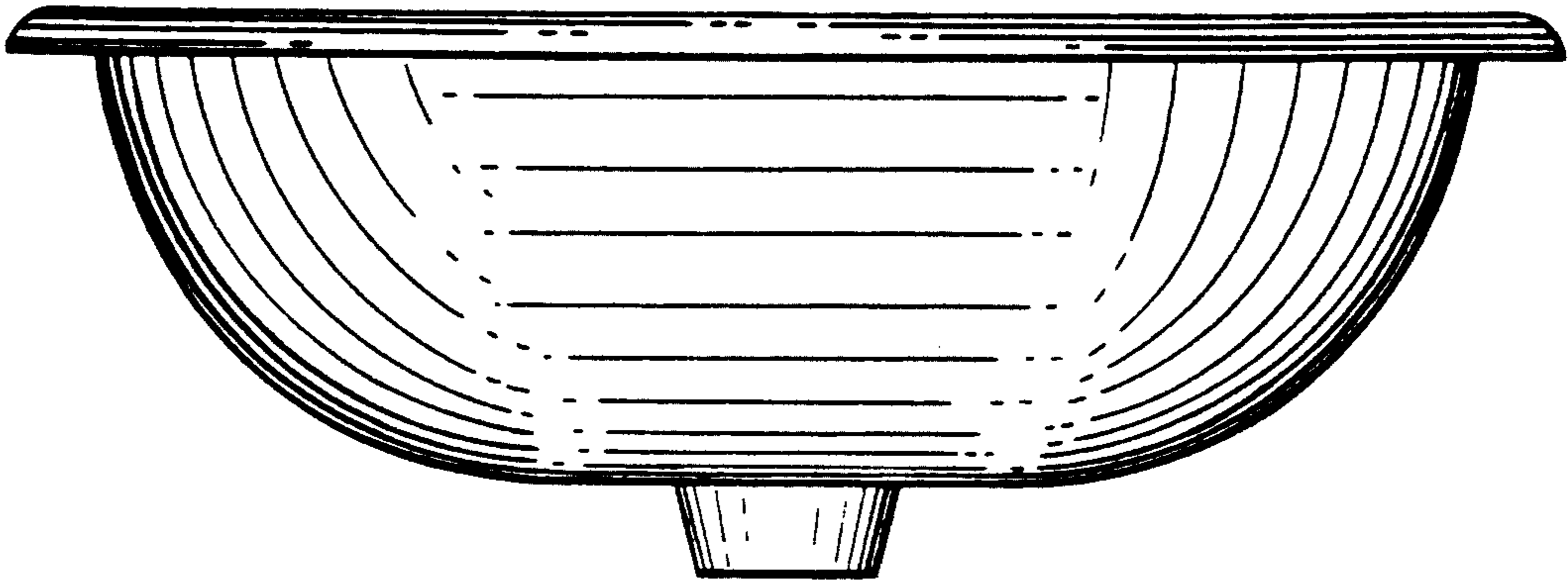

FIG. 12

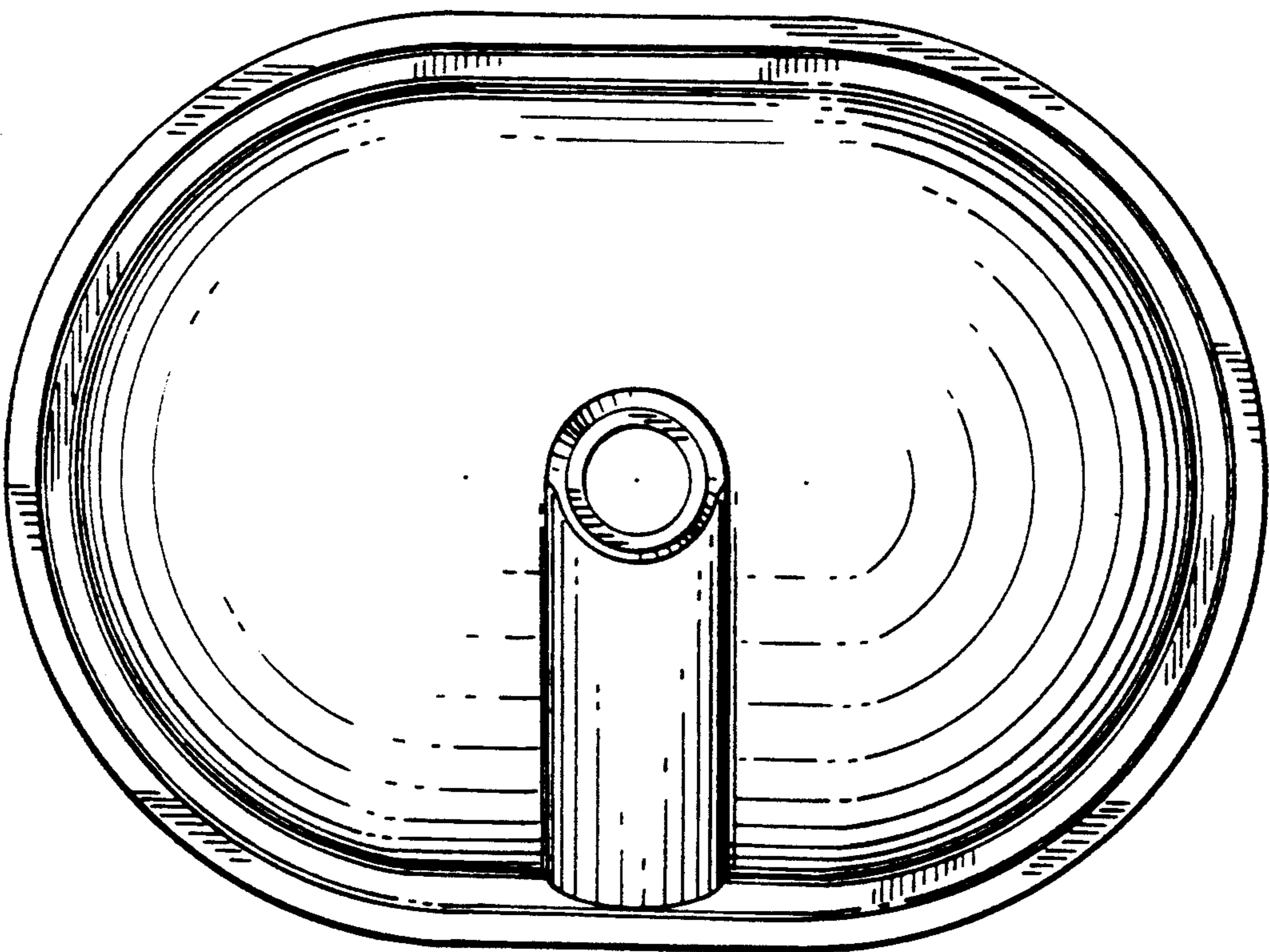

FIG. 13

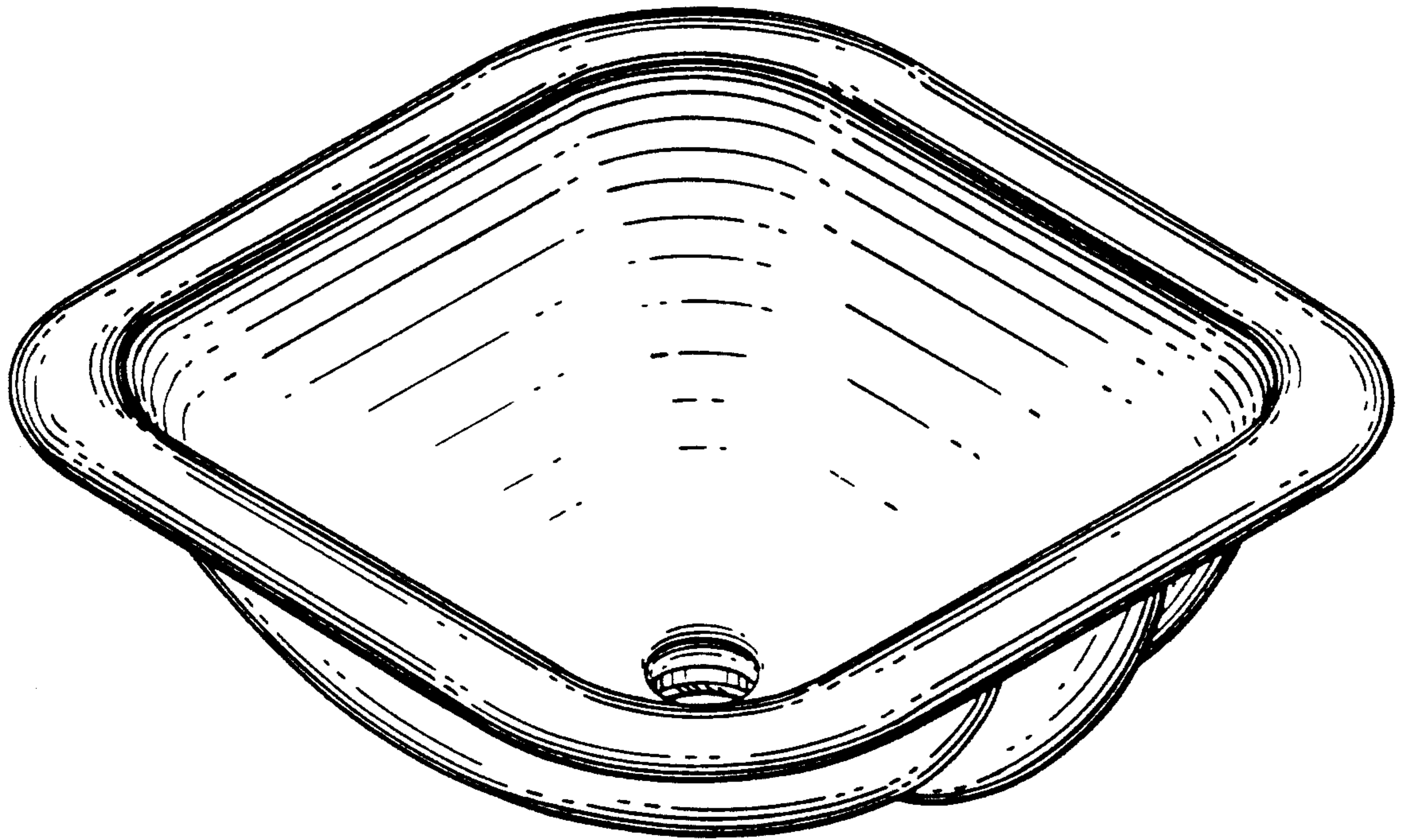

FIG. 14

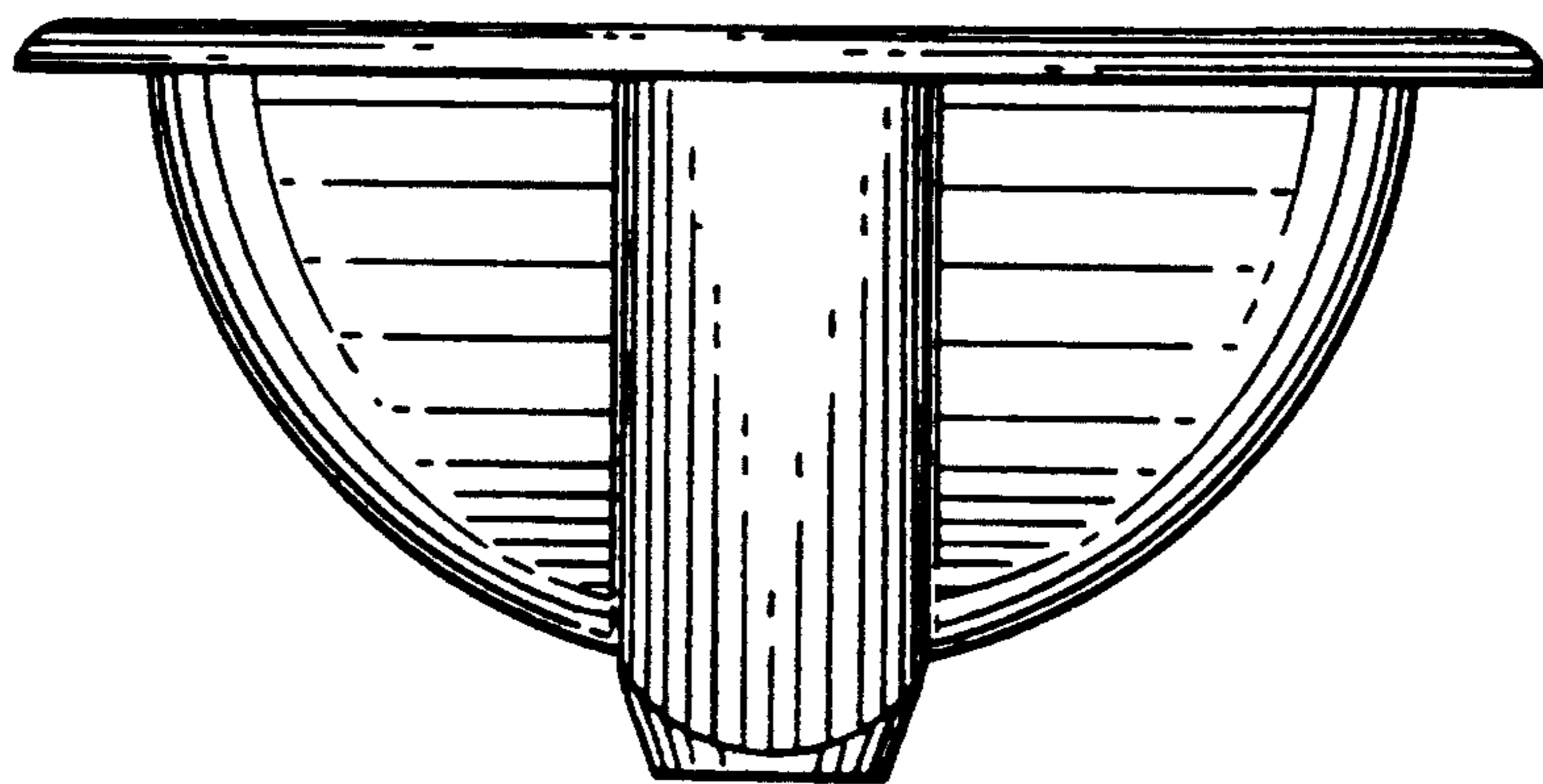

FIG. 15

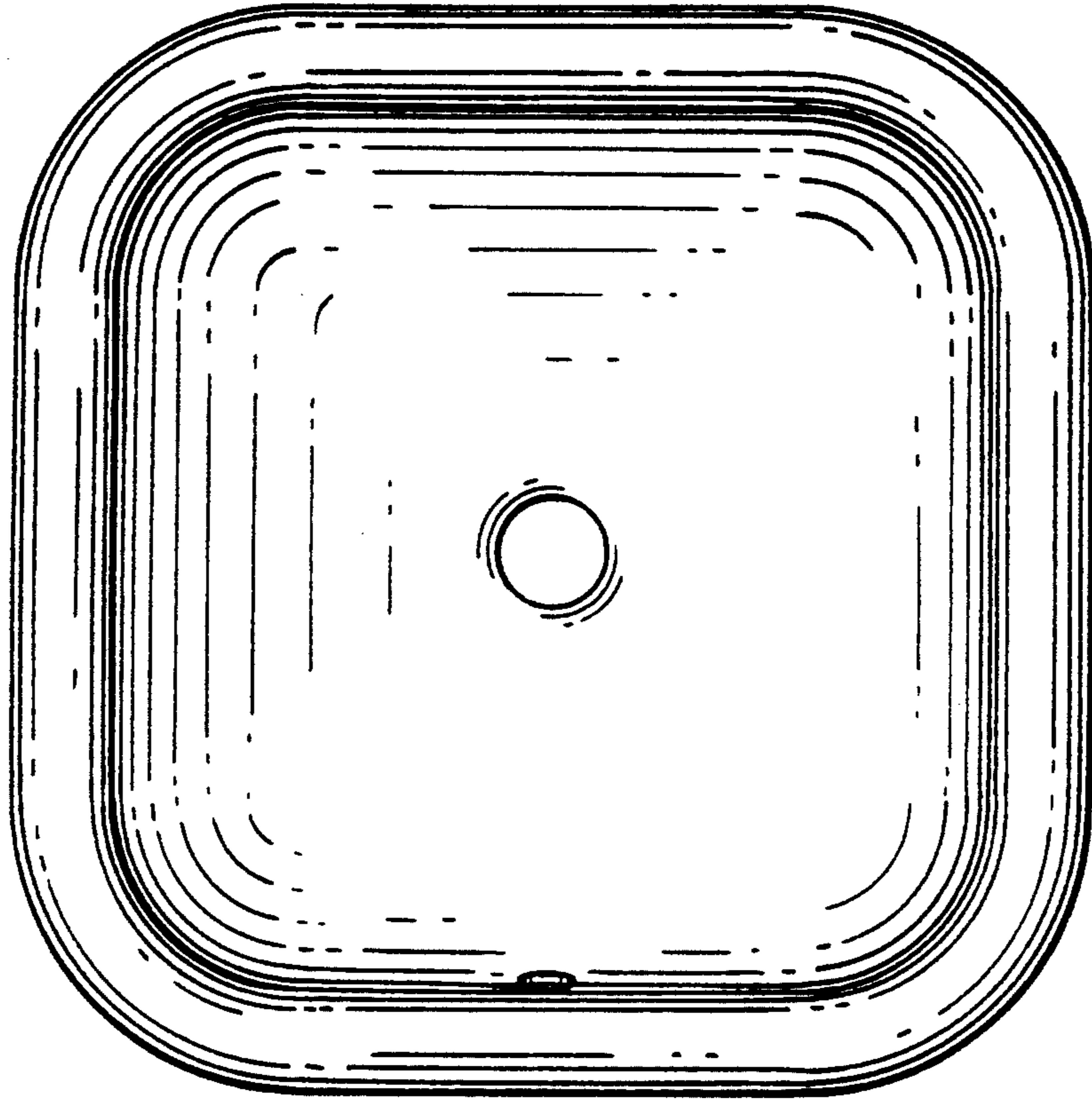

FIG. 16

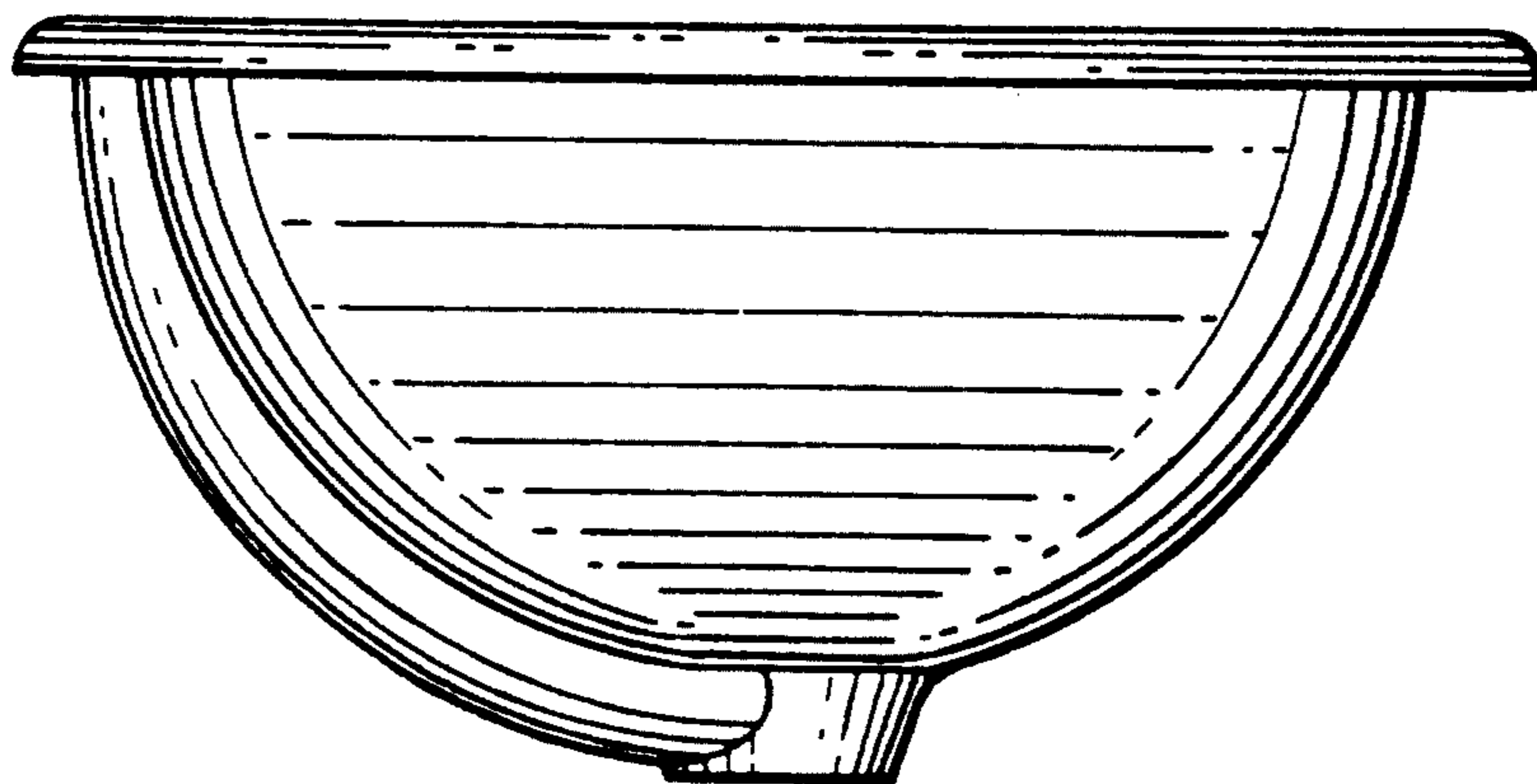

FIG. 17

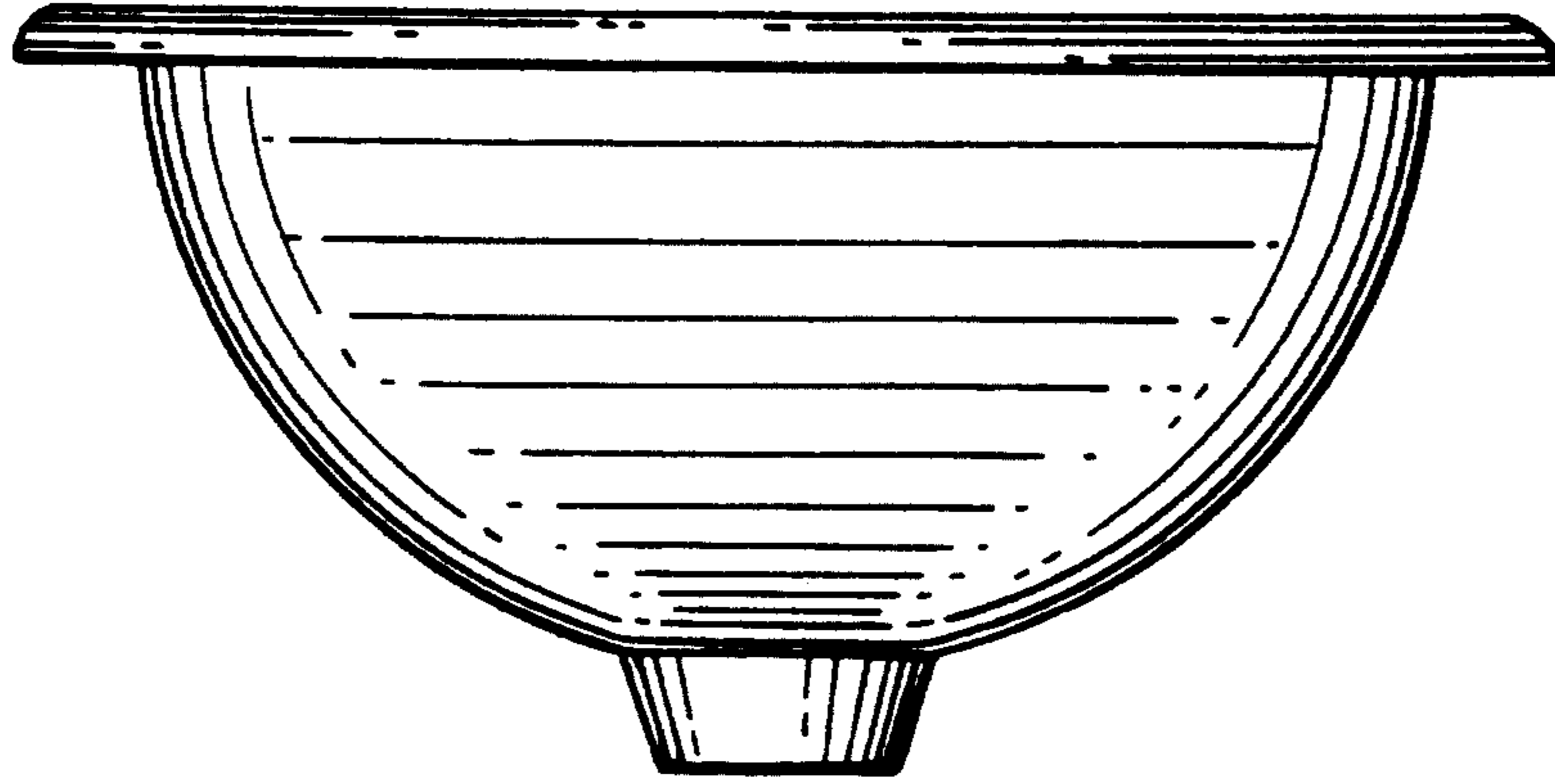

FIG. 18

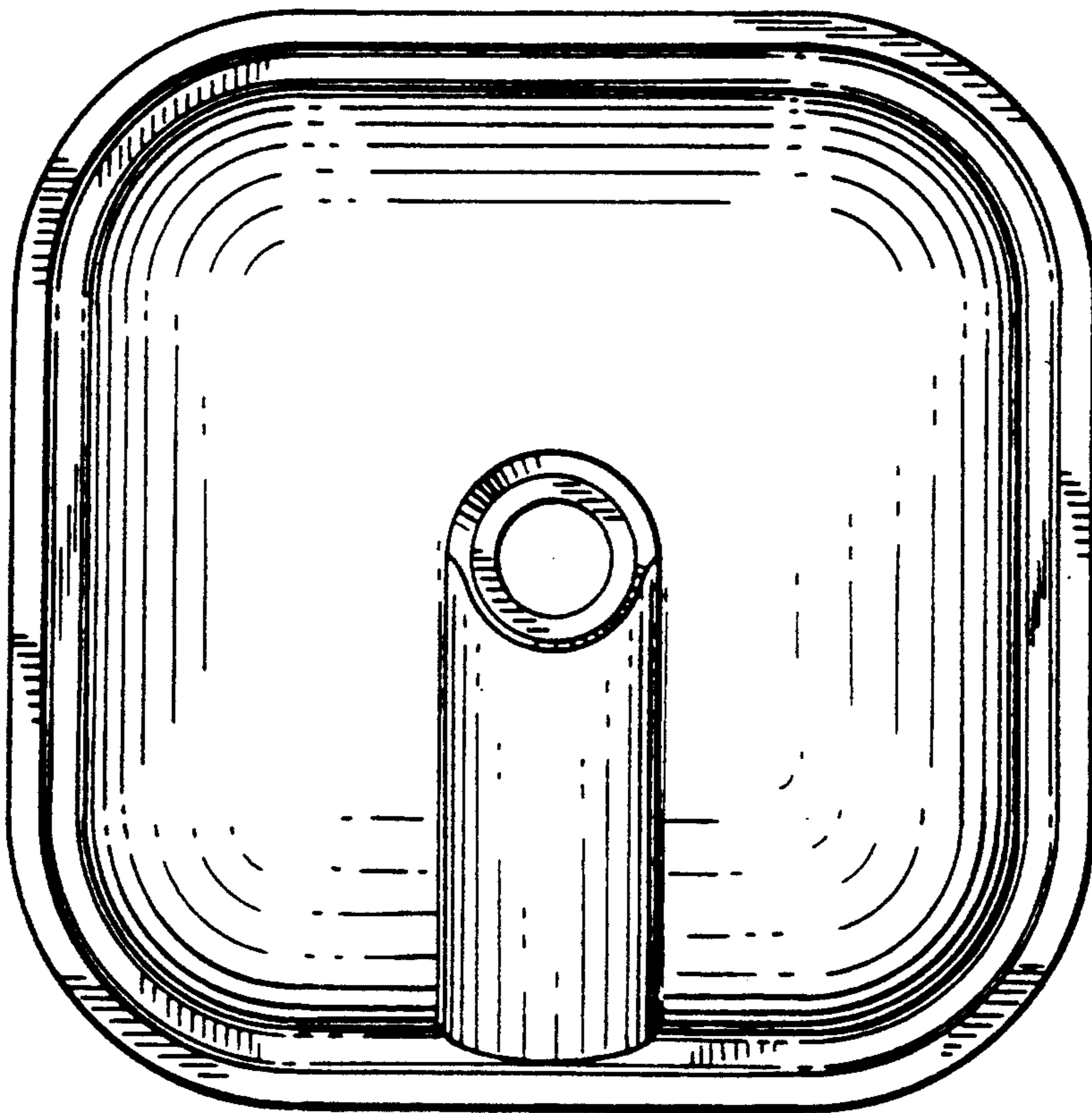

FIG. 19

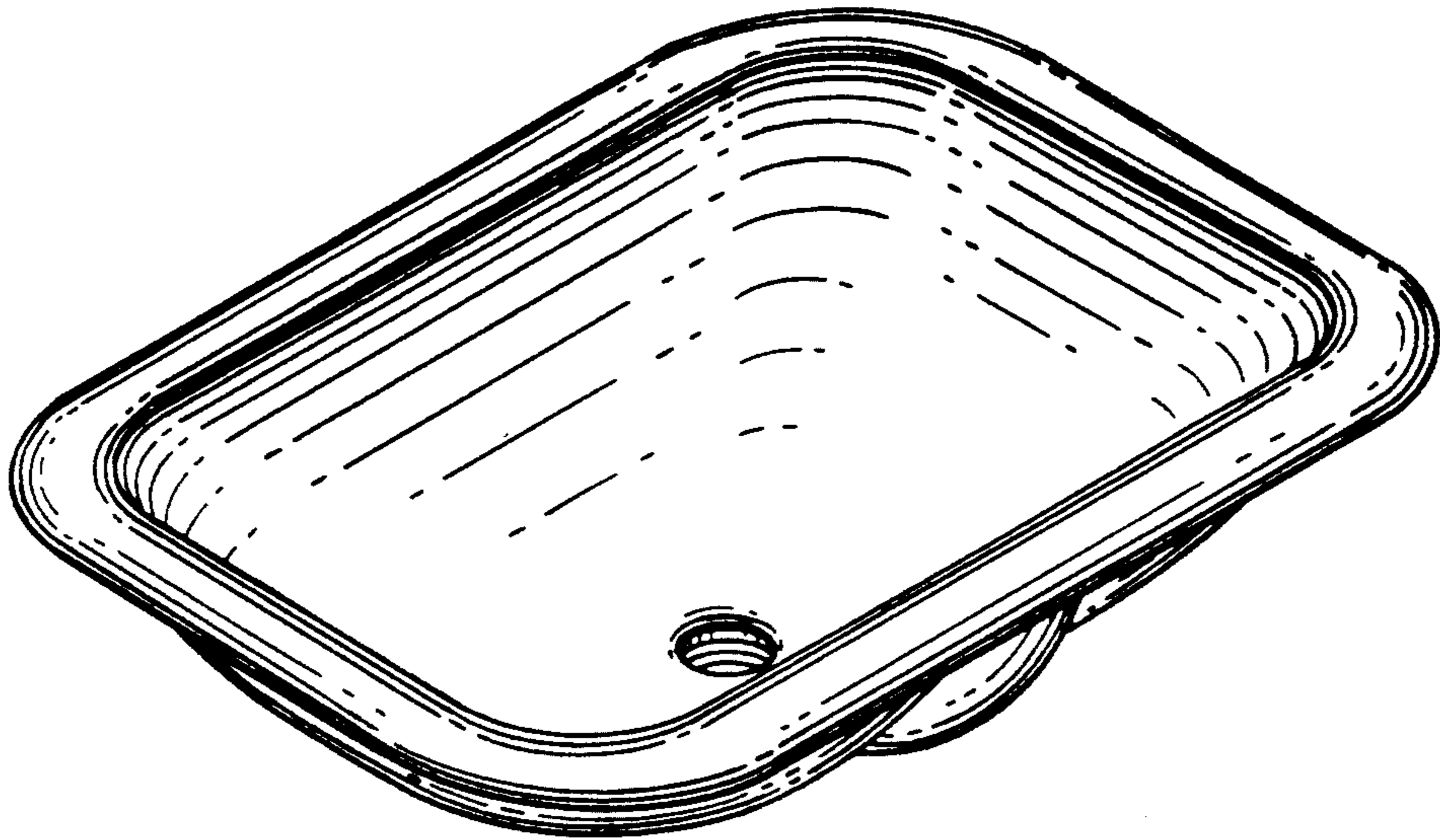

FIG. 20

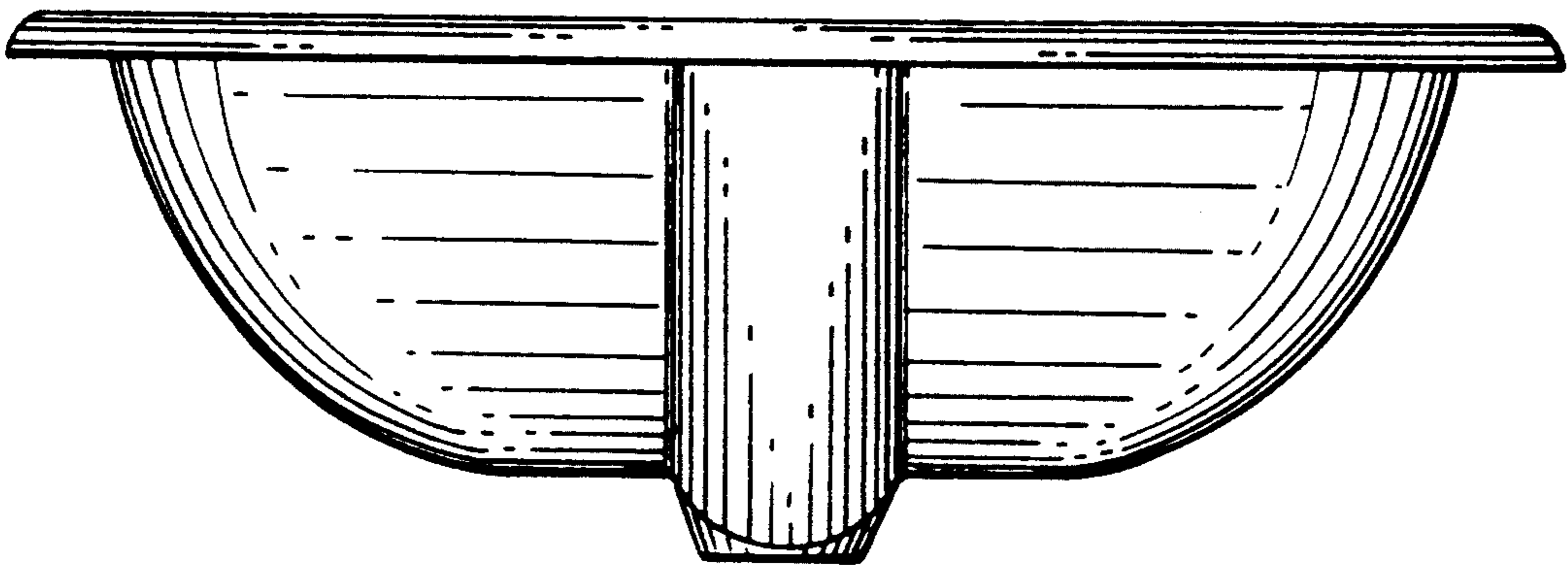

FIG. 21

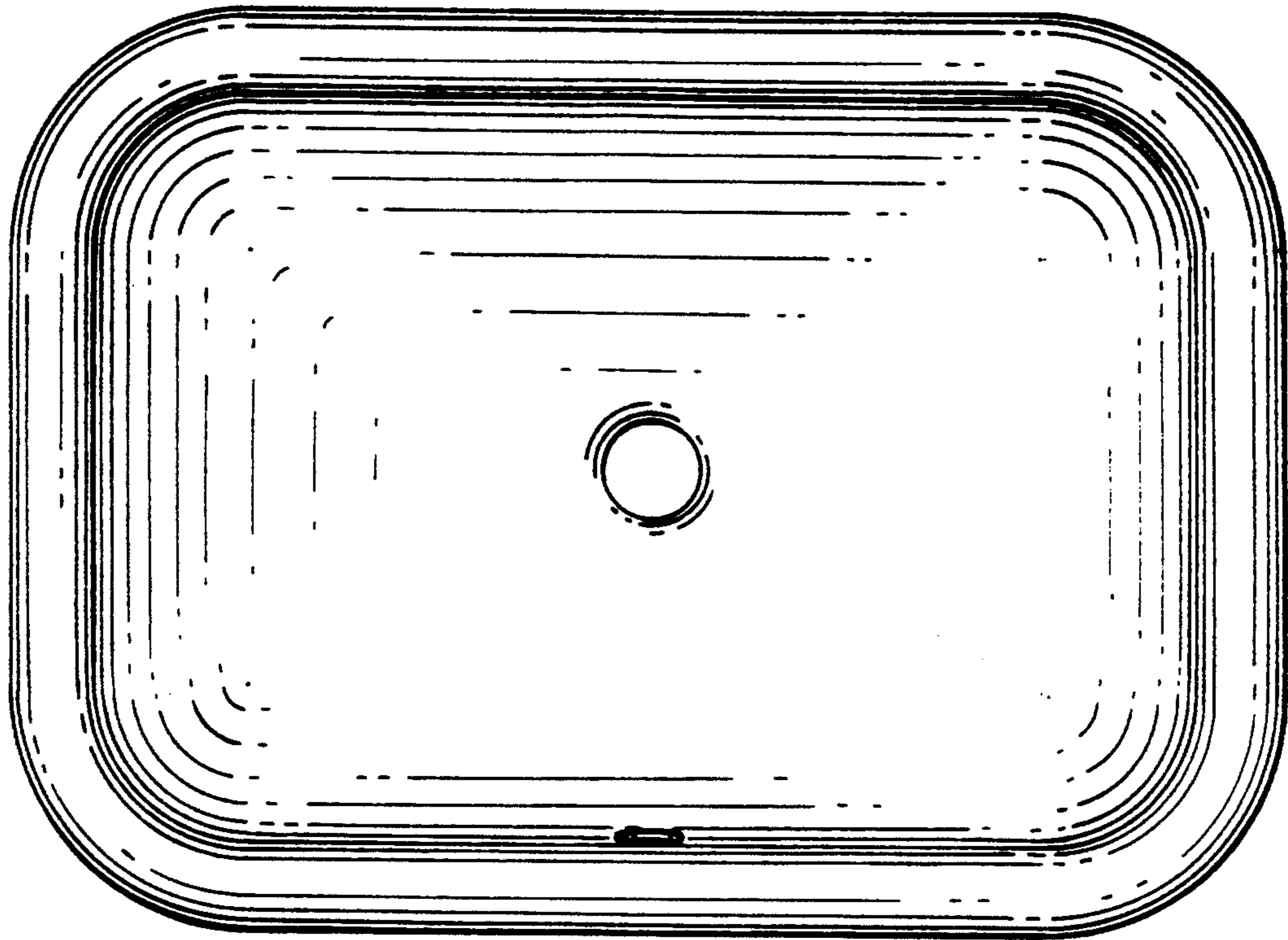

FIG. 22

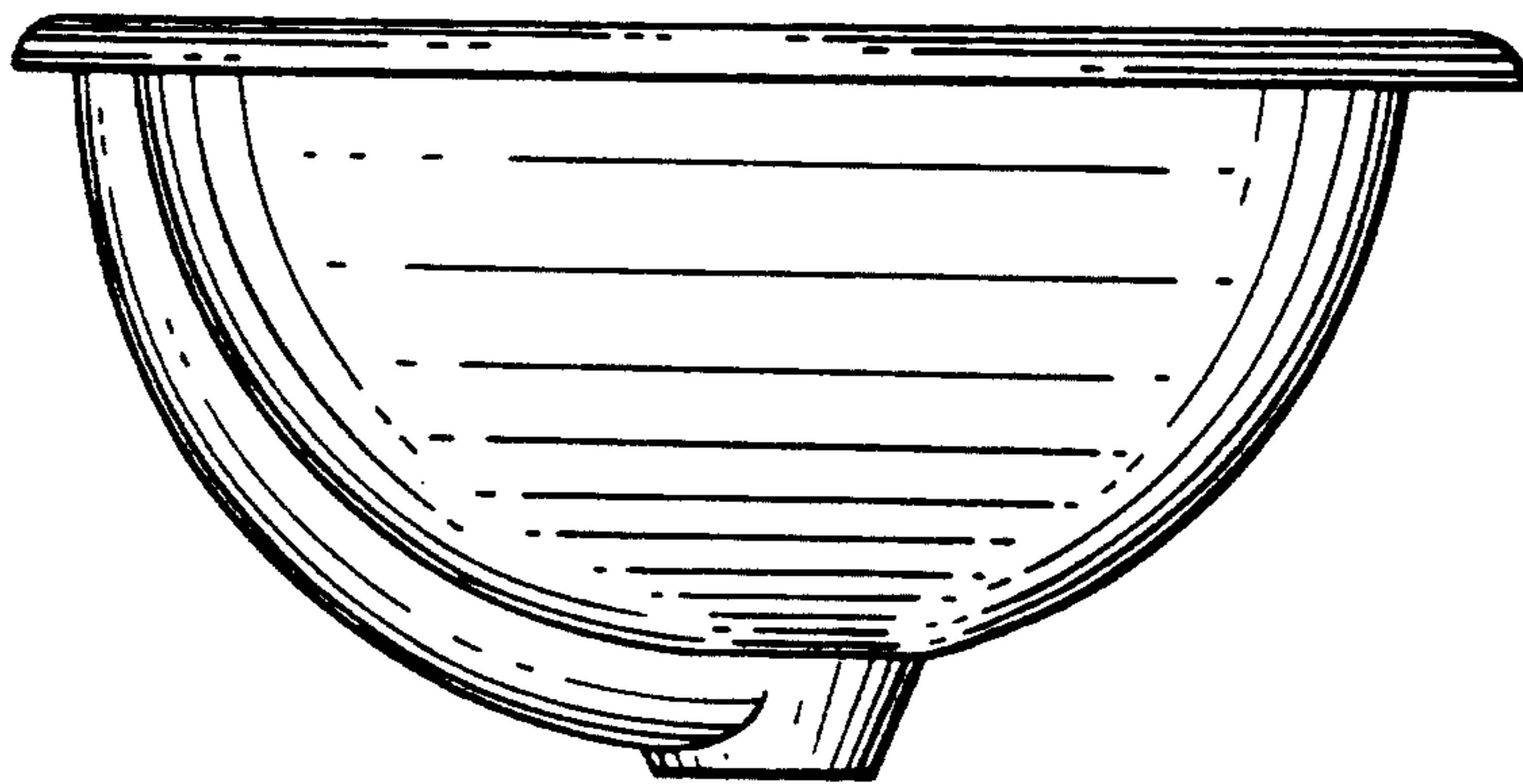

FIG. 23

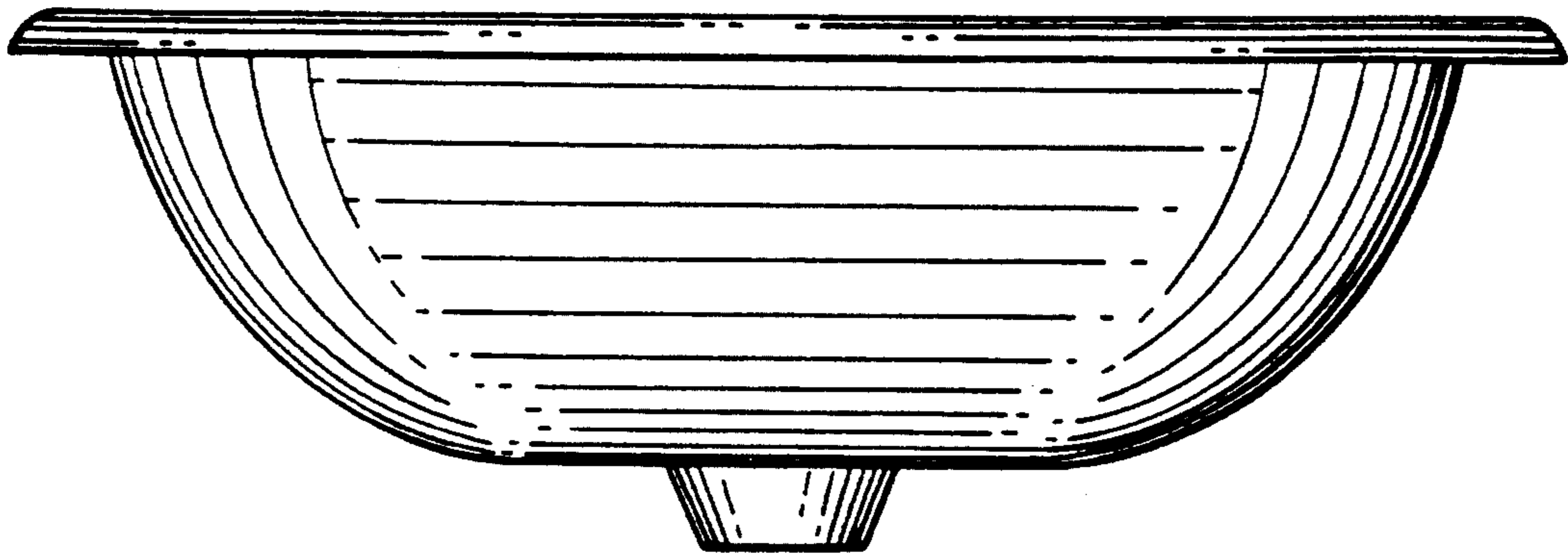

FIG. 24

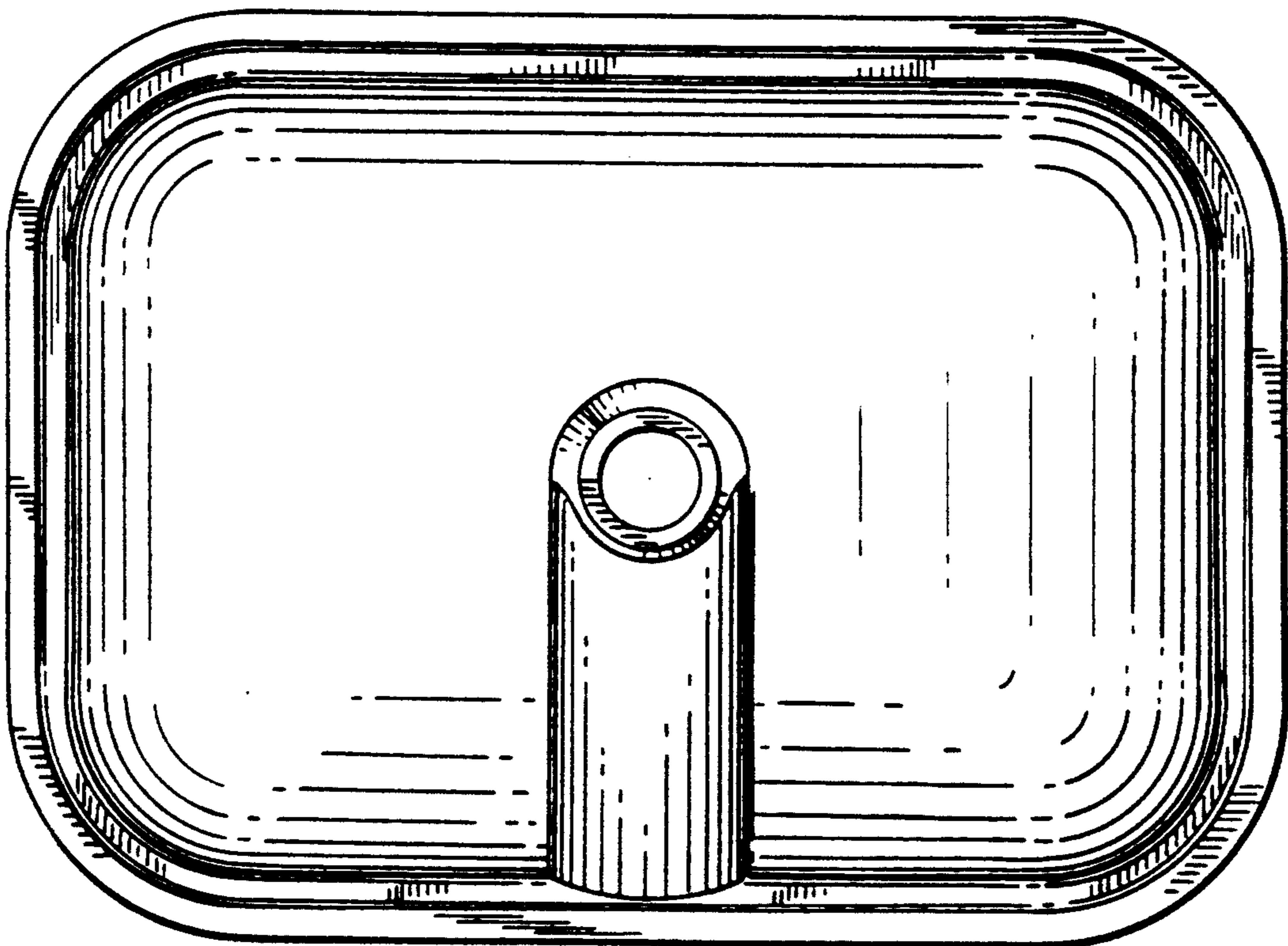

FIG. 25

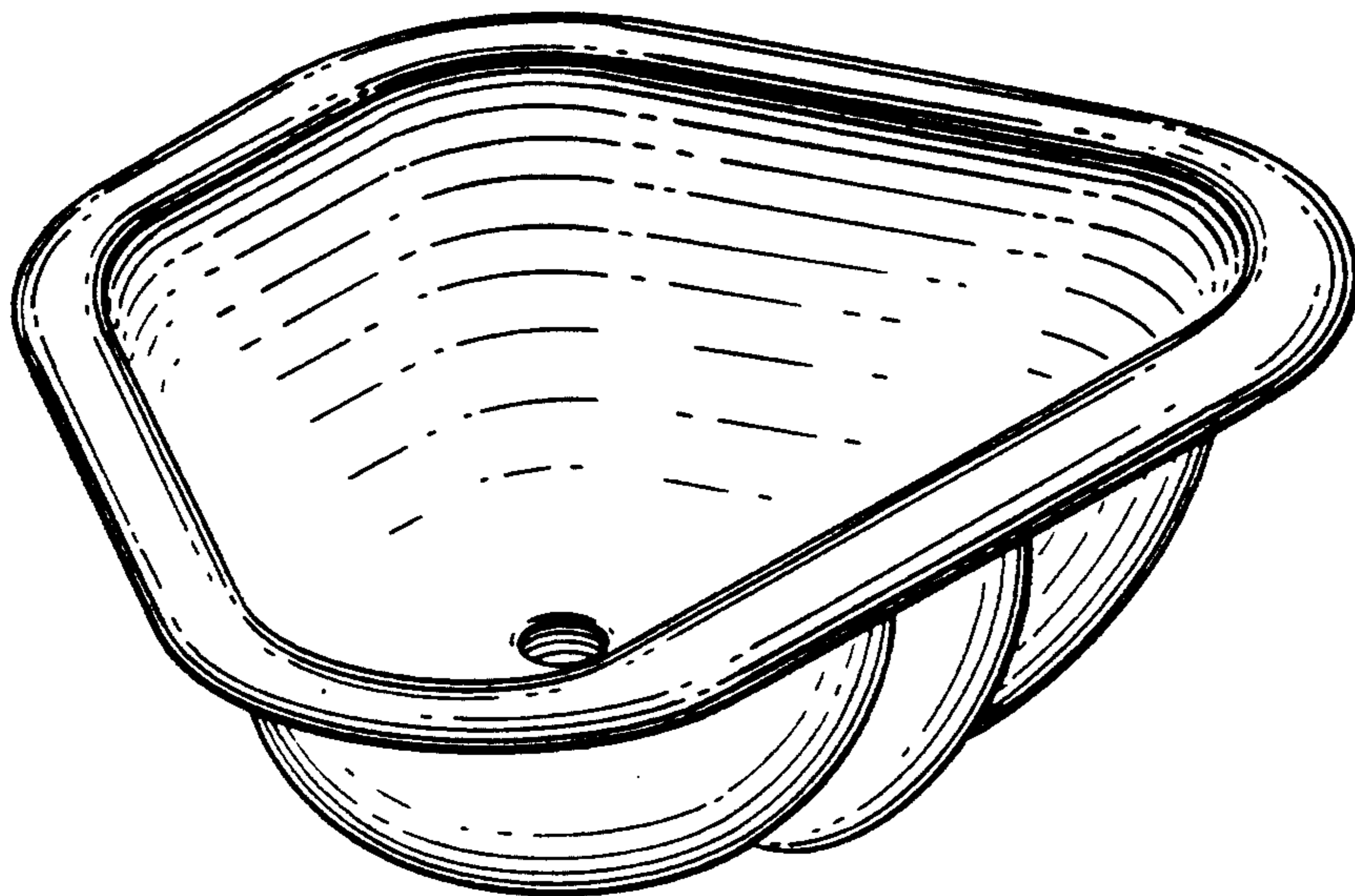
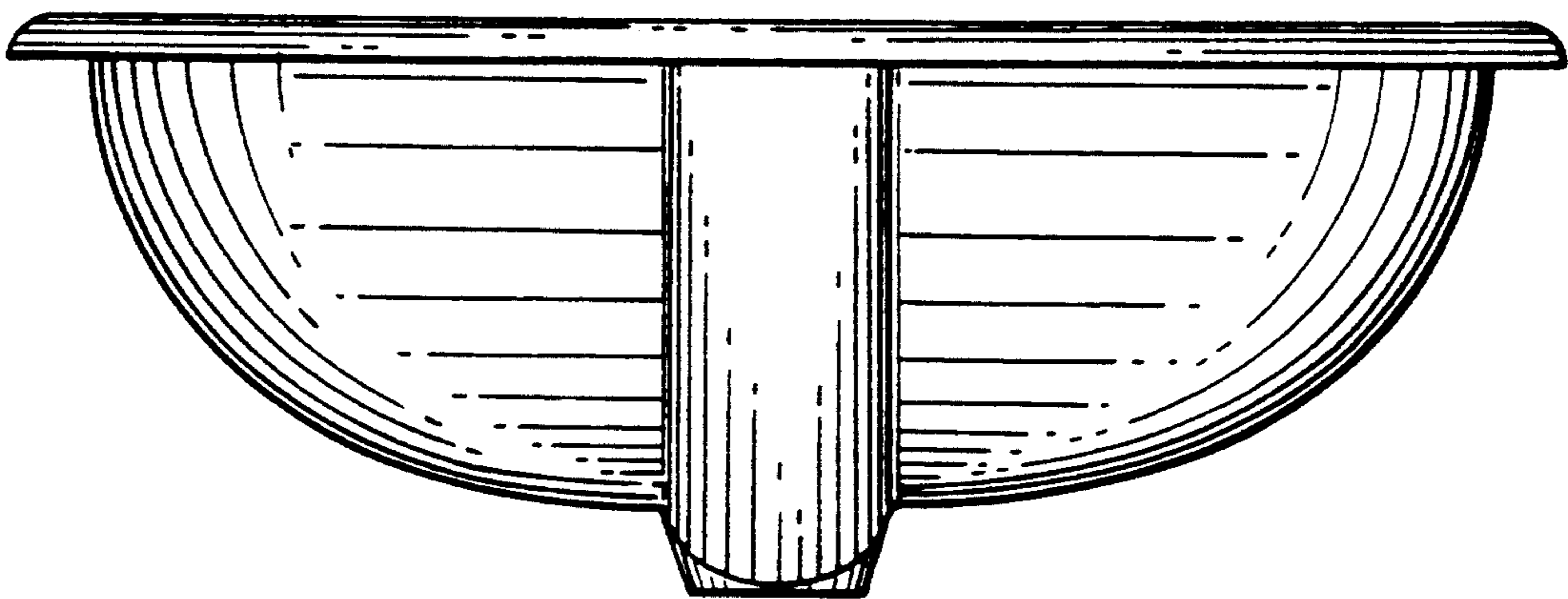

FIG. 26



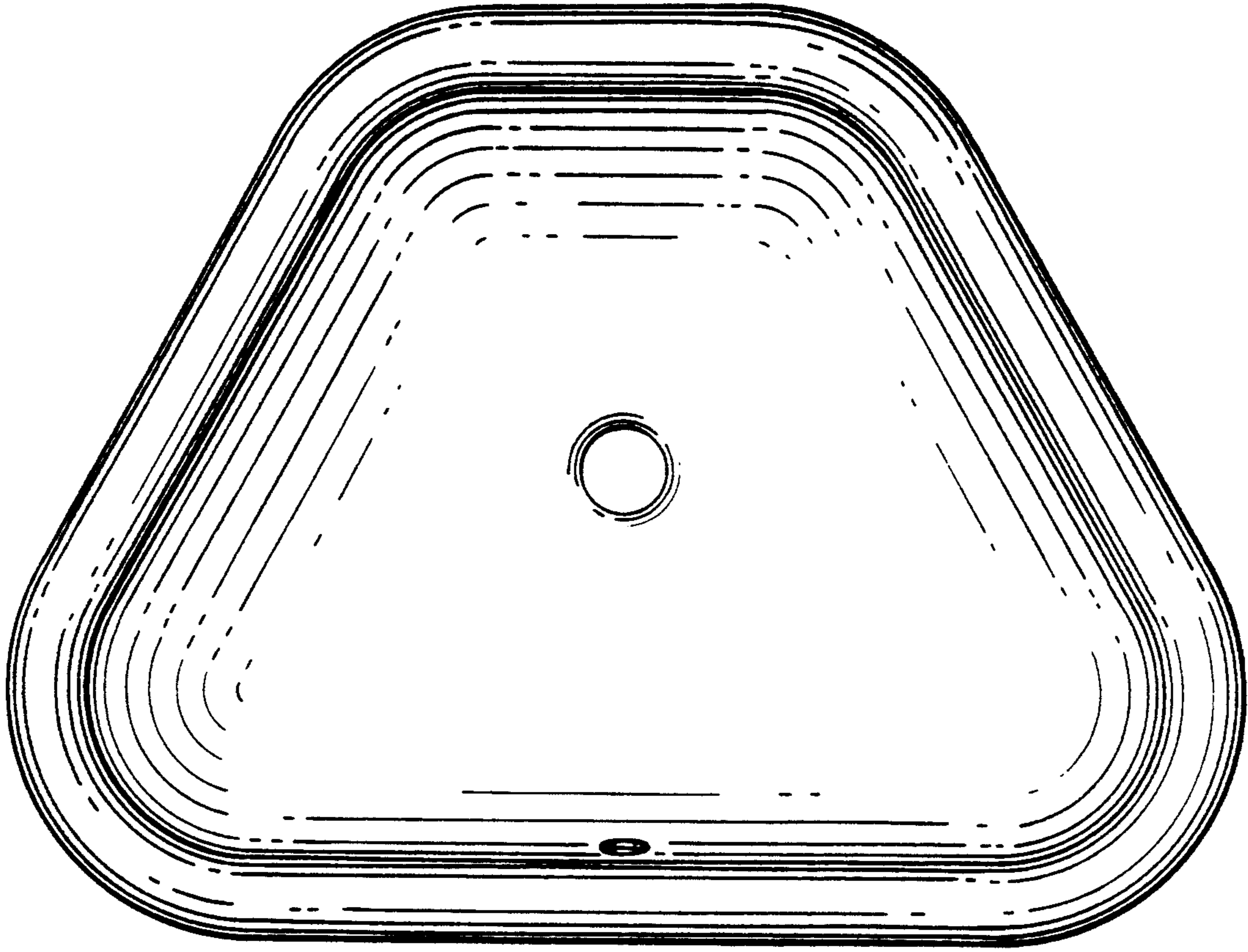

FIG. 27

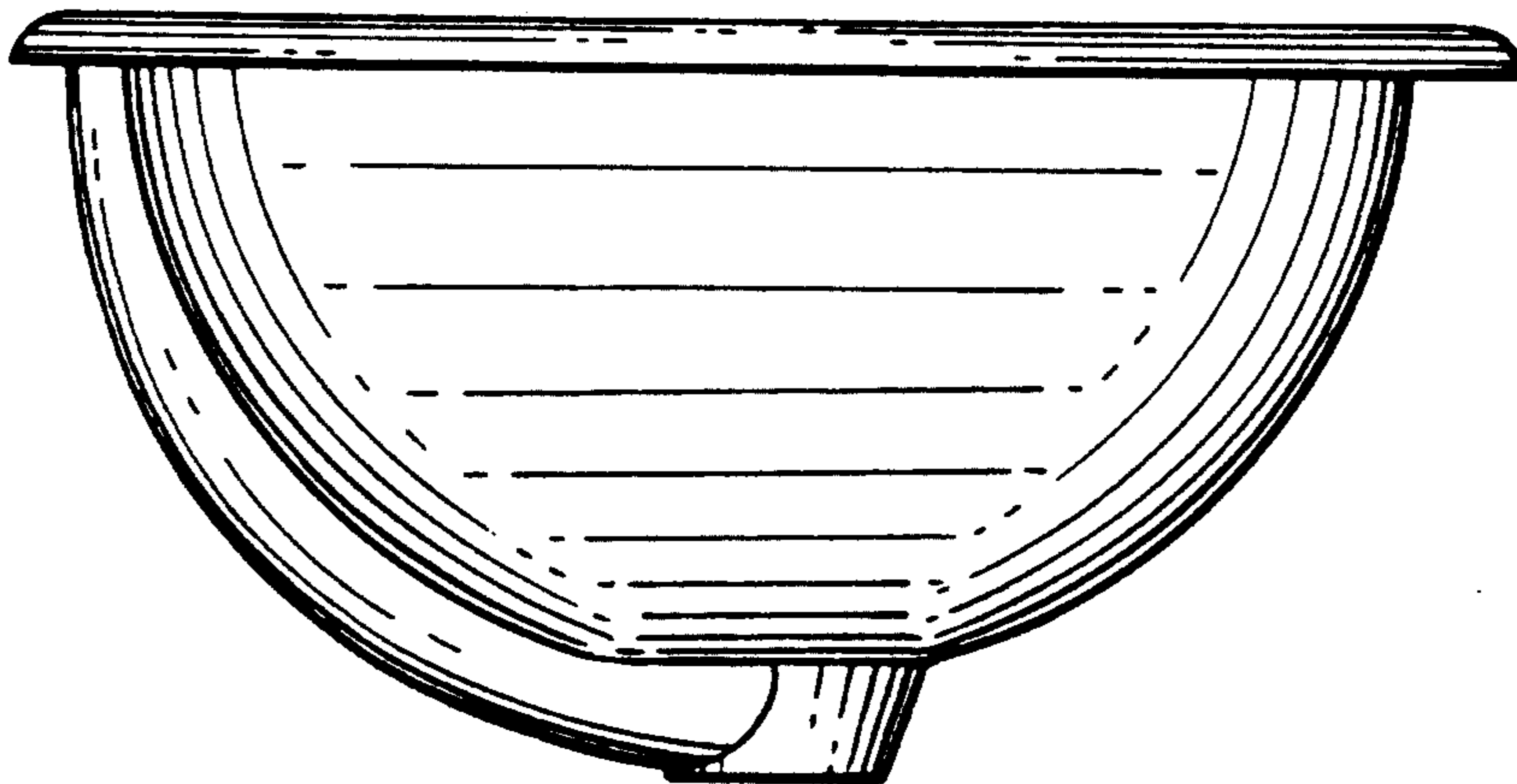

FIG. 28

FIG. 29

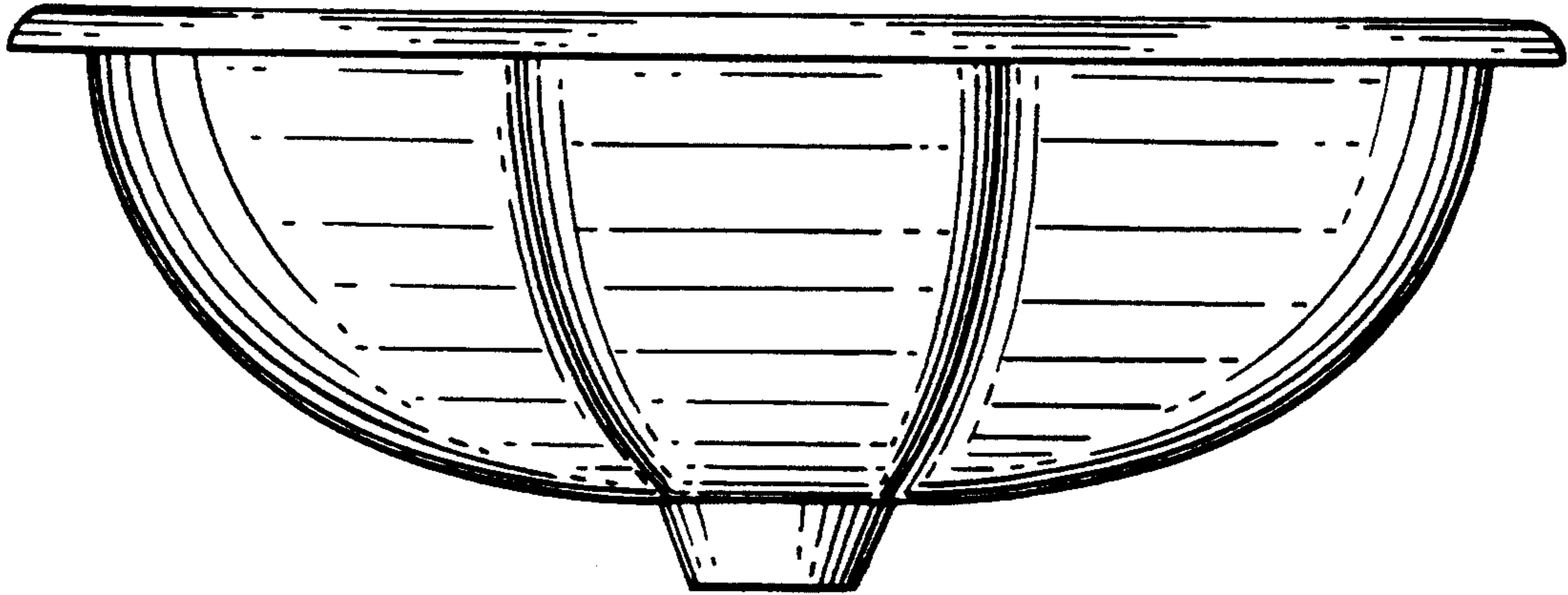

FIG. 30

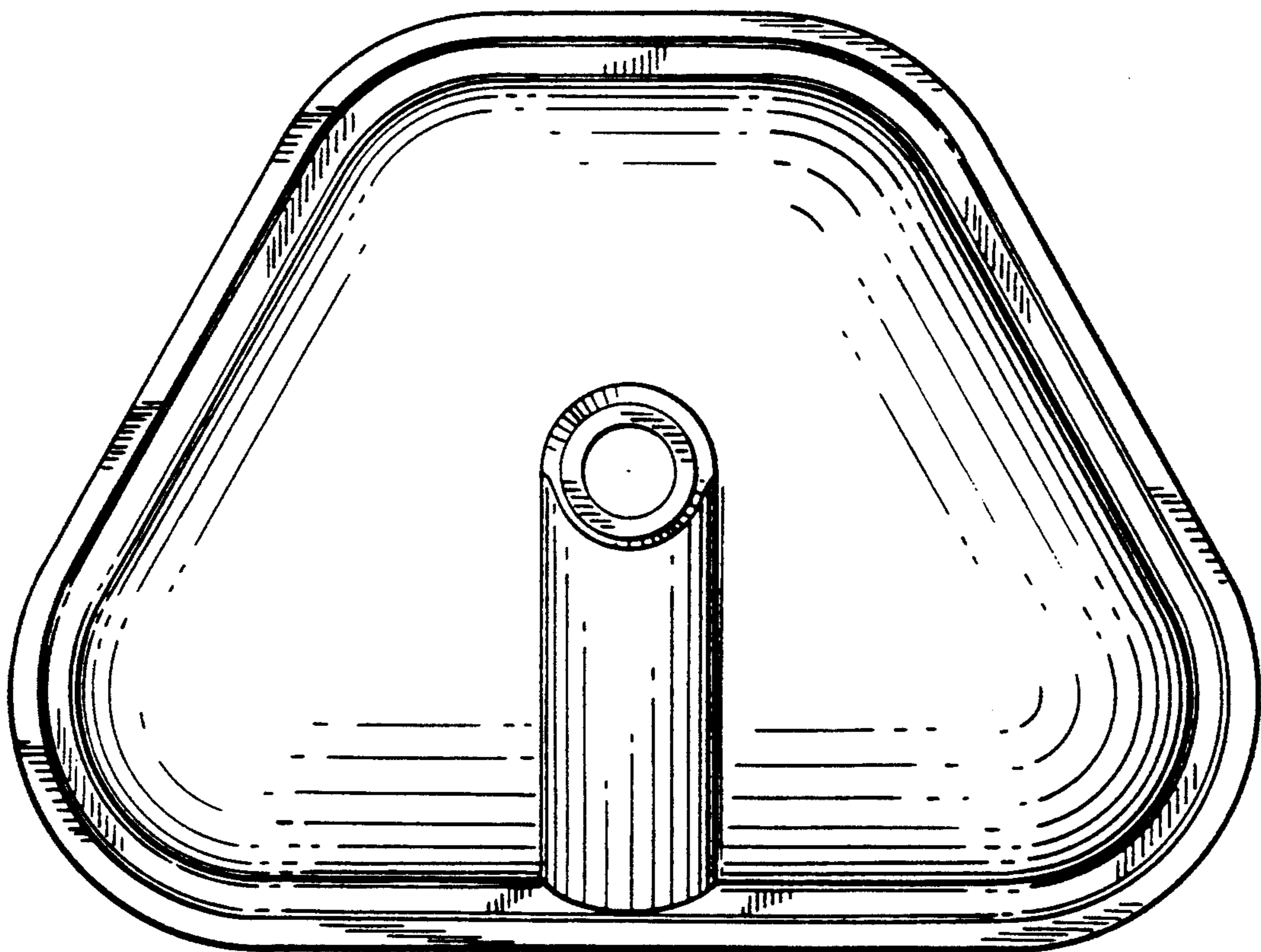

FIG. 31

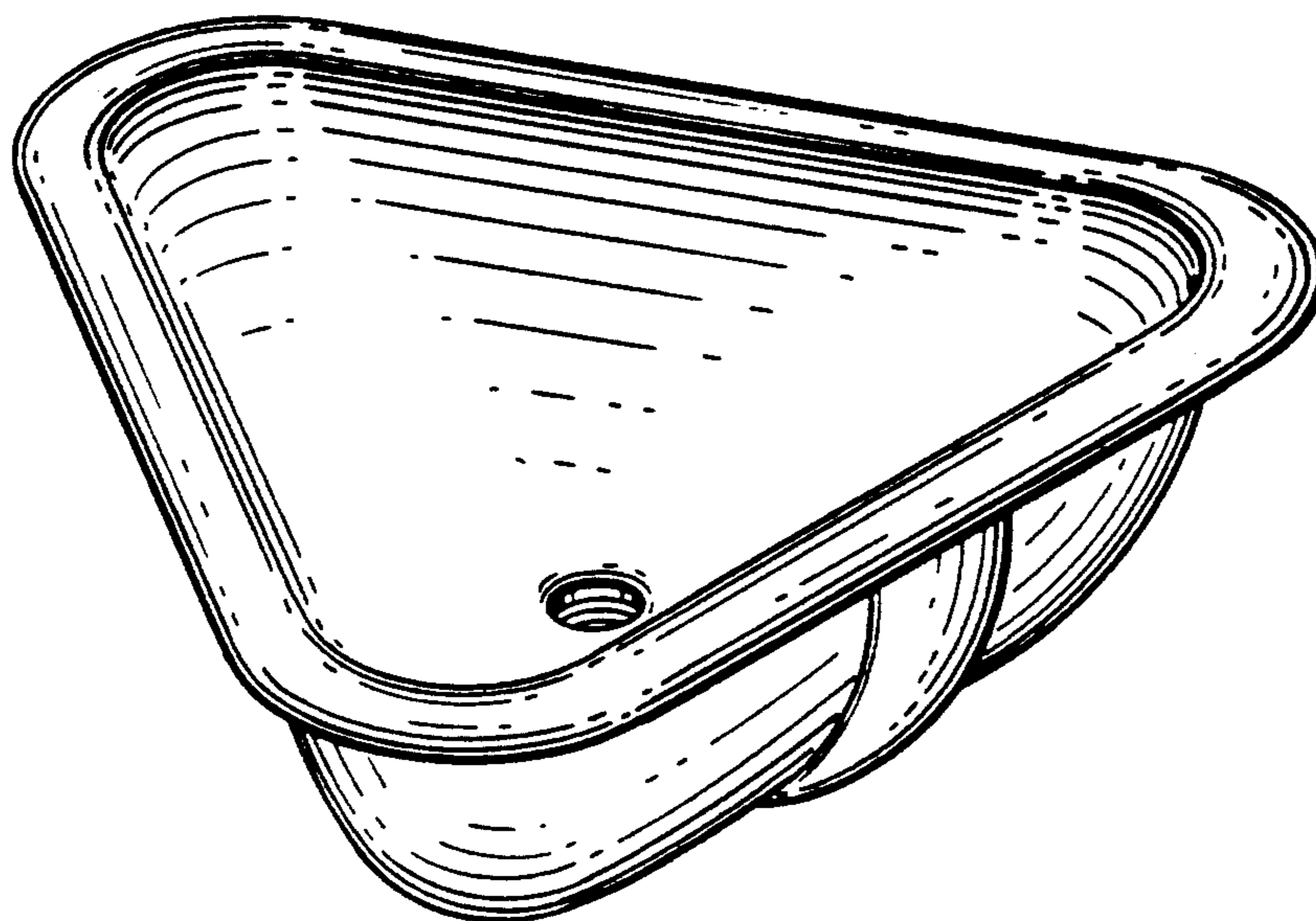

FIG. 32

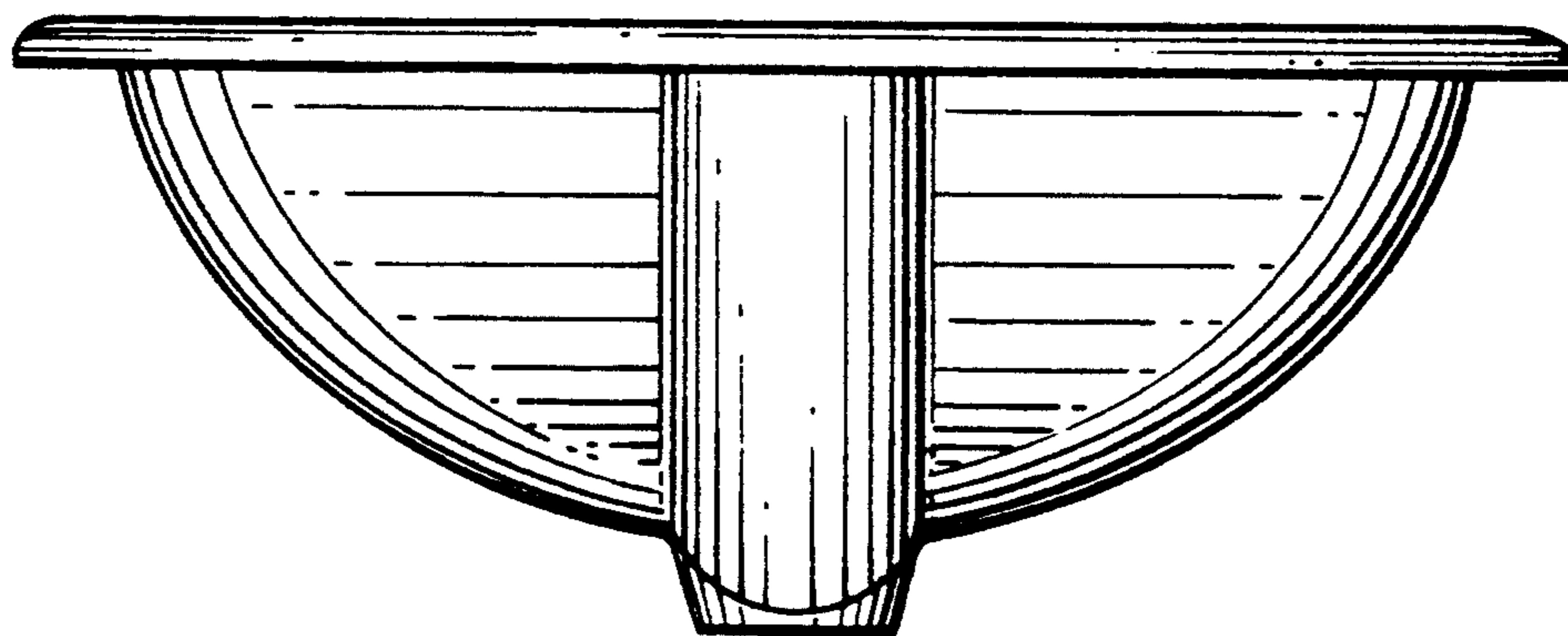

FIG. 33

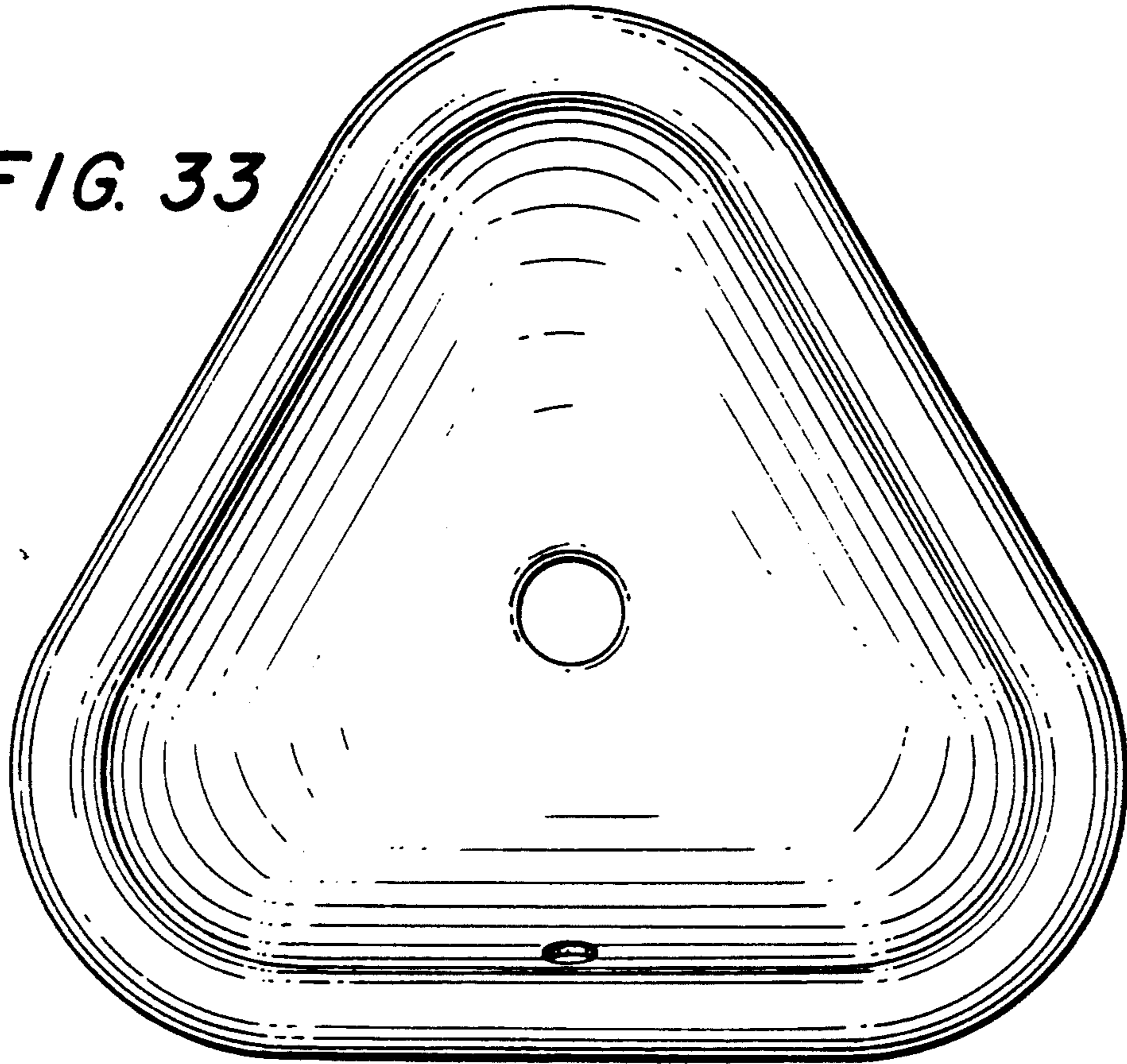

FIG. 34

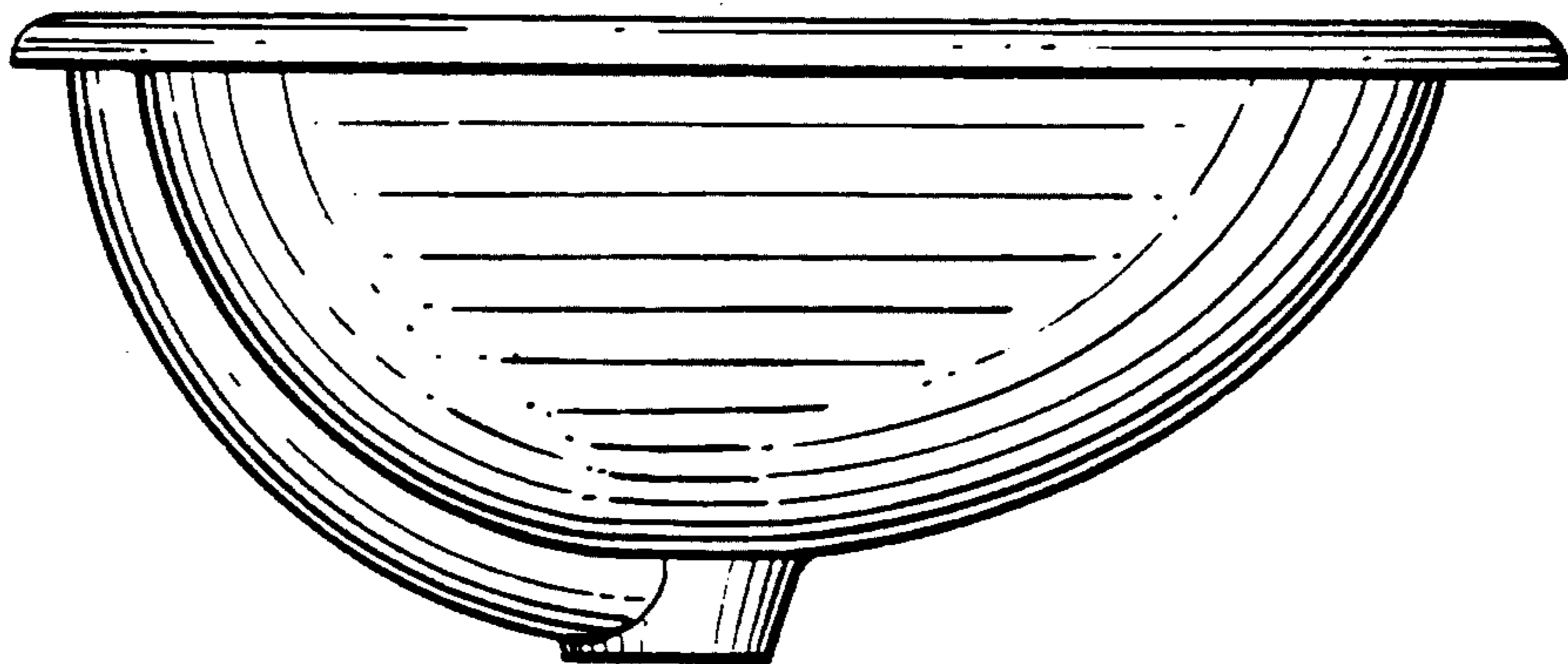

FIG. 35

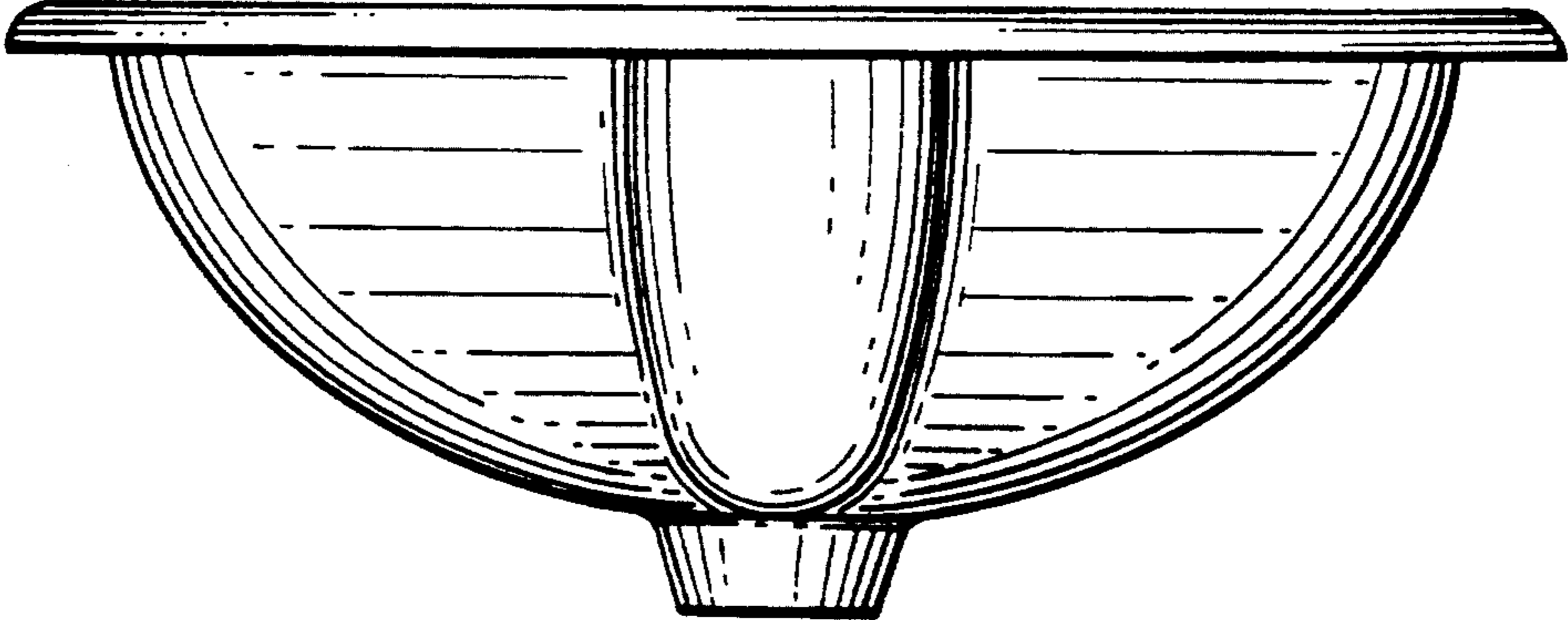

FIG. 36

