



US00D345147S

United States Patent [19]

Fukutake et al.

[11] Patent Number: **Des. 345,147**

[45] Date of Patent: **** Mar. 15, 1994**

[54] **PEN-BASED PERSONAL COMPUTER**

[75] Inventors: **Katsuyuki Fukutake; Yoshihiro Ueda; Masaharu Kasahara; Shigeru Hidesawa**, all of Kawasaki, Japan; **Mark A. Schiebl**, Fremont, Calif.; **Neil R. Taylor**, Alameda, Calif.; **Robin W. Chu**, San Francisco, Calif.

[73] Assignee: **Fujitsu Limited**, Kawasaki, Japan

[**] Term: **14 Years**

[21] Appl. No.: **917,442**

[22] Filed: **Jul. 22, 1992**

[52] U.S. Cl. **D14/100**

[58] Field of Search 340/700, 706; 364/708, 364/709.04; 361/390, 394; 178/18, 19; D14/100, 105, 106, 107, 113, 115; D18/1, 7; D19/52

[56] **References Cited**

U.S. PATENT DOCUMENTS

D. 273,788 5/1984 Ault D14/100 X
D. 307,134 4/1990 Makidera D14/100
D. 333,814 3/1993 Swanson et al. D14/100
4,972,496 11/1990 Sklarew D14/100 X

Primary Examiner—Wallace R. Burke
Assistant Examiner—Freda S. Nunn
Attorney, Agent, or Firm—Staas & Halsey

[57] **CLAIM**

The ornamental design for a pen-based personal computer, as shown.

DESCRIPTION

FIG. 1 is a left side elevational view of our pen-based personal computer design;
FIG. 2 is a front elevational view thereof;
FIG. 3 is a right side elevational view thereof;
FIG. 4 is a rear elevational view thereof;
FIG. 5 is a top plan view thereof;
FIG. 6 is a bottom plan view thereof; and,
FIG. 7 is a perspective view thereof.

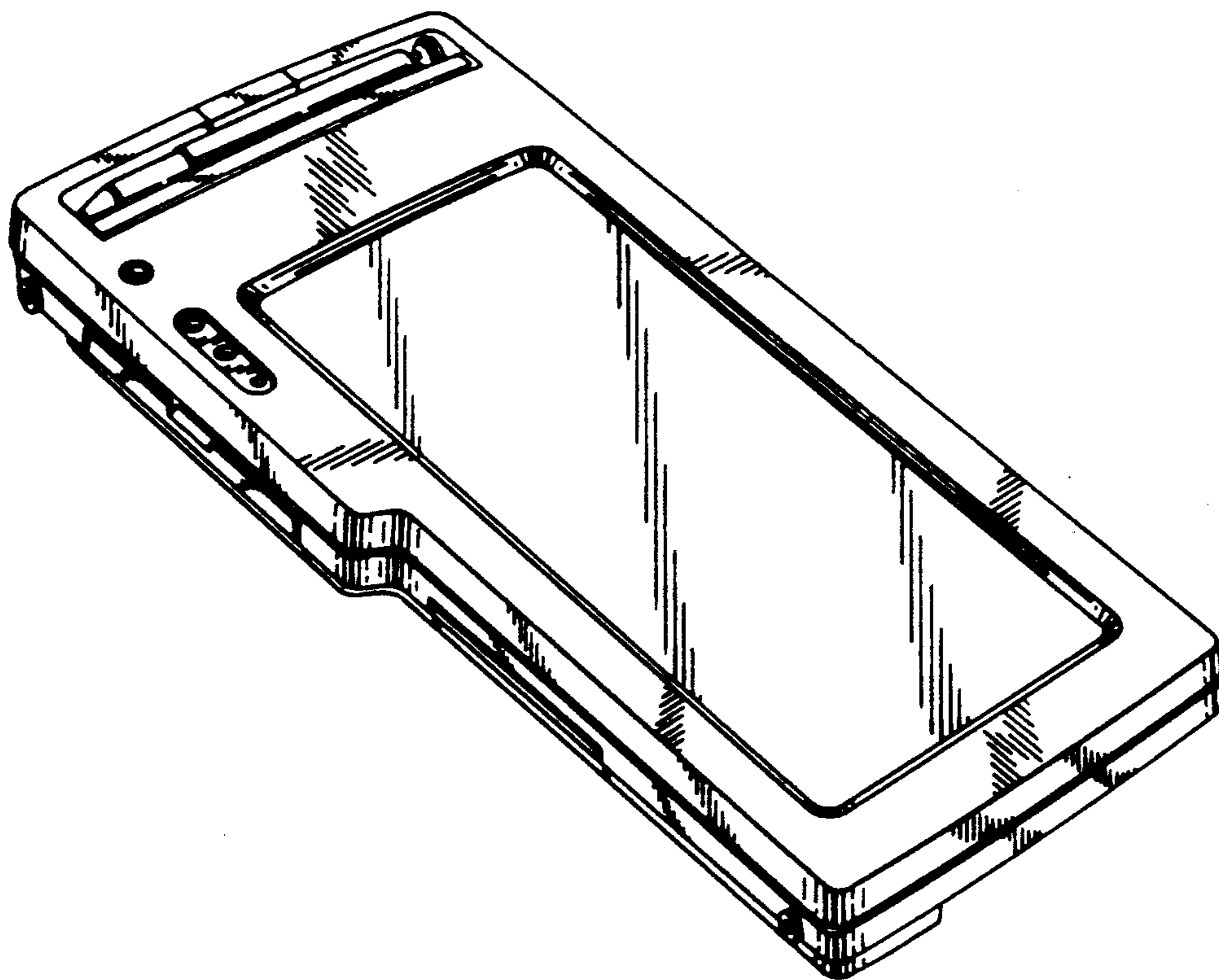

FIG. 3

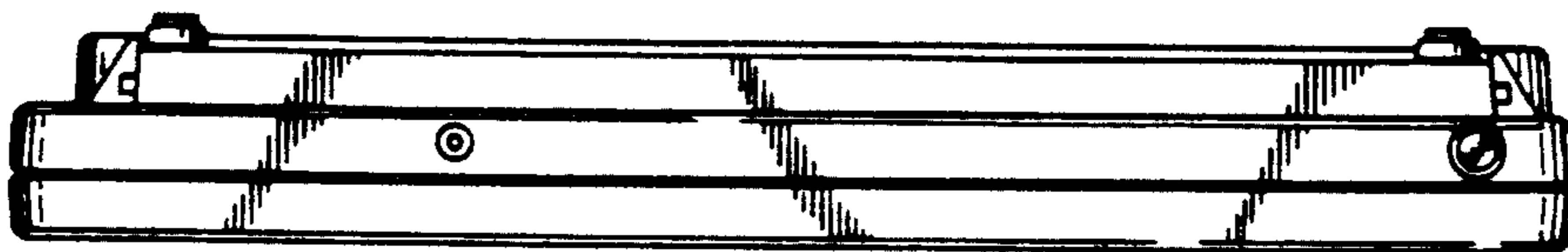

FIG. 2

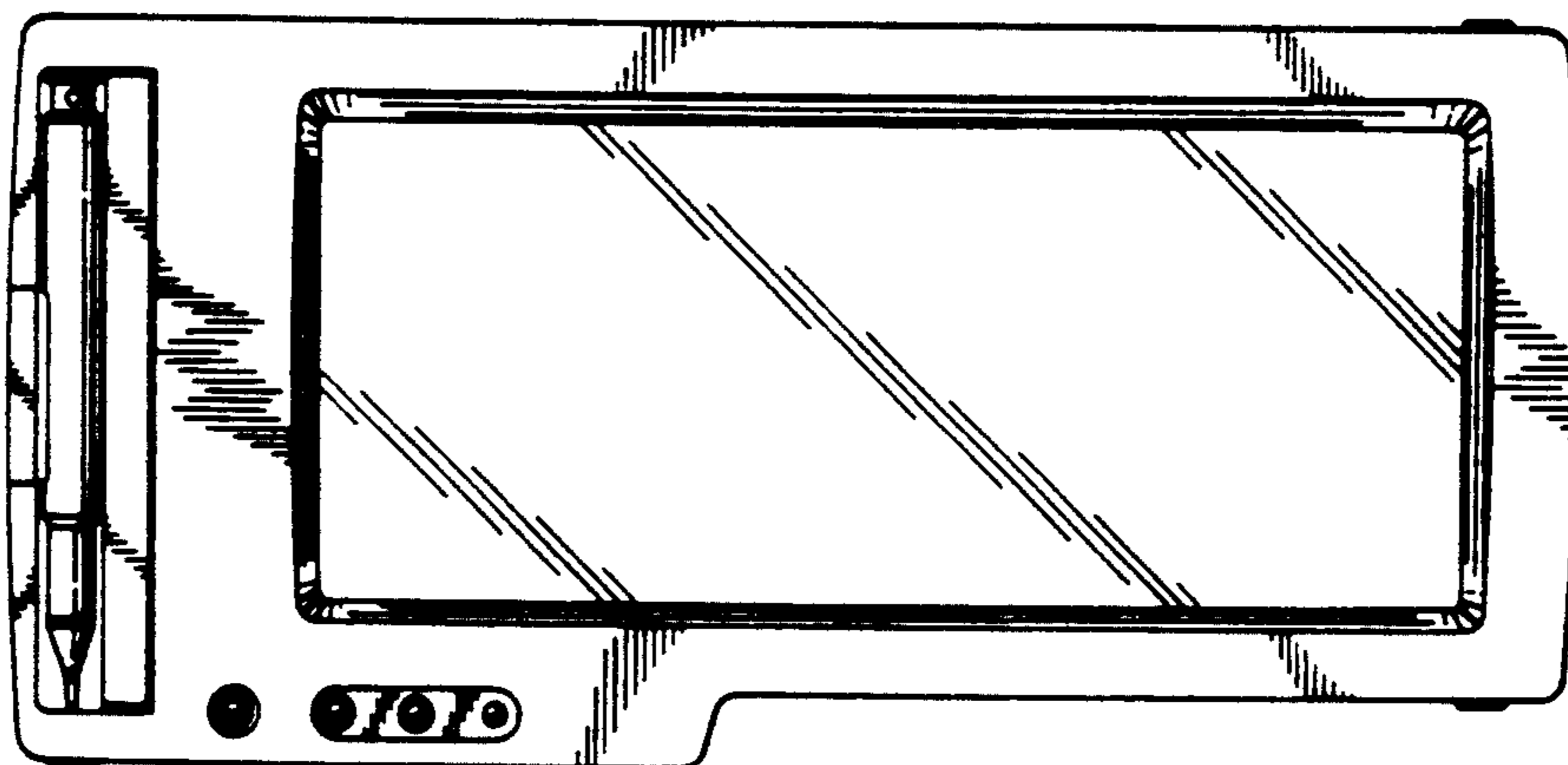

FIG. 1

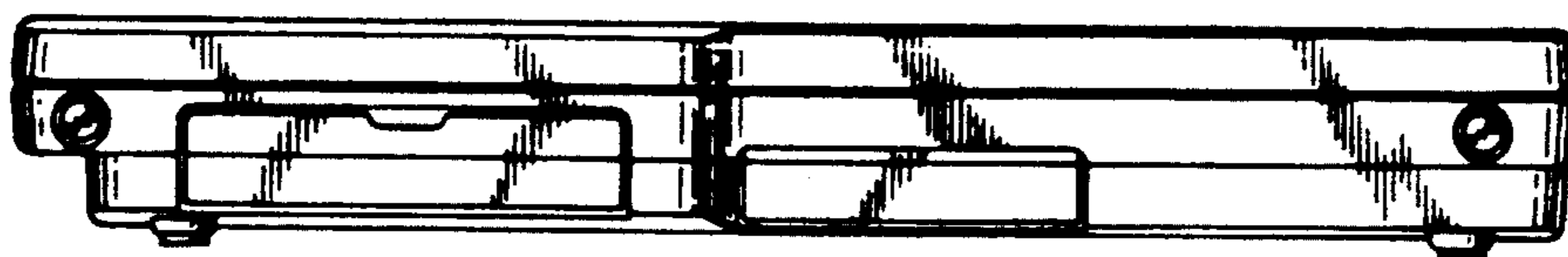

FIG. 4

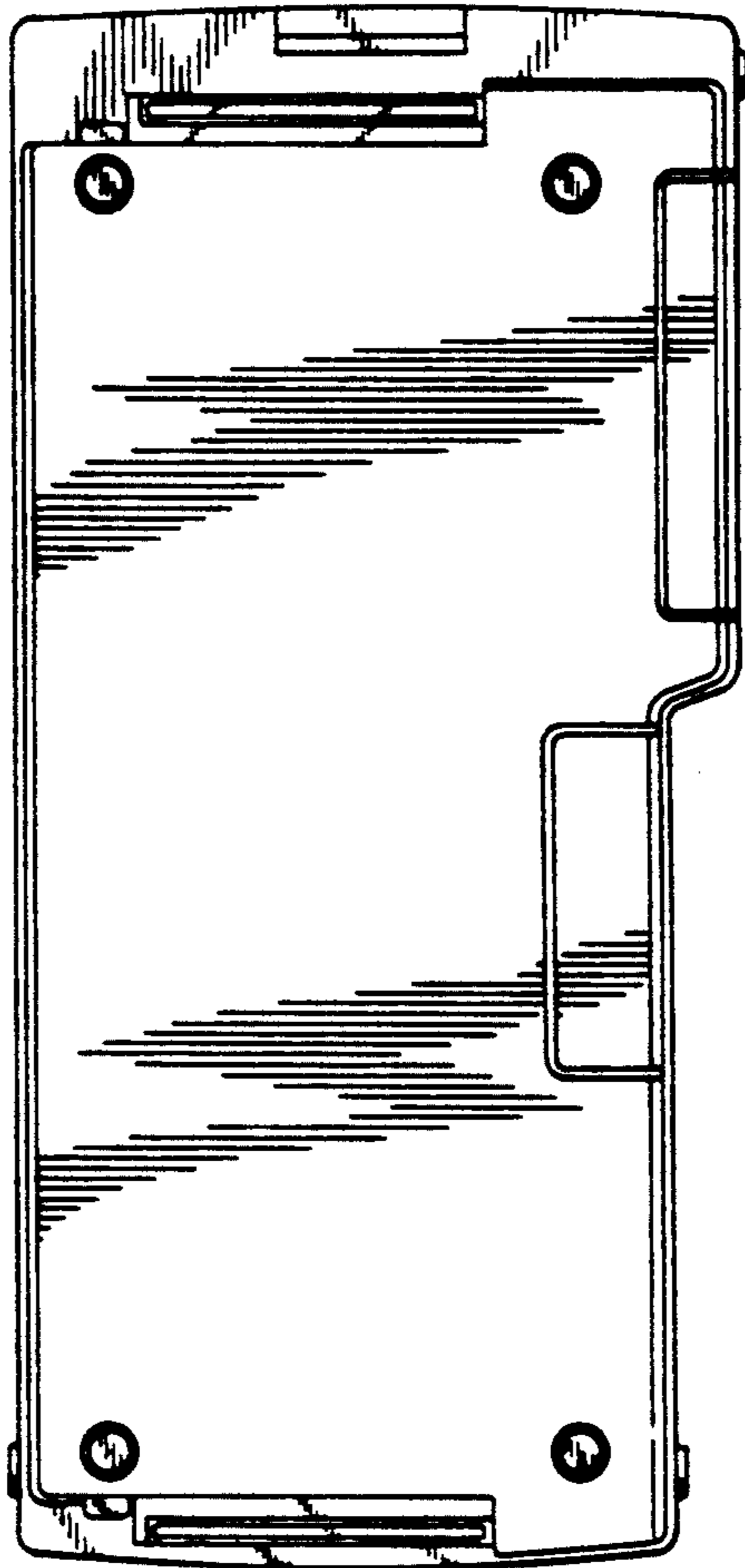

FIG. 5

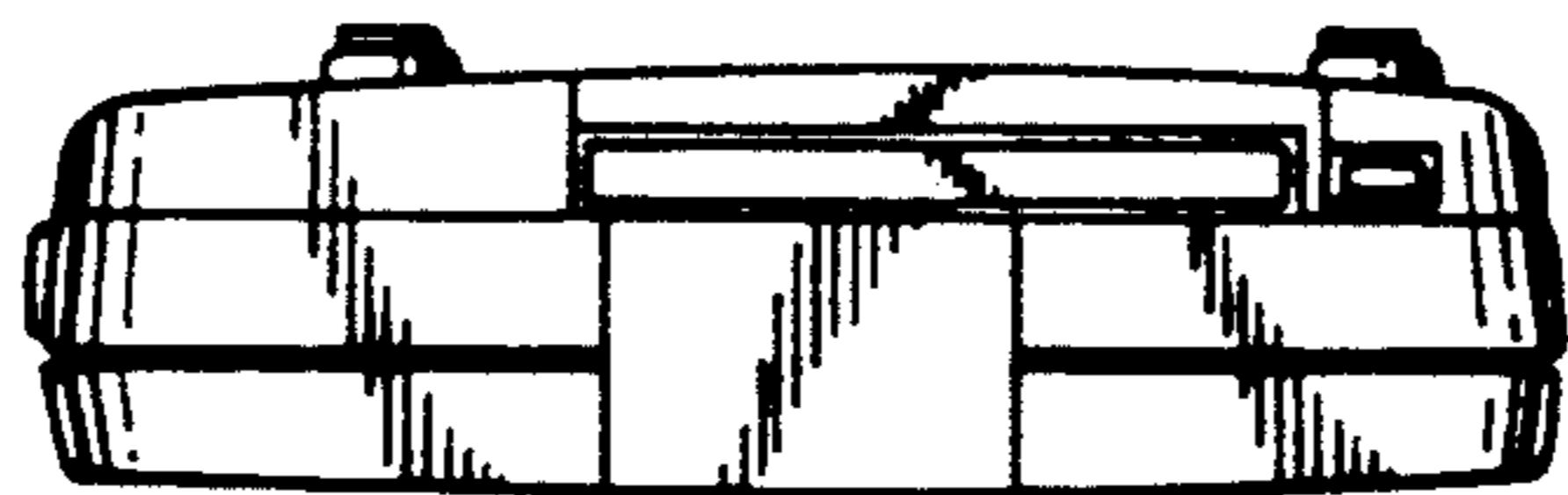

FIG. 6

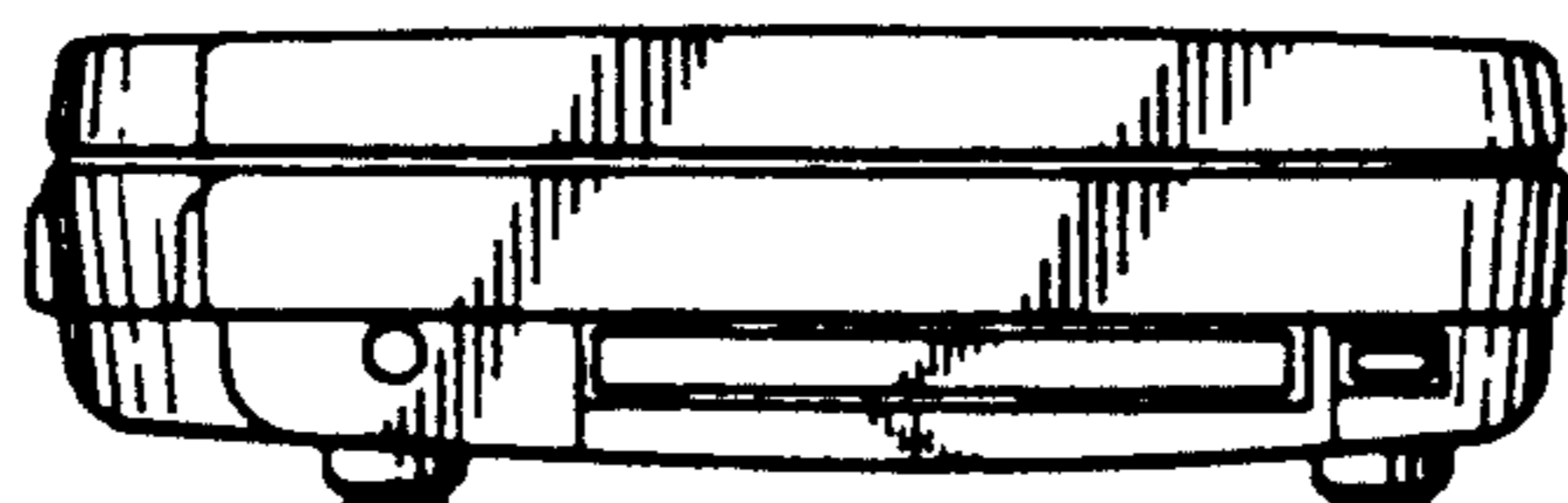

FIG. 7

