



US00D345067S

United States Patent [19]

Shafer

[11] Patent Number: **Des. 345,067**

[45] Date of Patent: **** Mar. 15, 1994**

[54] SOAP DISH

[75] Inventor: **Mary A. Shafer, Indianapolis, Ind.**

[73] Assignee: **Franklin Plastic Products, Inc., Franklin, Ind.**

[**] Term: **14 Years**

[21] Appl. No.: **833,893**

[22] Filed: **Feb. 11, 1992**

[52] U.S. Cl. **D6/536**

[58] Field of Search **D6/536, 539-540, D6/529; 206/77.1; 211/13, 60.1, 65, 66, 87-88; 248/309.2**

D. 272,588 2/1984 Shames et al. D6/540
D. 291,638 9/1987 Chap D6/540
D. 332,367 1/1993 McKeone et al. D6/540

Primary Examiner—Brian N. Vinson
Attorney, Agent, or Firm—Woodard, Emhardt, Naughton, Moriarty & McNett

[57] CLAIM

The ornamental design for a soap dish, as shown and described.

DESCRIPTION

FIG. 1 is a top plan view of a soap dish showing my new design;
FIG. 2 is a front elevational view thereof, the rear being identical in appearance;
FIG. 3 is a side elevational view thereof, the opposite side being identical in appearance;
FIG. 4 is a bottom plan view thereof;
FIG. 5 is a vertical cross-sectional view thereof, taken in the direction of lines 5—5 of FIG. 1; and,
FIG. 6 is a vertical cross-sectional view thereof, taken in the direction of lines 6—6 of FIG. 1.

[56] References Cited

U.S. PATENT DOCUMENTS

- D. 59,287 10/1921 Sailer .
- D. 72,367 4/1927 Froelking .
- D. 103,824 3/1937 Murrin .
- D. 162,611 3/1951 Andriessen D6/536
- D. 184,873 4/1959 Hvale .

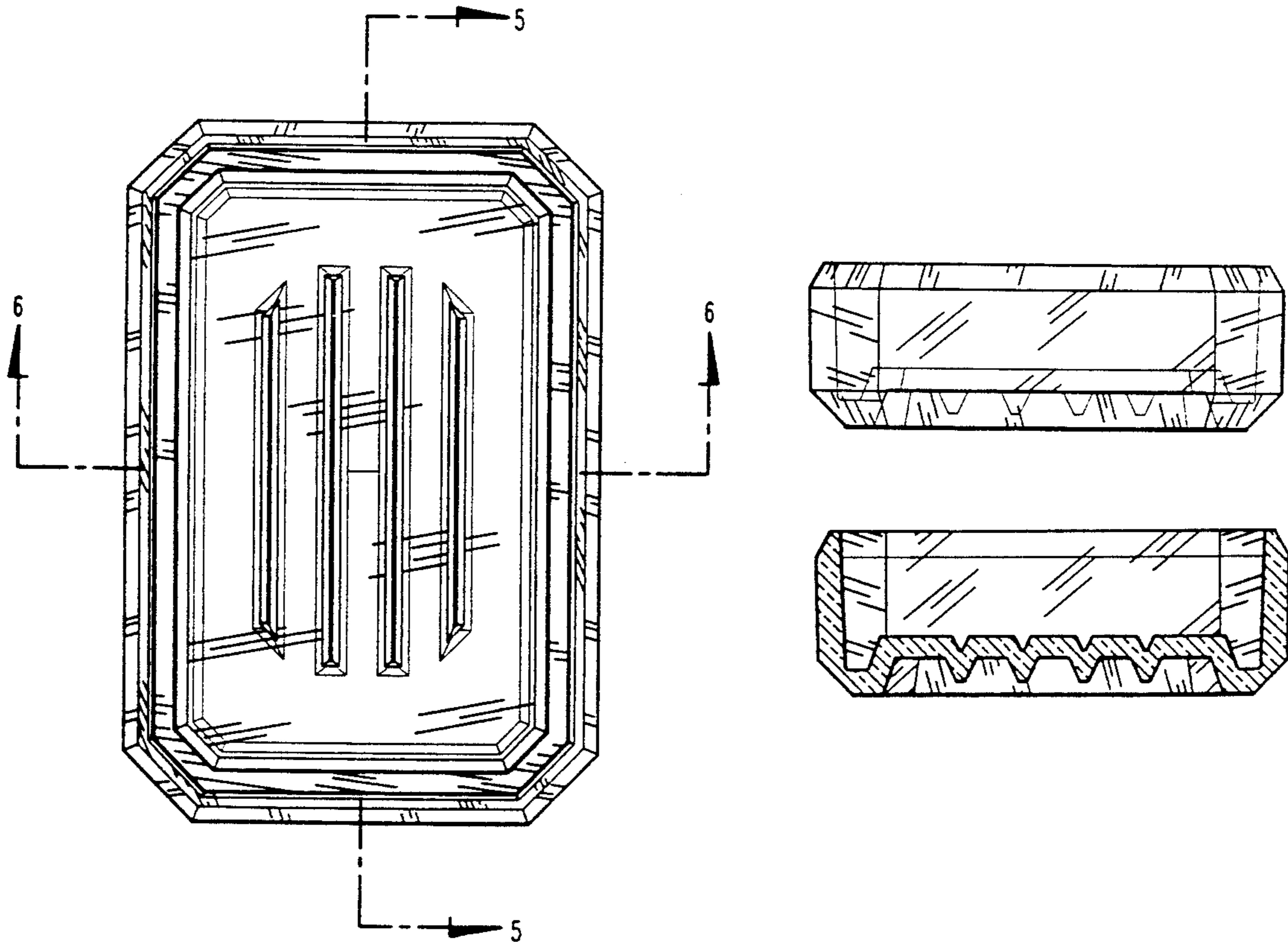

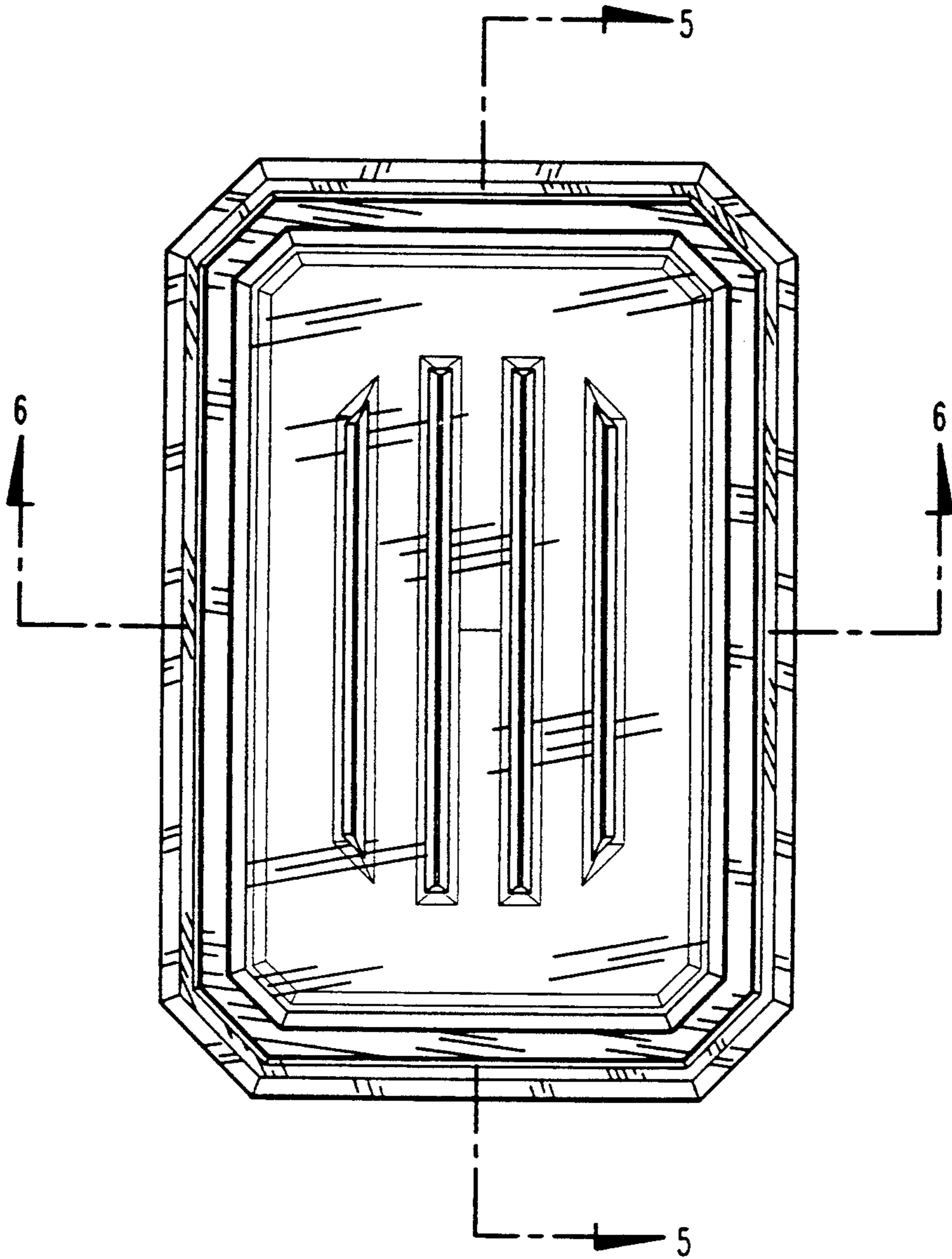

Fig. 1

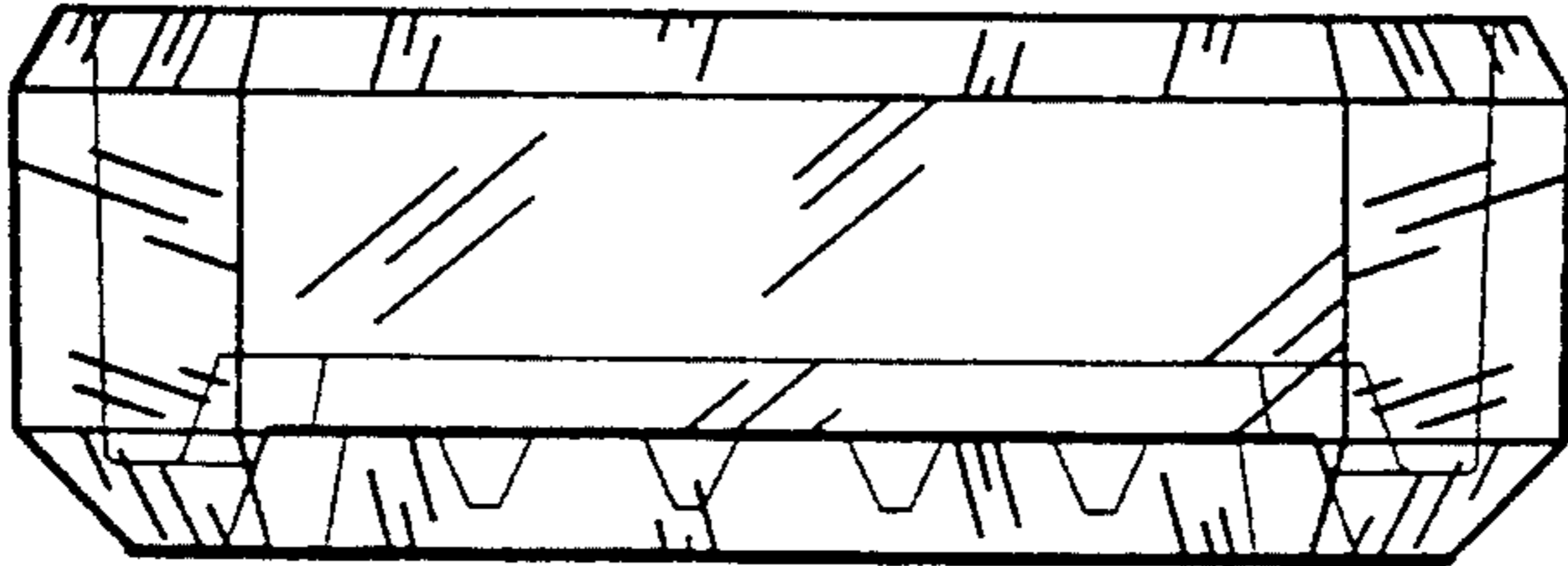

Fig. 3

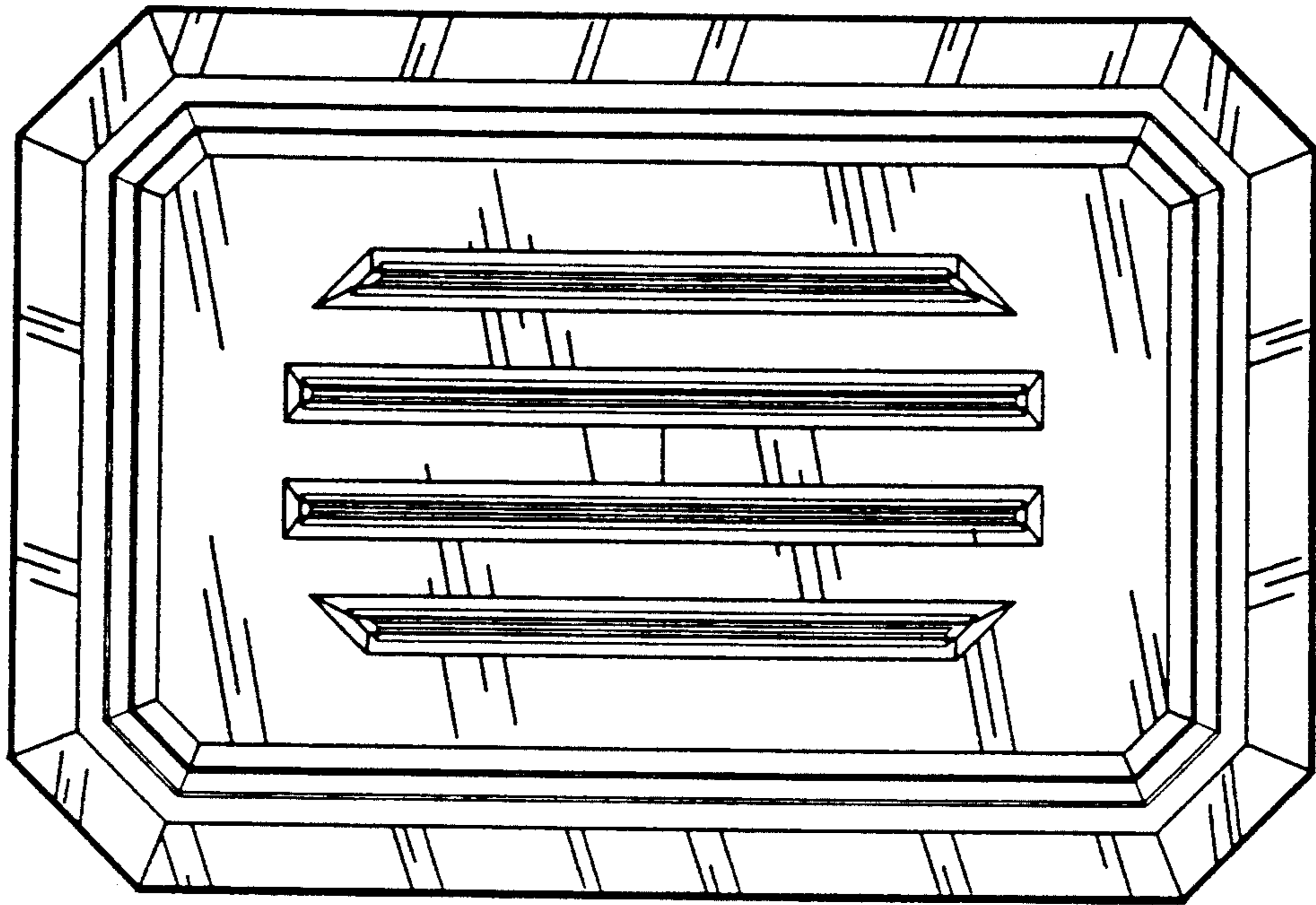

Fig. 4

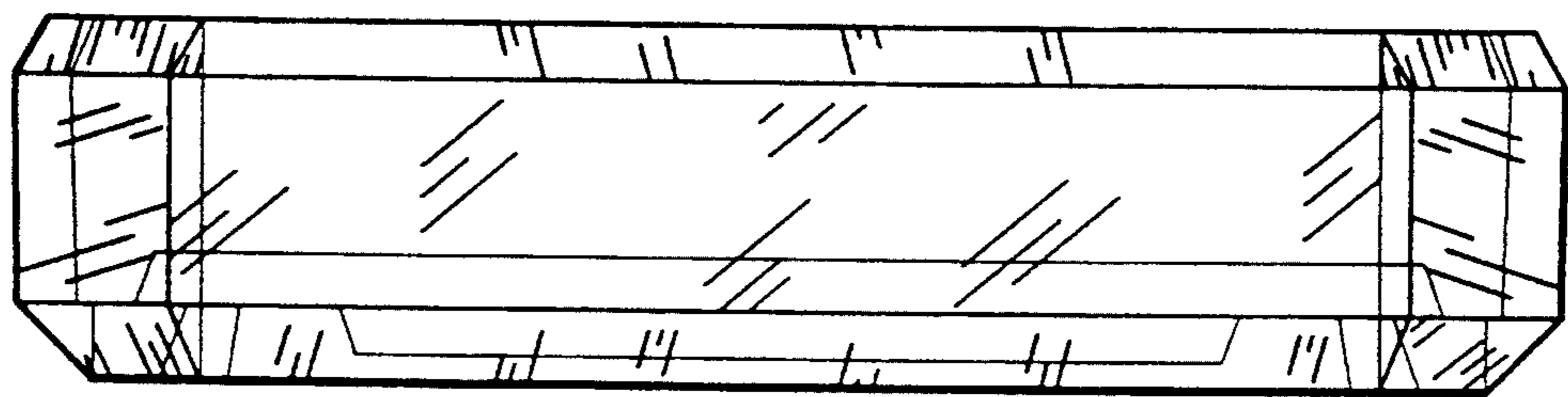

Fig. 2

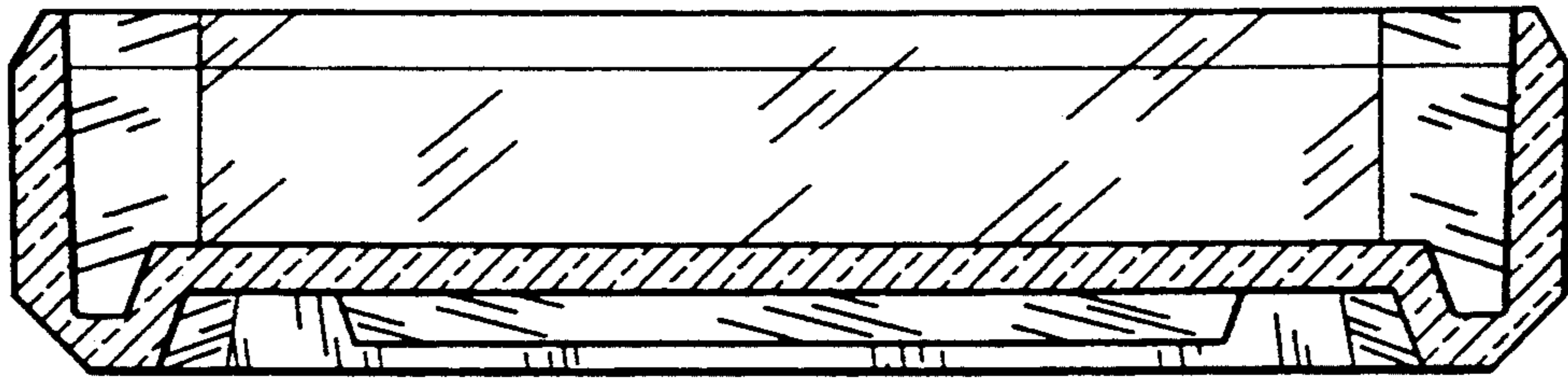

Fig. 5

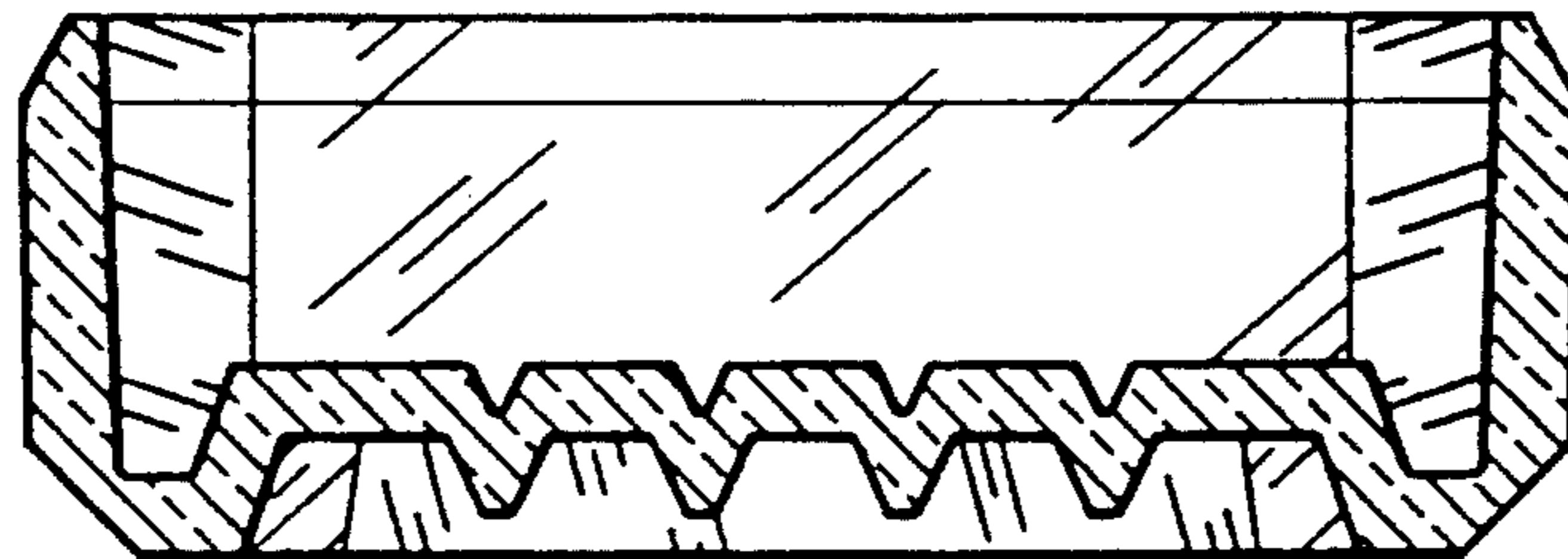

Fig. 6