



US00D345005S

United States Patent [19]

[11] Patent Number: Des. 345,005

Ens

[45] Date of Patent: ** Mar. 8, 1994

[54] WATER INJECTOR FOR FUEL-AIR MIXTURE OF AN AUTOMOTIVE CARBURETOR

4,516,553 5/1985 Lindberg 123/573 X

[76] Inventor: Peter D. Ens, Box 15, Endako, Canada, V0J 1L0

Primary Examiner—Wallace R. Burke
Assistant Examiner—M. H. Tung
Attorney, Agent, or Firm—S. Michael Bender

[**] Term: 14 Years

[57] CLAIM

[21] Appl. No.: 747,115

The ornamental design for a water injector for fuel-air mixture of an automotive carburetor, as shown and described.

[22] Filed: Aug. 19, 1991

DESCRIPTION

[52] U.S. Cl. D23/200

[58] Field of Search 123/572-573, 123/557, 590; D8/1, 2; 239/375-379, 289, 333, 443, 446; D23/200, 213, 202, 205; D12/155

FIG. 1 is a front elevational view of the water injector for fuel-air mixture of an automobile carburetor showing my new design;

FIG. 2 is a rear elevational view thereof;

FIG. 3 is a left side elevational view thereof;

FIG. 4 is a right side elevational view thereof;

FIG. 5 is a top plan view thereof;

FIG. 6 is a bottom plan view thereof; and,

FIG. 7 is a perspective view of the invention showing a use thereof.

The broken line showing the carburetor gasket in FIG. 7 is for illustrative purposes only and forms no part of the claimed design.

[56] References Cited

U.S. PATENT DOCUMENTS

D. 272,941	3/1984	Burns	D23/200 X
D. 285,282	8/1986	Ariaz et al.	D8/2
D. 299,483	1/1989	Hansen	D8/1
D. 332,205	1/1993	Sessions	D8/1
4,409,950	10/1983	Goldberg	123/572 X
4,483,309	11/1984	Norman et al.	123/572 X

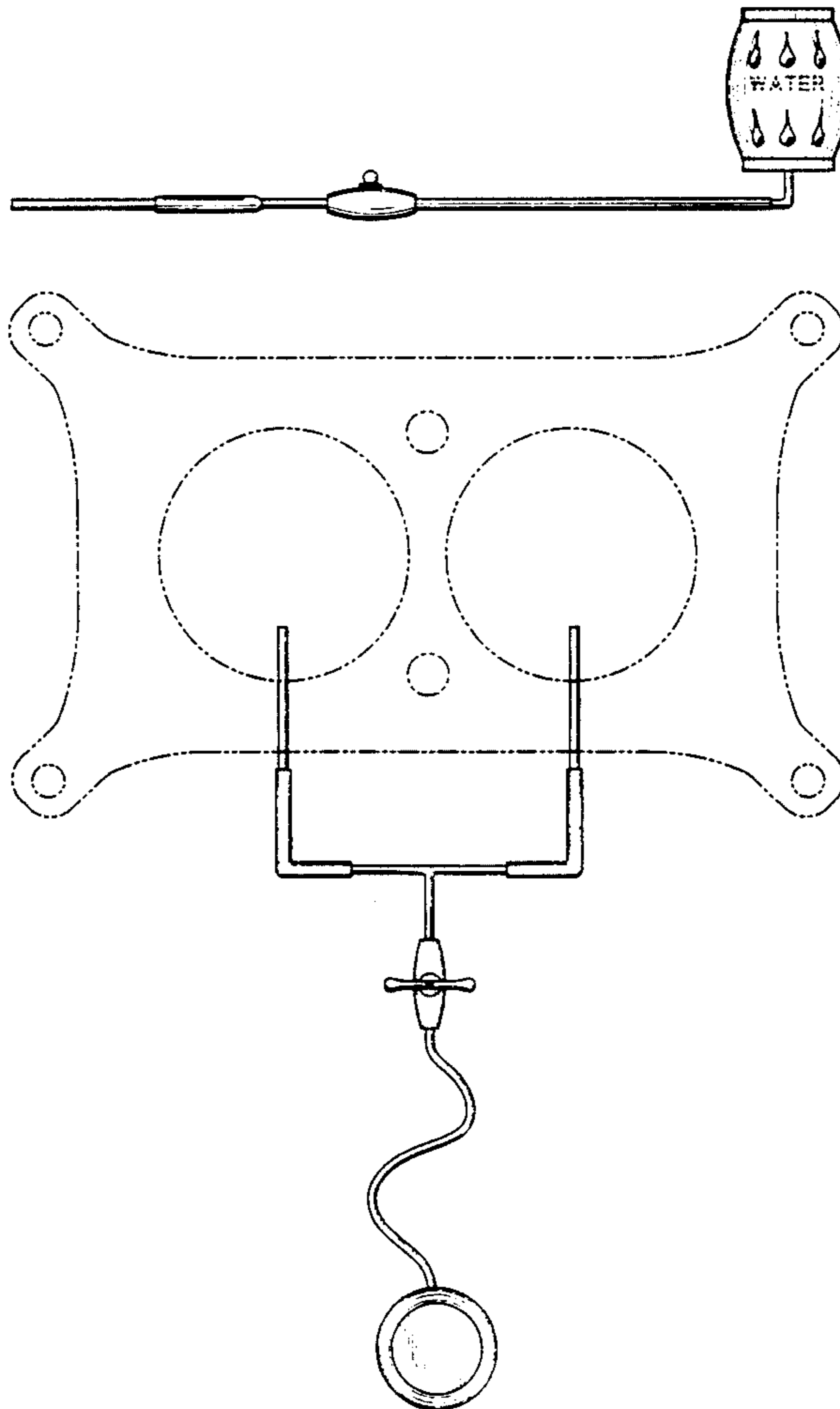

FIG. 1

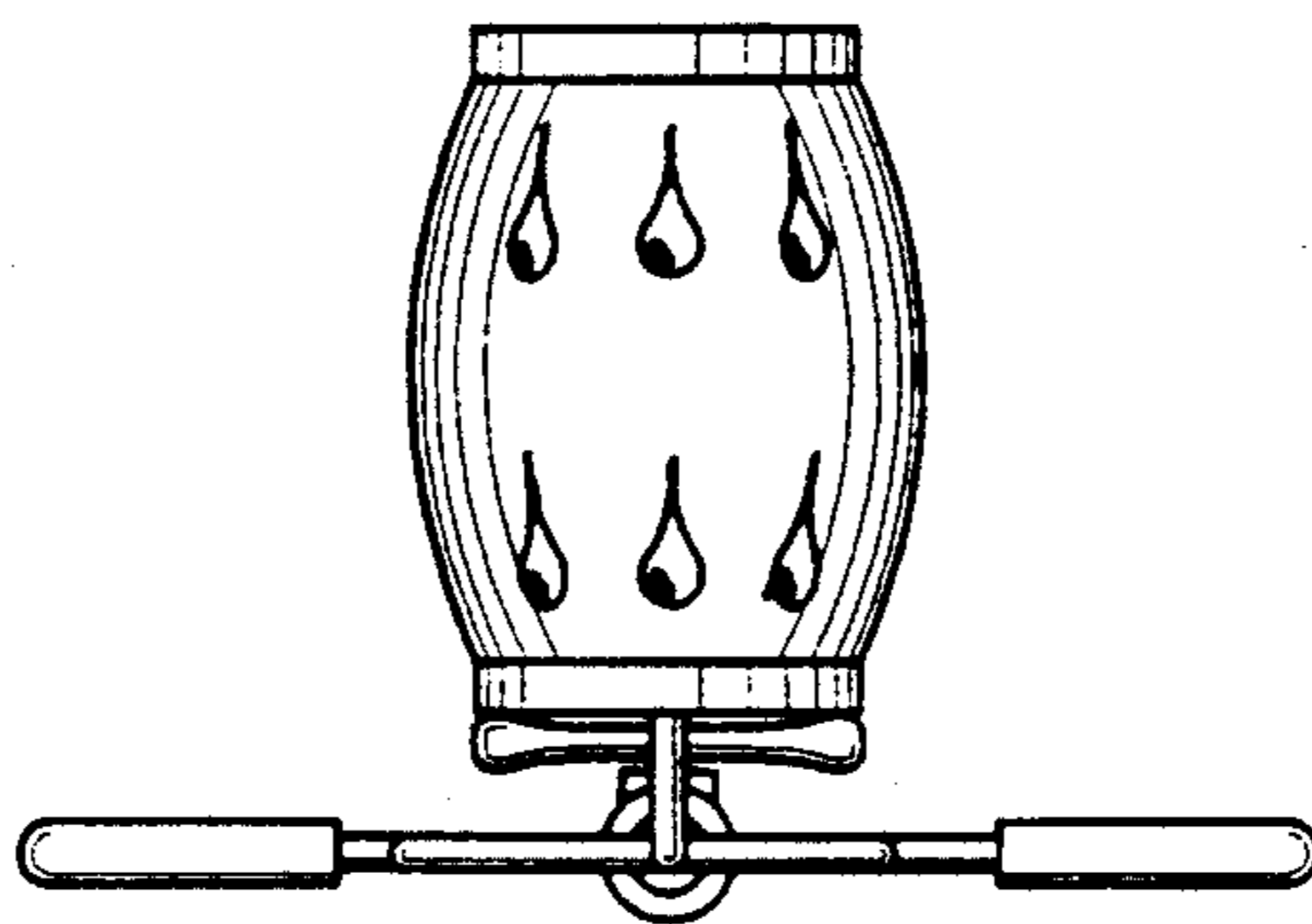

FIG. 2

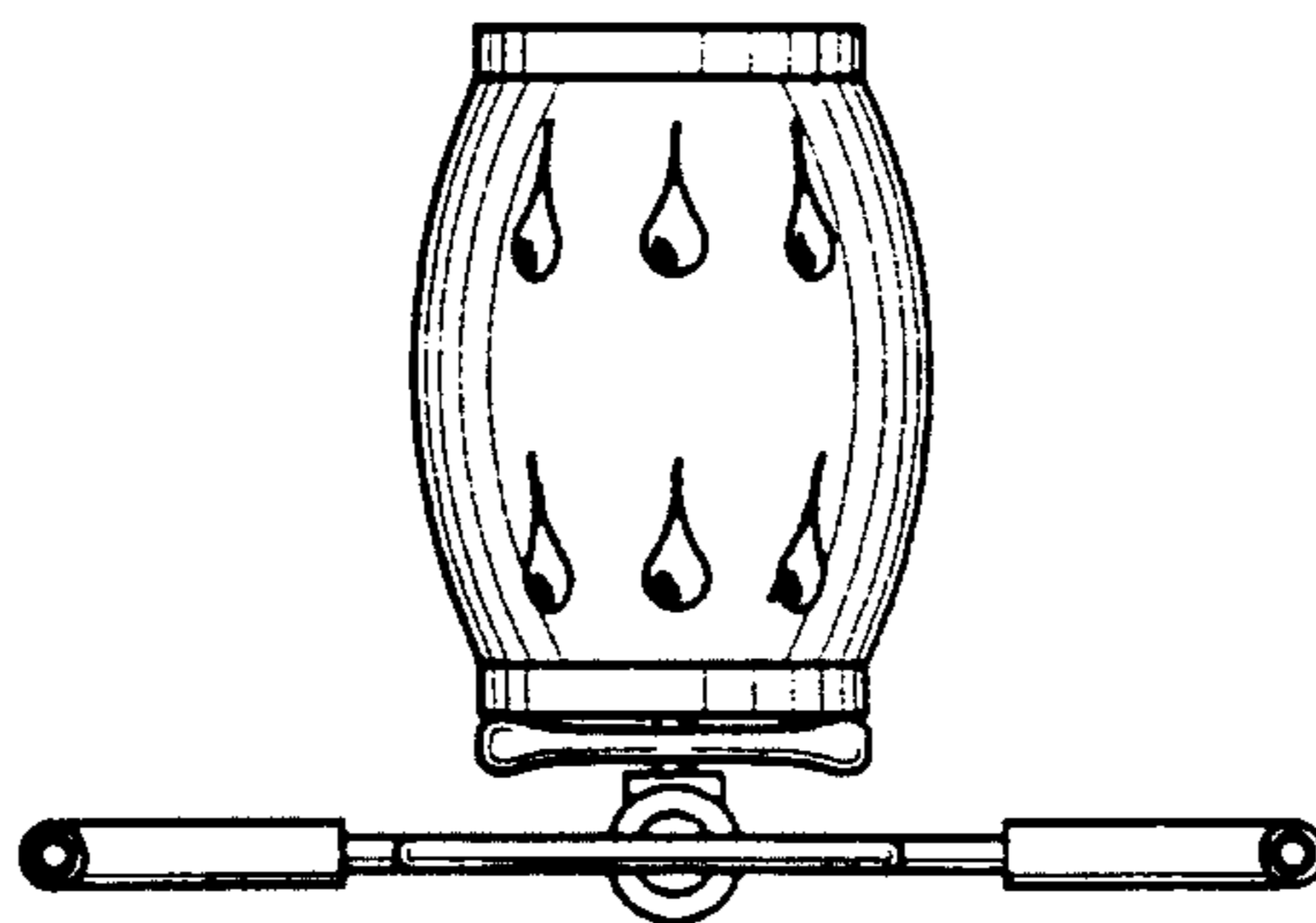

FIG. 3

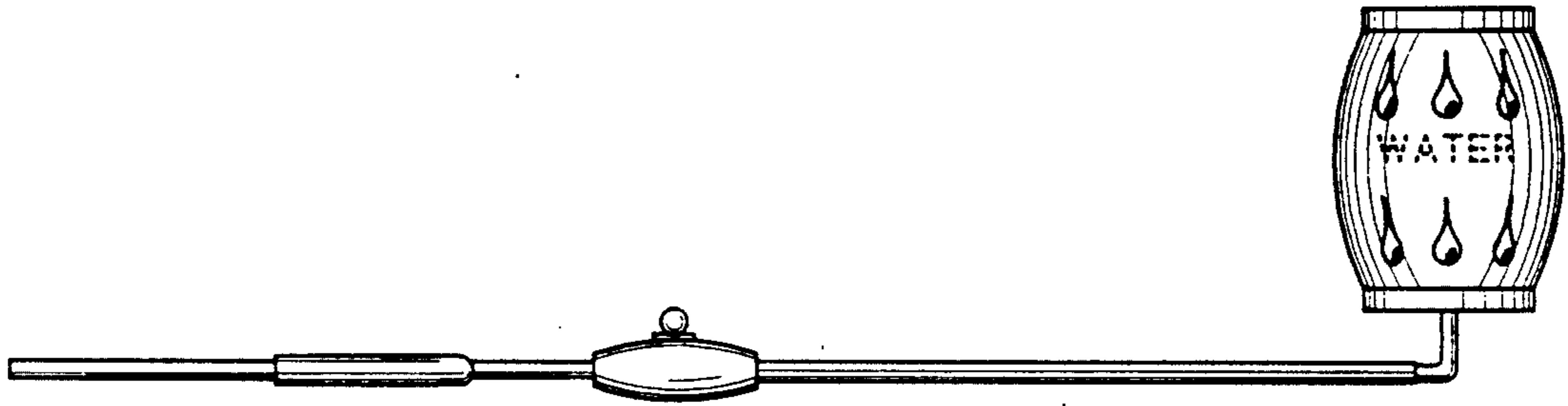

FIG. 4

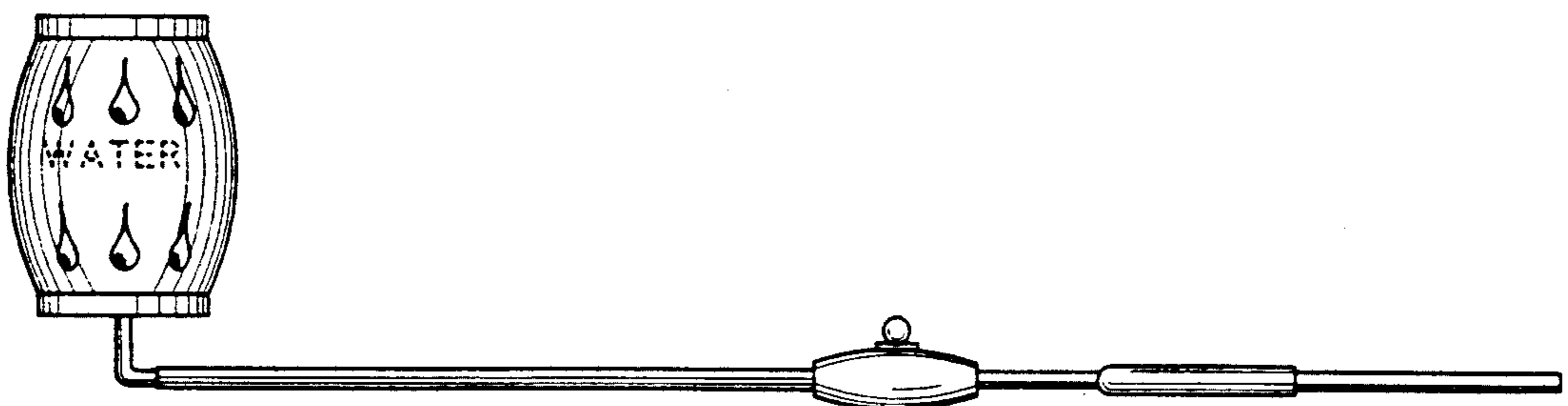

FIG. 5

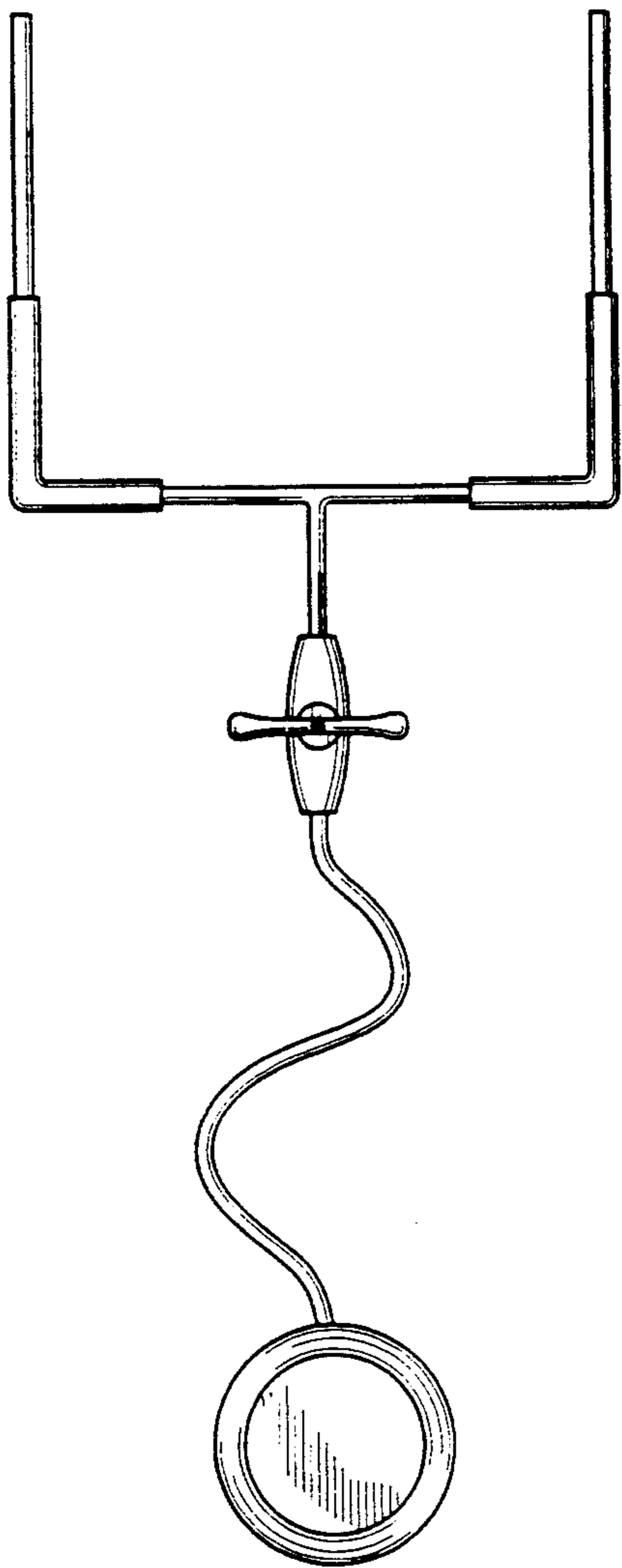

FIG. 6

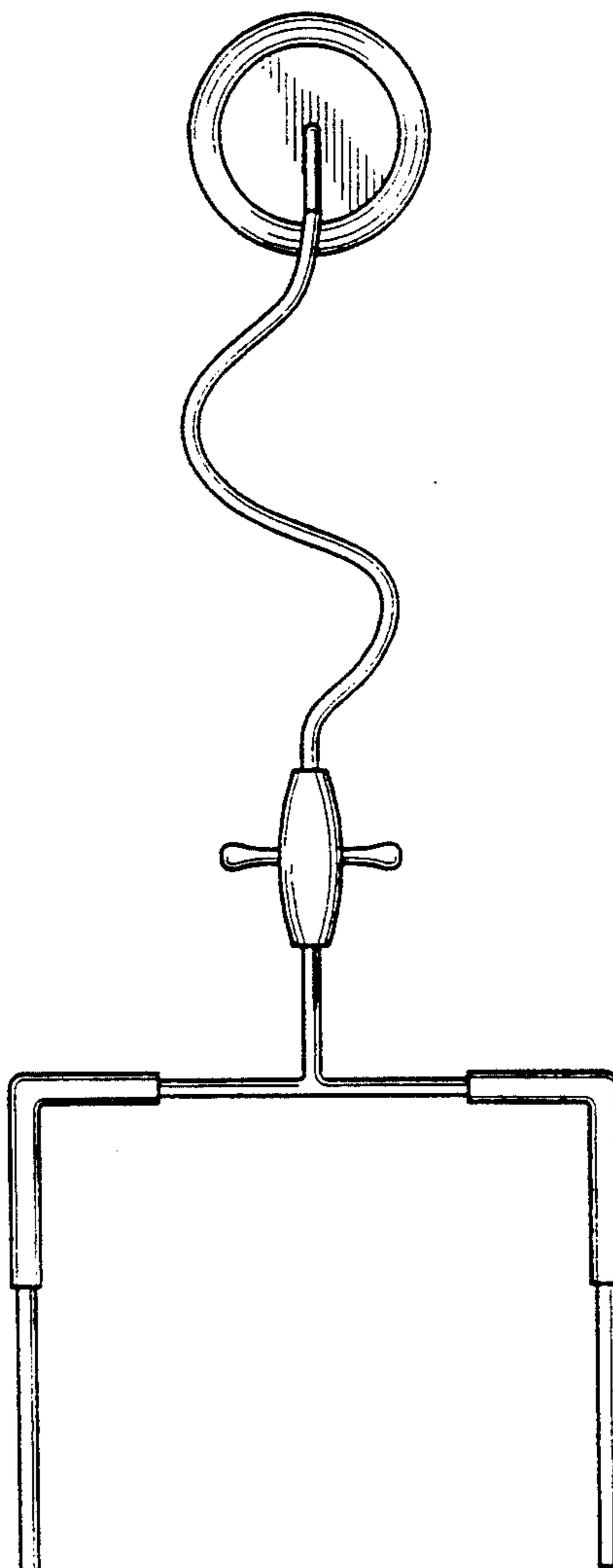

FIG. 7

