



US00D344915S

# United States Patent [19]

[11] Patent Number: **Des. 344,915**

Jarke

[45] Date of Patent: **\*\* Mar. 8, 1994**

[54] **COLLAPSED WHEELED SEAT**

[75] Inventor: **Joseph M. Jarke, Austin, Tex.**

[73] Assignee: **Jarke-Thorsen Products, Inc., Austin, Tex.**

[\*\*] Term: **14 Years**

[21] Appl. No.: **821,534**

[22] Filed: **Jan. 16, 1992**

[52] U.S. Cl. .... **D12/128; D12/131**

[58] Field of Search ..... **297/DIG. 4, 17; 280/643, 650; D12/128, 131**

4,025,088	5/1977	Rothschild .
4,045,051	8/1977	Igarishi .
4,164,354	8/1979	Rodaway .
4,369,987	1/1983	Witherell .
4,405,142	9/1983	Whetstine .
4,415,177	11/1983	Hale et al. .
4,527,829	7/1985	Fanslau et al. .
4,632,409	12/1986	Hall et al. .
4,831,689	5/1989	Lo .
4,974,870	12/1990	Jarke et al. .

**FOREIGN PATENT DOCUMENTS**

2302066	9/1976	France .
729551	5/1955	United Kingdom .
2161455	1/1986	United Kingdom .

[56]

**References Cited**

**U.S. PATENT DOCUMENTS**

D. 297,722	9/1988	Siwersson et al. ....	D12/131
D. 300,733	4/1989	Wagner .....	D12/131
630,427	11/1899	Turner .	
2,447,557	8/1948	Blaney .	
2,528,676	11/1950	Walters .	
2,532,863	12/1950	Taylor .	
2,589,372	3/1952	Hake .	
2,729,276	1/1956	Volney .	
2,966,204	12/1960	Caravias .	
3,544,157	12/1970	Muller .	
3,674,306	7/1972	Botney .	
3,765,718	10/1973	Chen .	
3,909,061	9/1975	Johnson .	
3,968,991	7/1976	Maclaren .	

*Primary Examiner*—Kay H. Chin  
*Attorney, Agent, or Firm*—Richard J. Smith

[57]

**CLAIM**

The ornamental design for a collapsed wheeled seat, as shown and described.

**DESCRIPTION**

FIG. 1 is a perspective view of a collapsed wheeled seat showing my new design; FIG. 2 is a top plan view thereof; FIG. 3 is a front elevational view thereof; FIG. 4 is a left side elevational view thereof; FIG. 5 is a right side elevational view thereof; FIG. 6 is a rear elevational view thereof; and, FIG. 7 is a bottom plan view thereof.

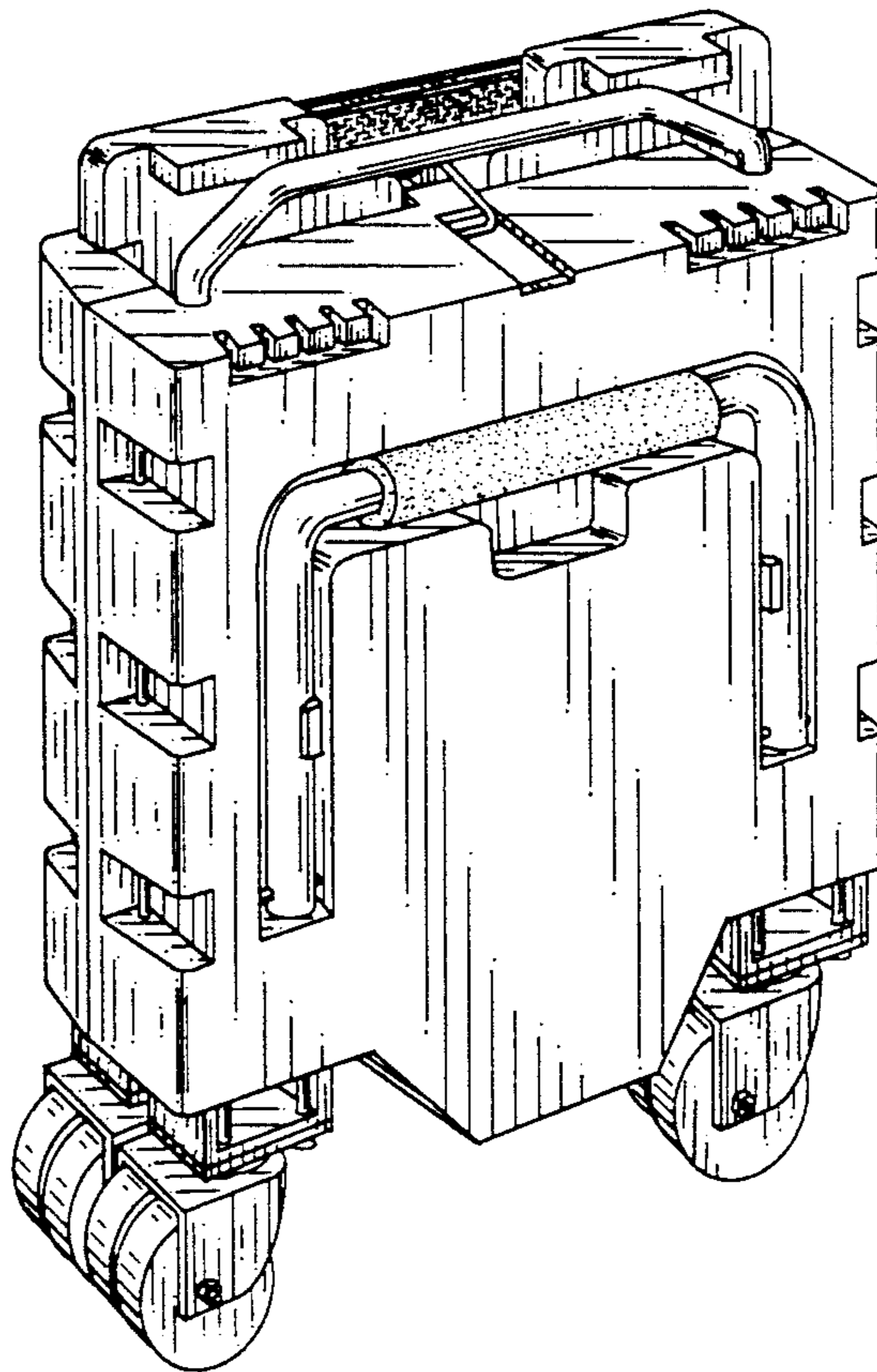

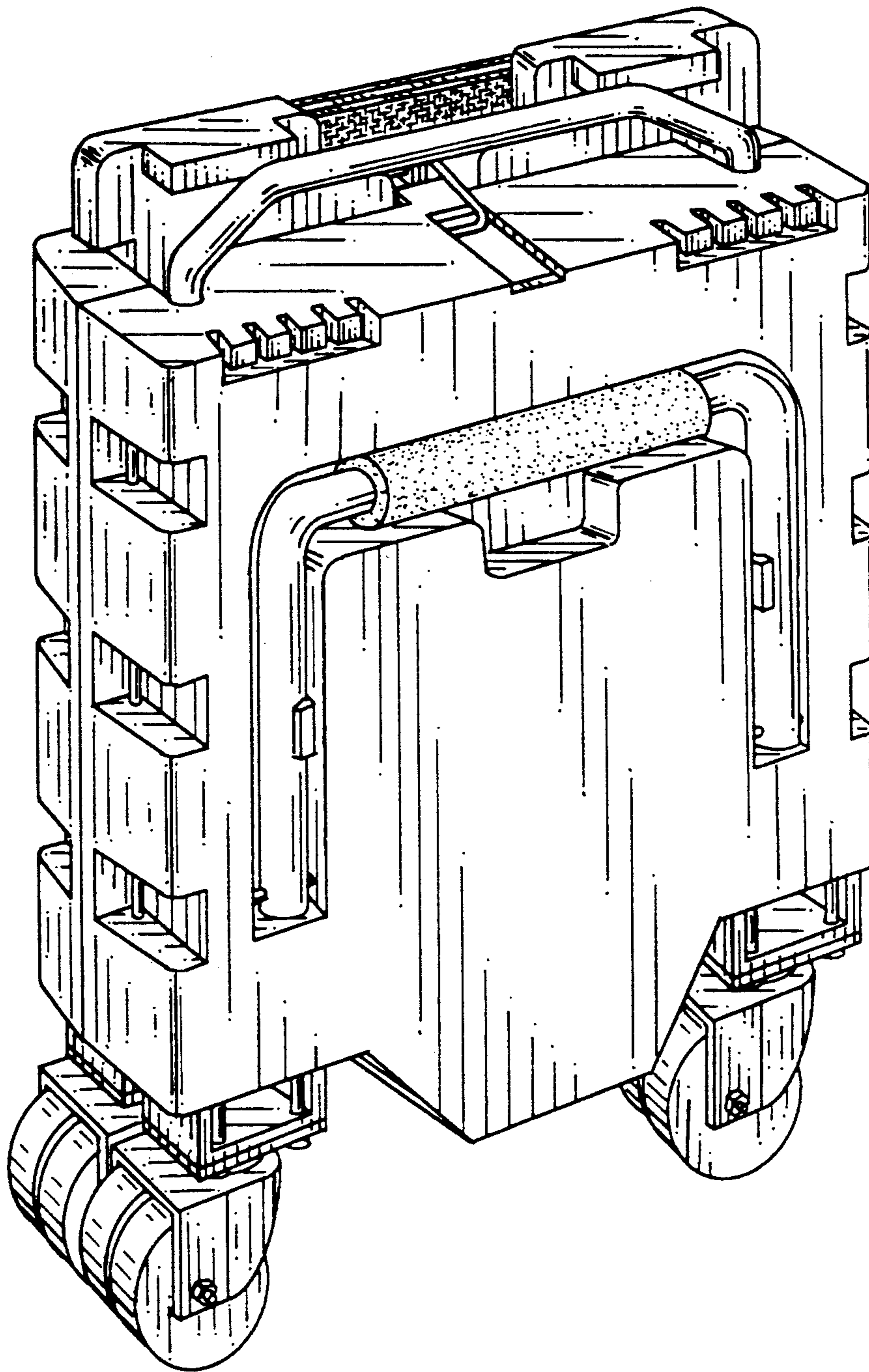

Fig. 1

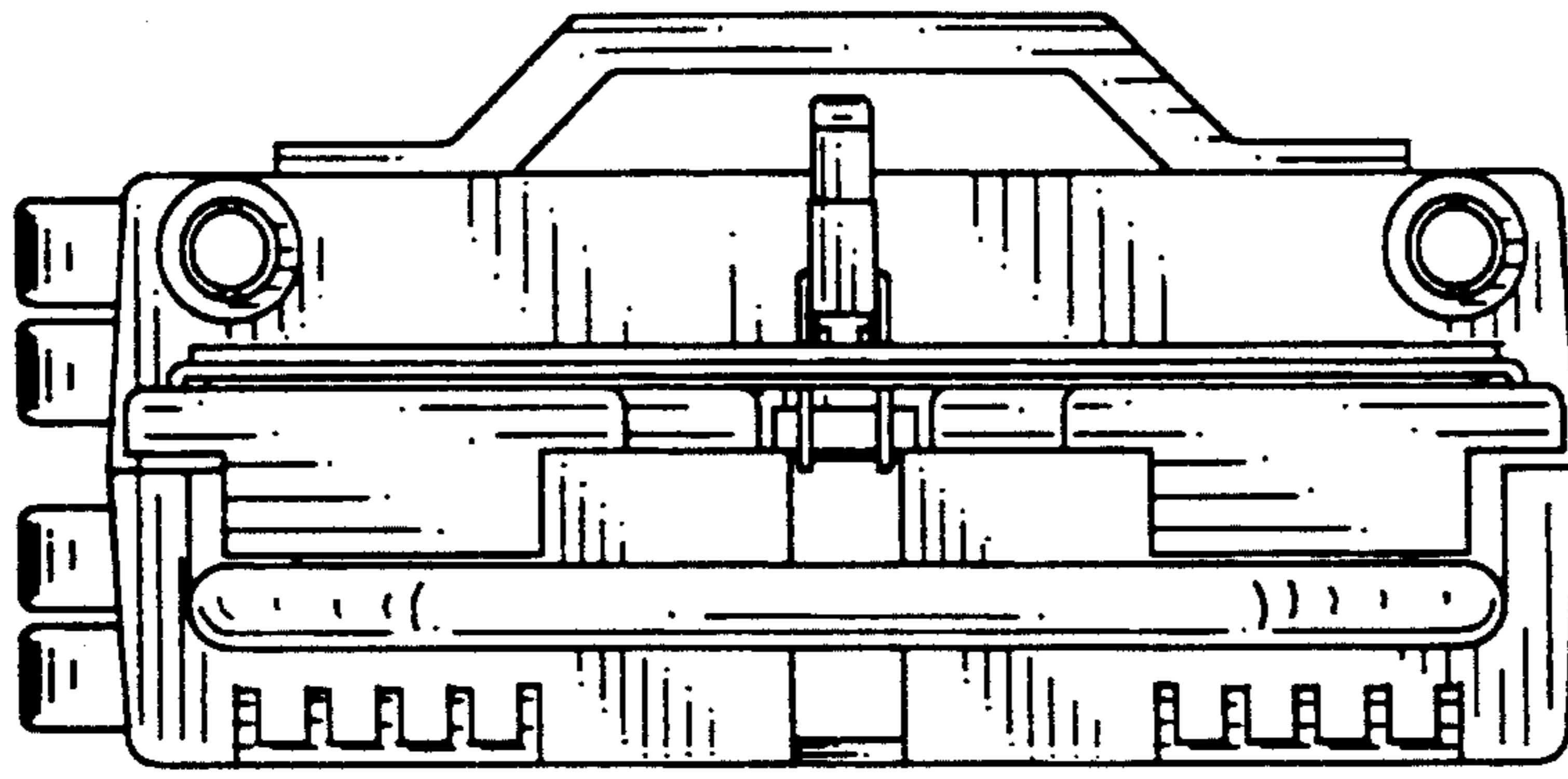

Fig. 2

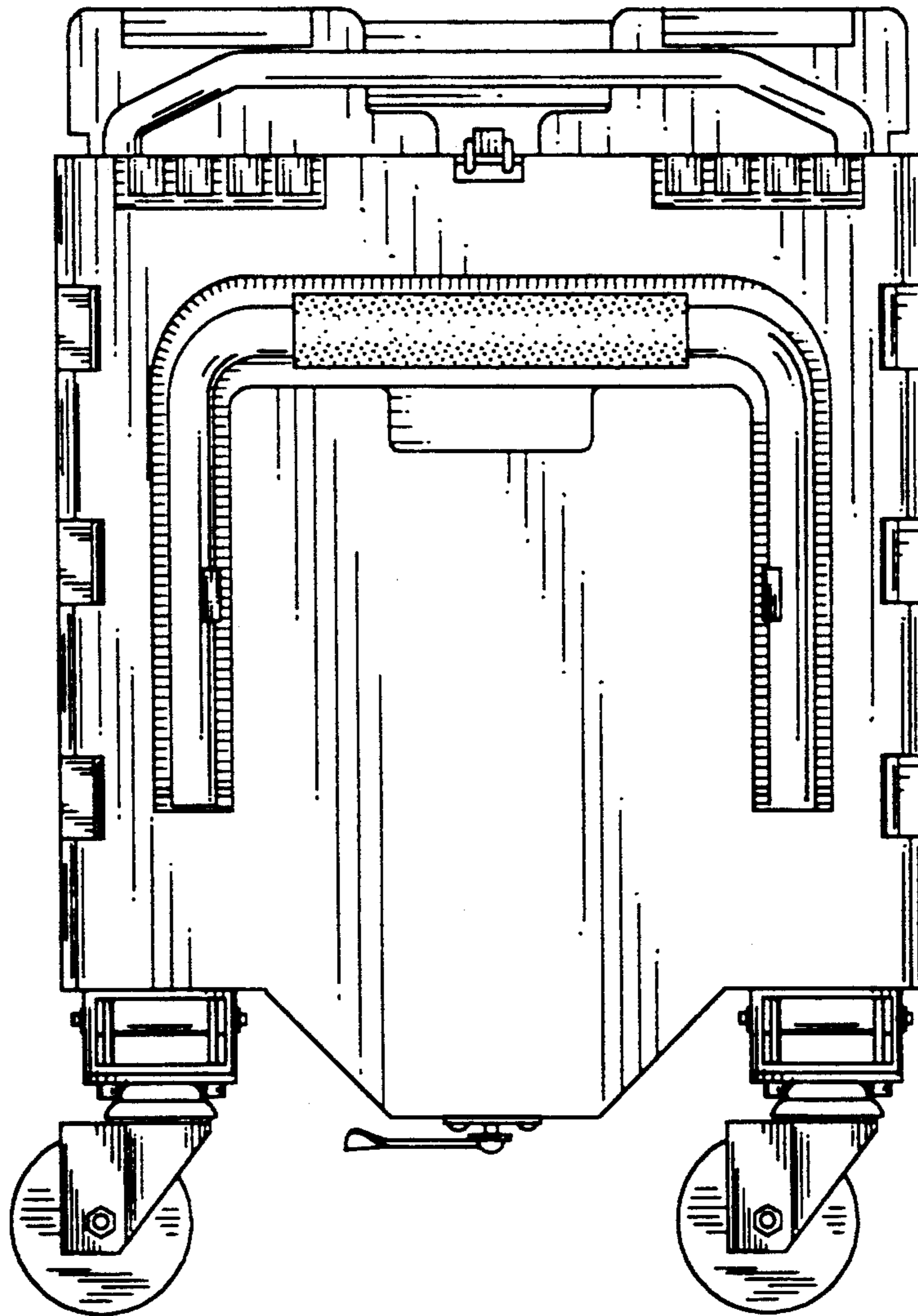

Fig. 3

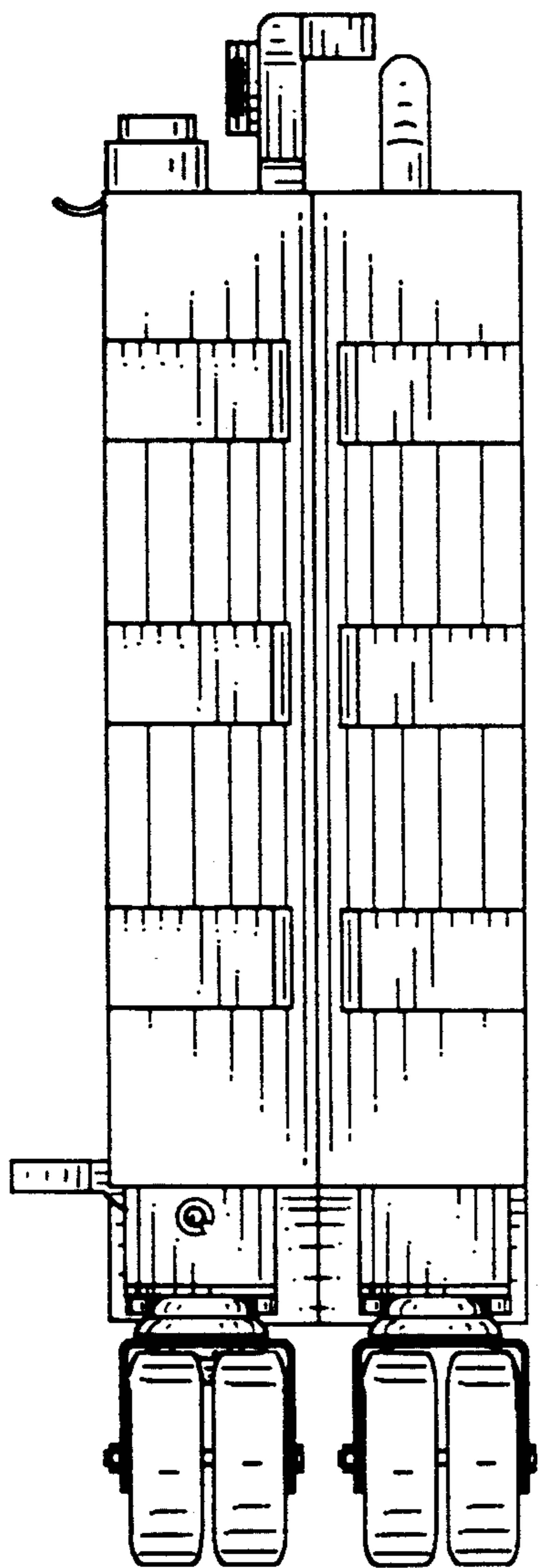

Fig. 4

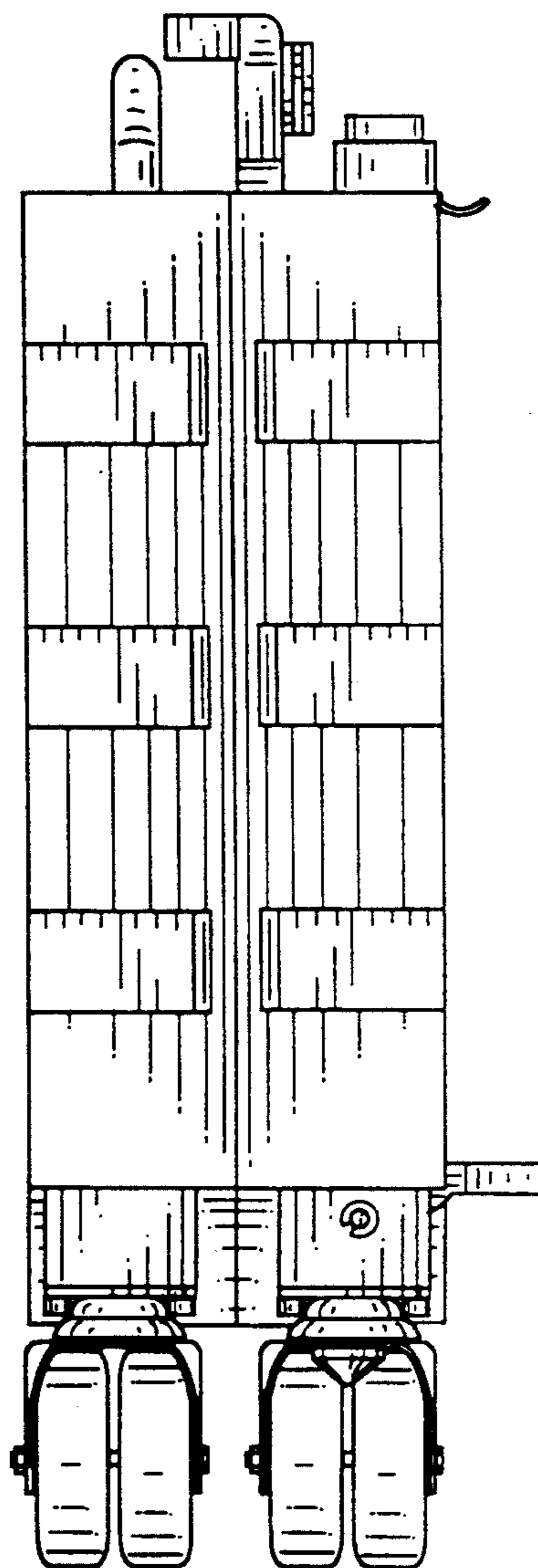

Fig. 5

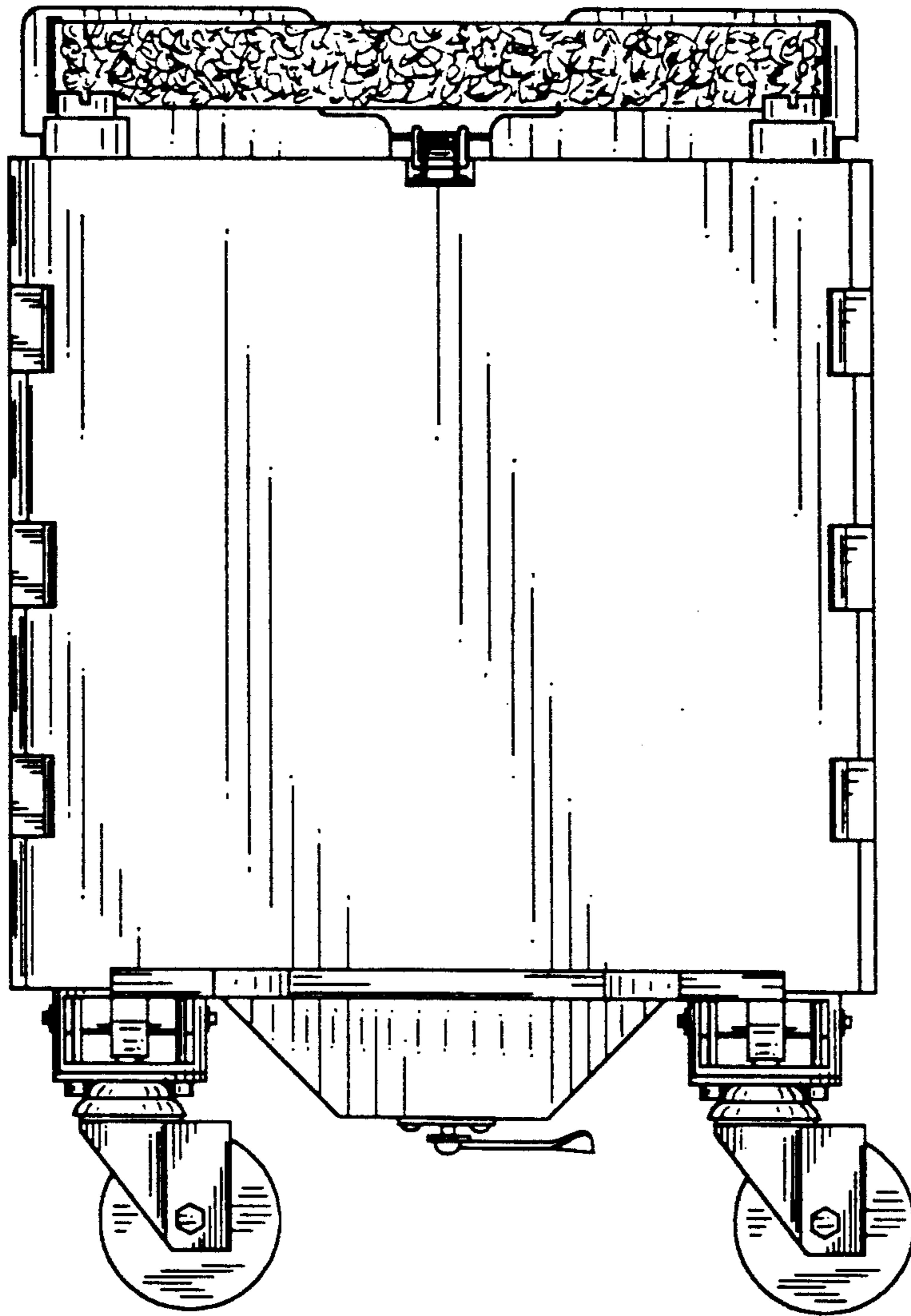

Fig. 6

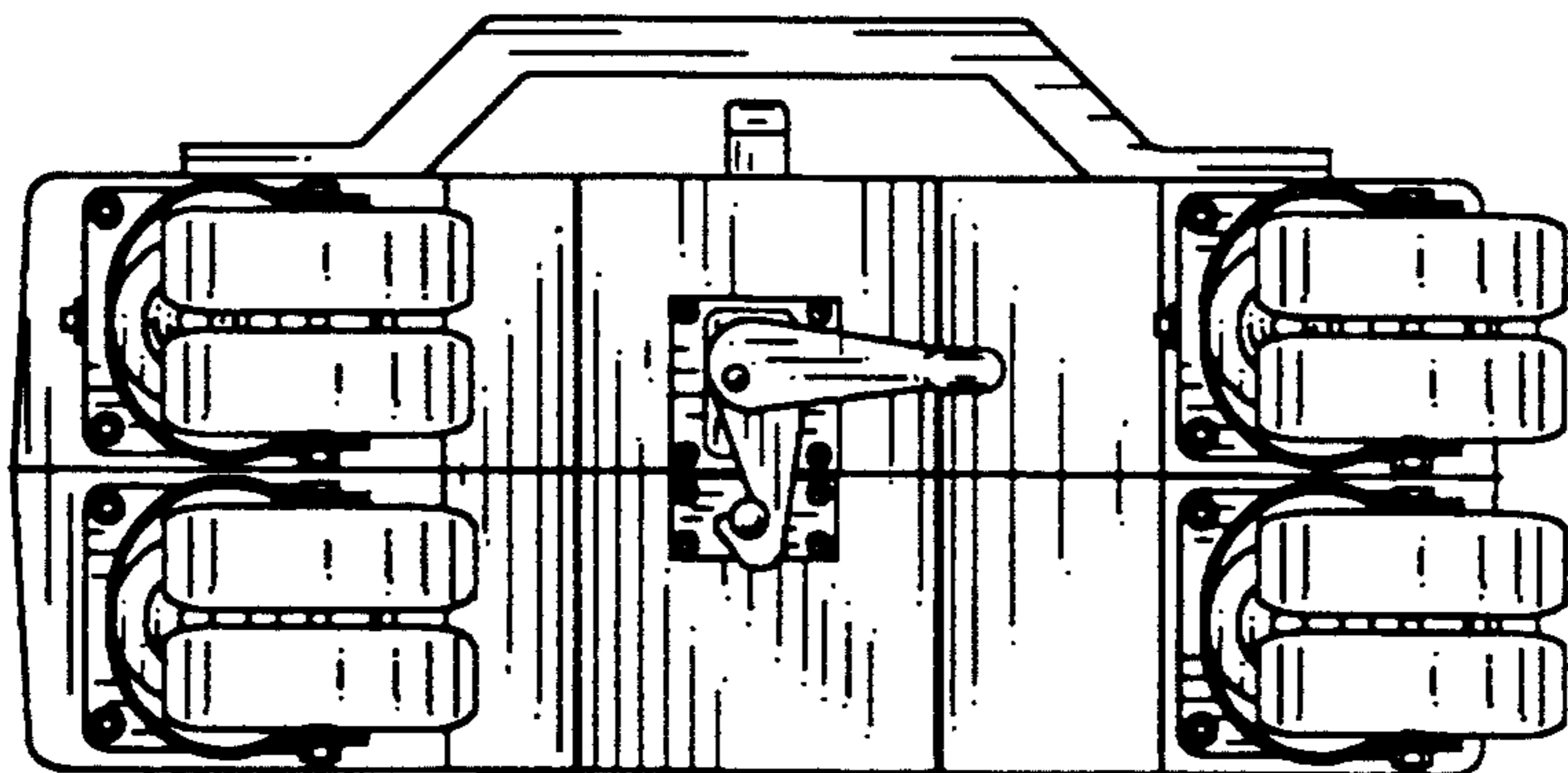

Fig. 7