



US00D344892S

# United States Patent [19]

[11] Patent Number: **Des. 344,892**

Robie et al.

[45] Date of Patent: **\*\* Mar. 8, 1994**

[54] **FOOD PACKAGE**

4,989,742 2/1991 Powell ..... 220/737 X  
5,170,908 12/1992 Austin ..... 220/737 X

[75] Inventors: **Steven C. Robie**, New Hope; **Arne H. Brauner**, Minnetonka; **Bradly A. Faber**, Falcon Heights, all of Minn.

*Primary Examiner*—Prabhakar G. Deshmukh  
*Attorney, Agent, or Firm*—John A. O’Toole; L. McRoy Lillehaugen

[73] Assignee: **General Mills, Inc.**, Minneapolis, Minn.

[57] **CLAIM**

[\*\*] Term: **14 Years**

The ornamental design for a food package, as shown and described.

[21] Appl. No.: **951**

**DESCRIPTION**

[22] Filed: **Oct. 30, 1992**

[52] U.S. Cl. .... **D9/431**

[58] Field of Search ..... D9/430, 431, 417, 414, D9/435, 447, 424, 425; 426/119, 120, 115; 220/737, 675, 700, 745, 556, 505, 502, 527, 528, 23.83, 23.4, 23.6; 206/216; 215/6, 10, 100 R

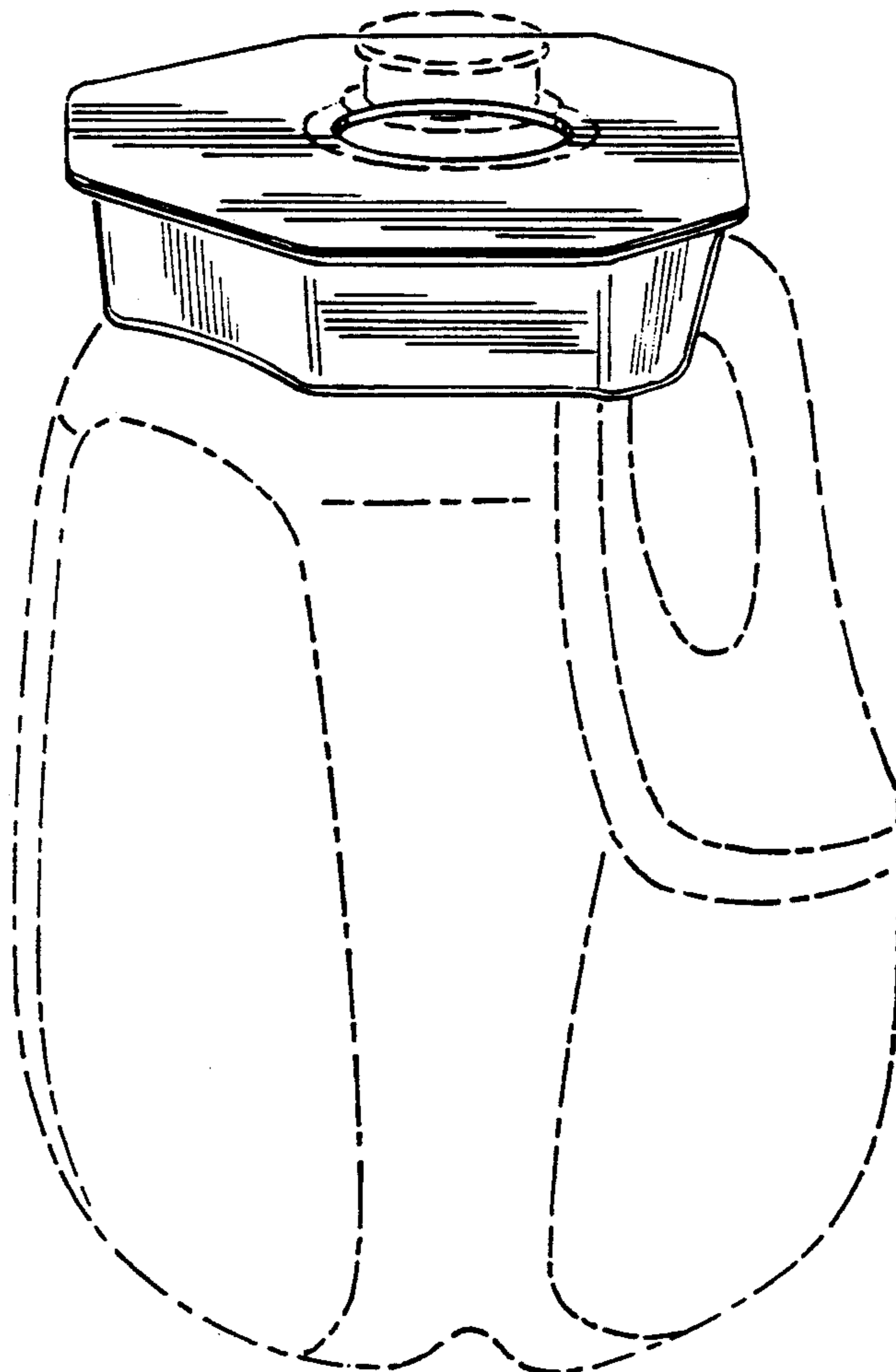
FIG. 1 is a perspective view of a food package illustrating our new design;  
FIG. 2 is a side elevational view of a food package, the opposite view is a mirror image thereof;  
FIG. 3 is a top plan view thereof;  
FIG. 4 is a side elevational view thereof;  
FIG. 5 is a front elevational view thereof;  
FIG. 6 is a rear elevational view thereof;  
FIG. 7 is a bottom plan view thereof; and,  
FIG. 8 is a cross sectional view taken along lines 8—8 of FIG. 7.

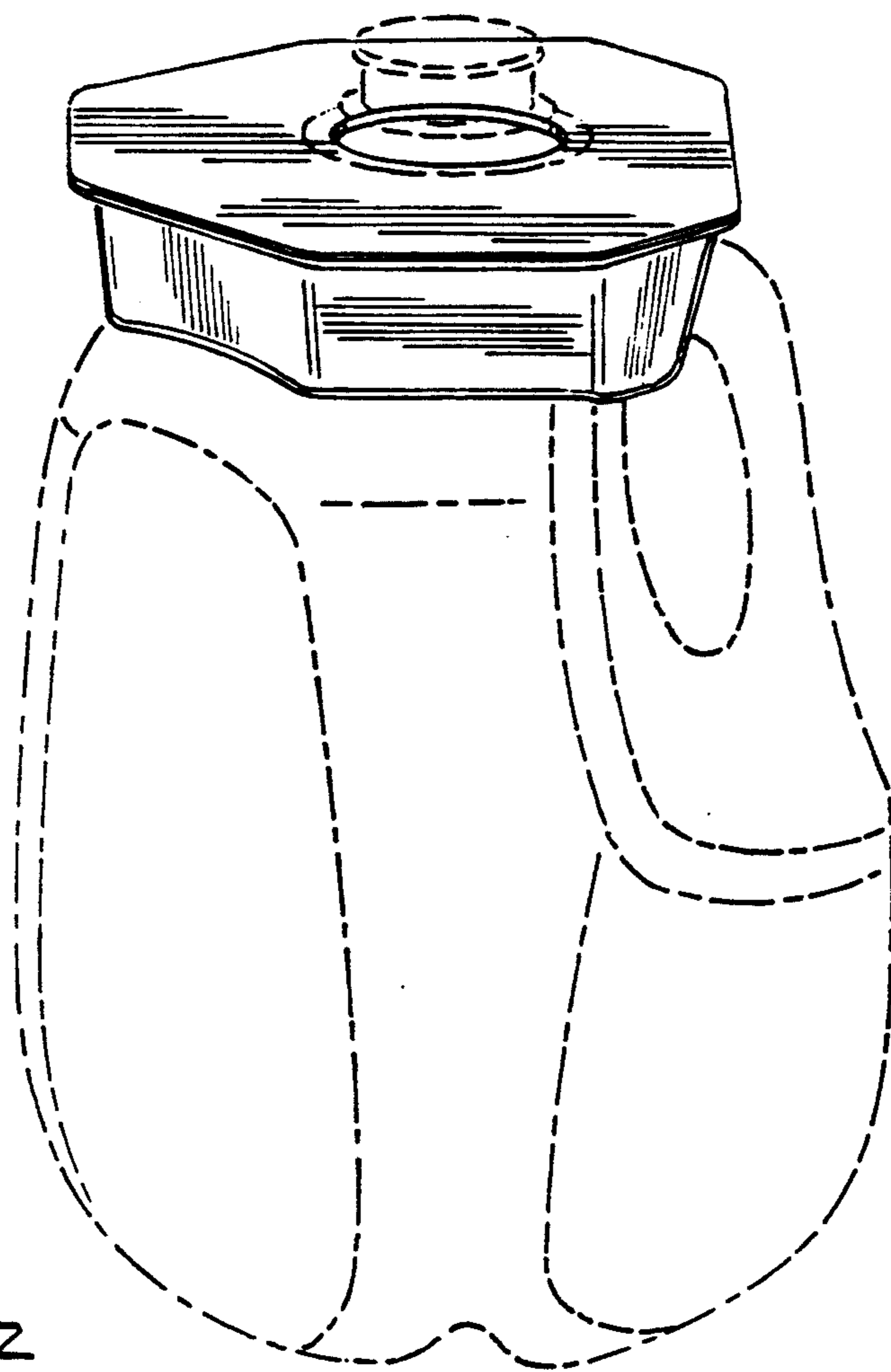
[56] **References Cited**

**U.S. PATENT DOCUMENTS**

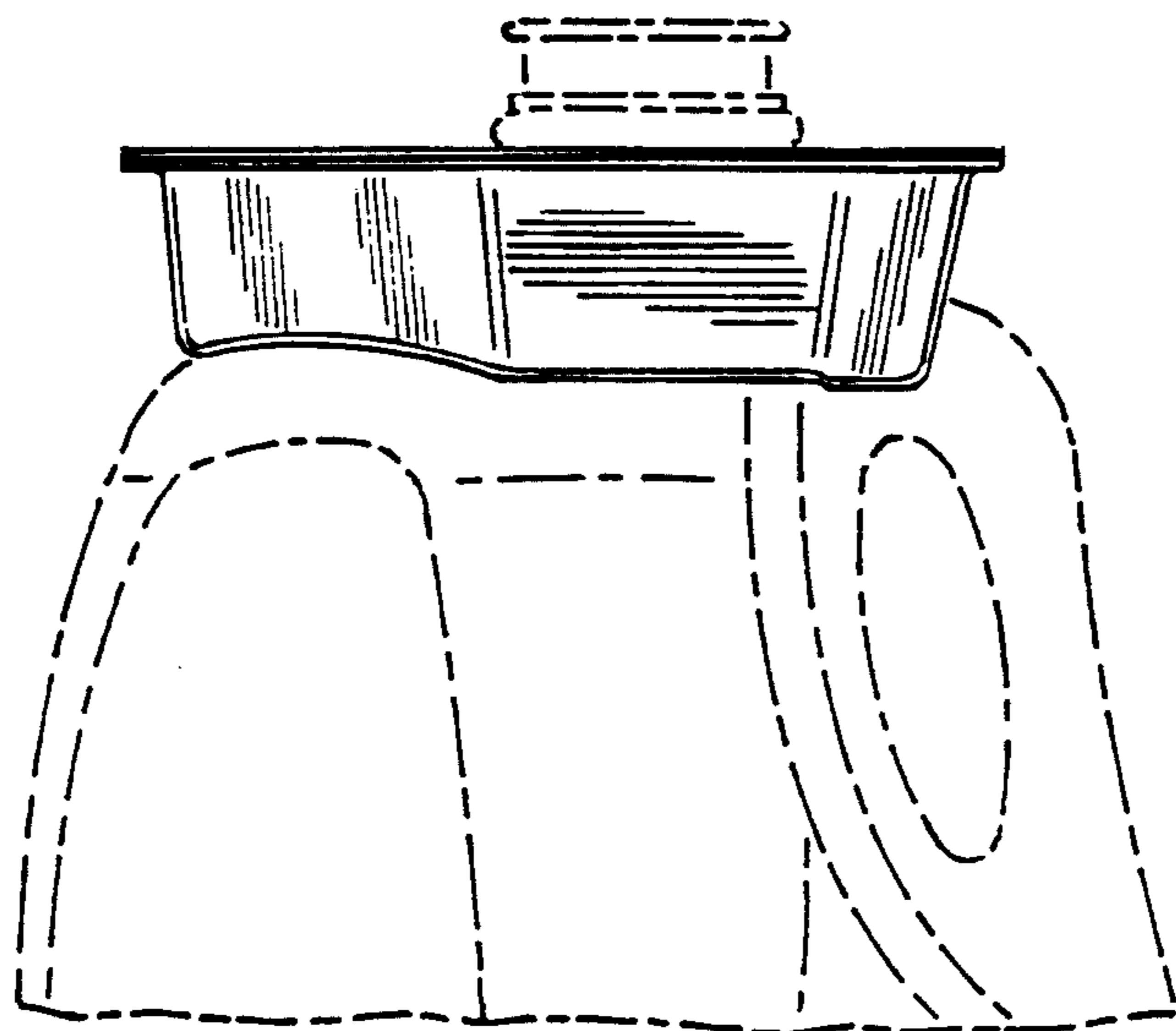
D. 280,383	9/1985	Tendick et al. ....	D9/425 X
3,413,128	11/1968	Steinbarth et al. ....	426/120 X
3,442,435	5/1969	Ludder et al. ....	426/120 X
4,844,243	7/1989	Stiles .....	426/120 X

The broken line showing of a container is for illustrative purpose only and forms no part of the claim.

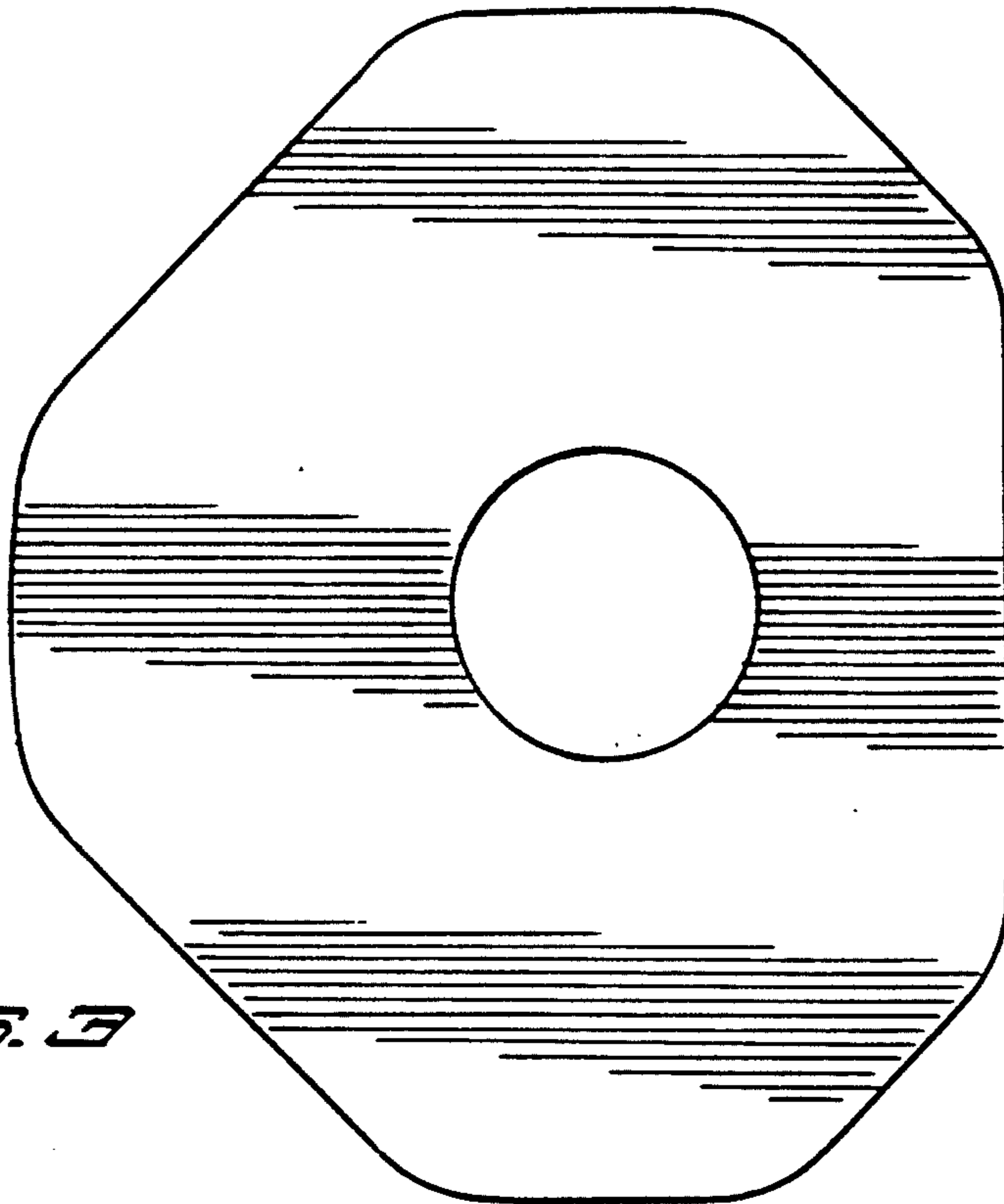




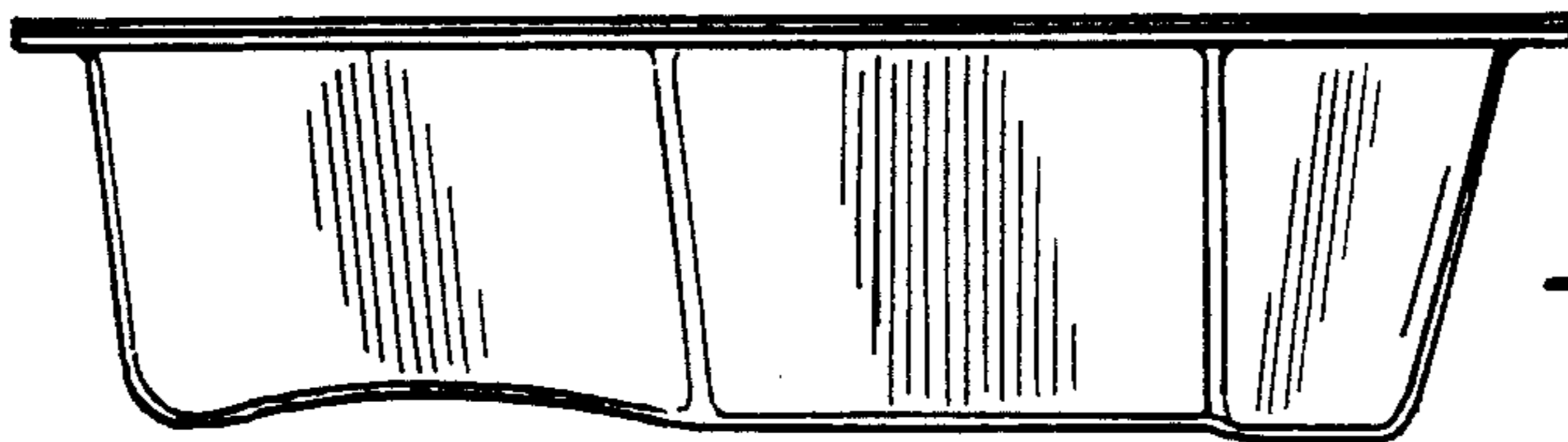
*FIG. 1*



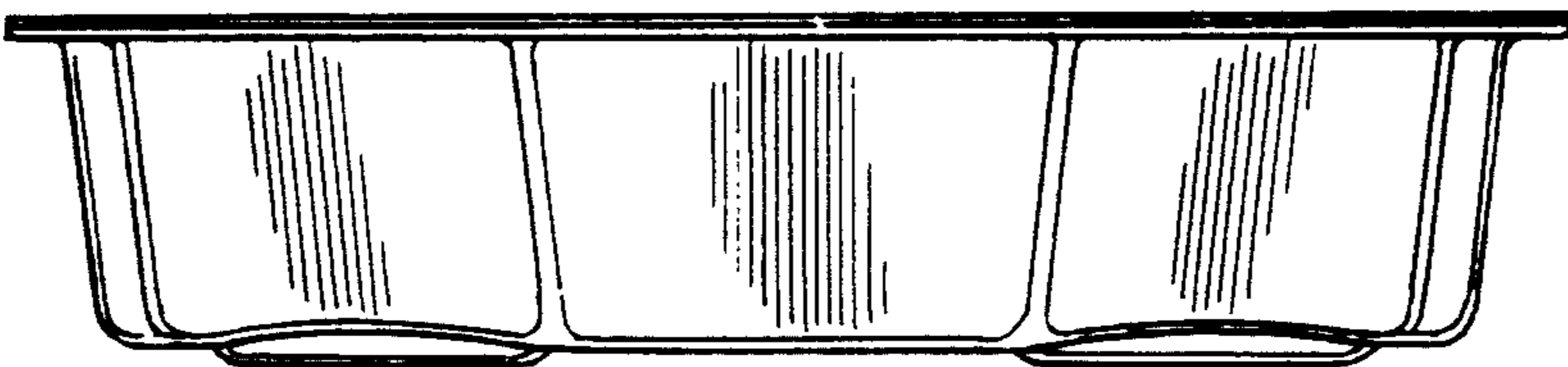
*FIG. 2*



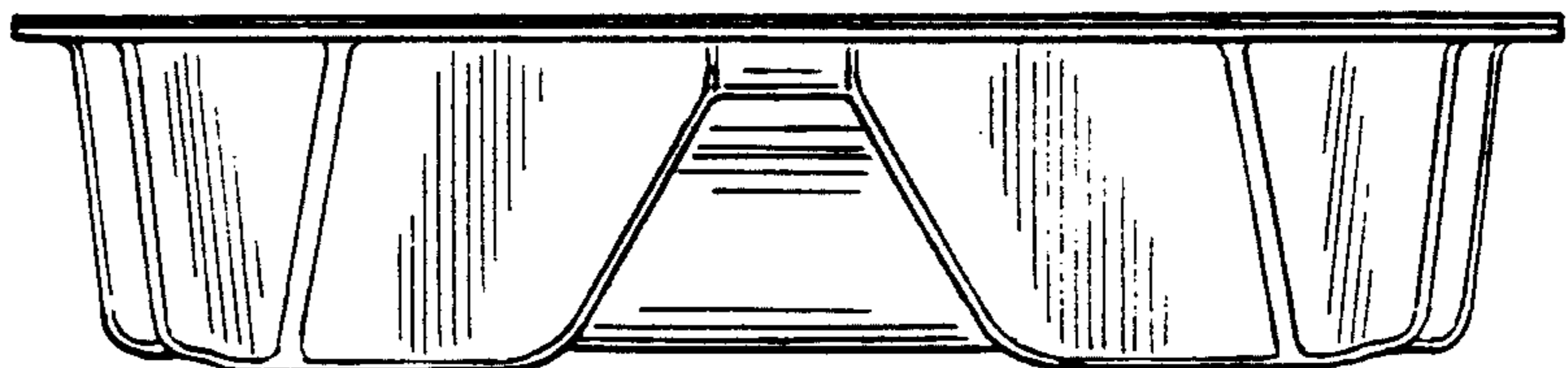
*FIG. 3*



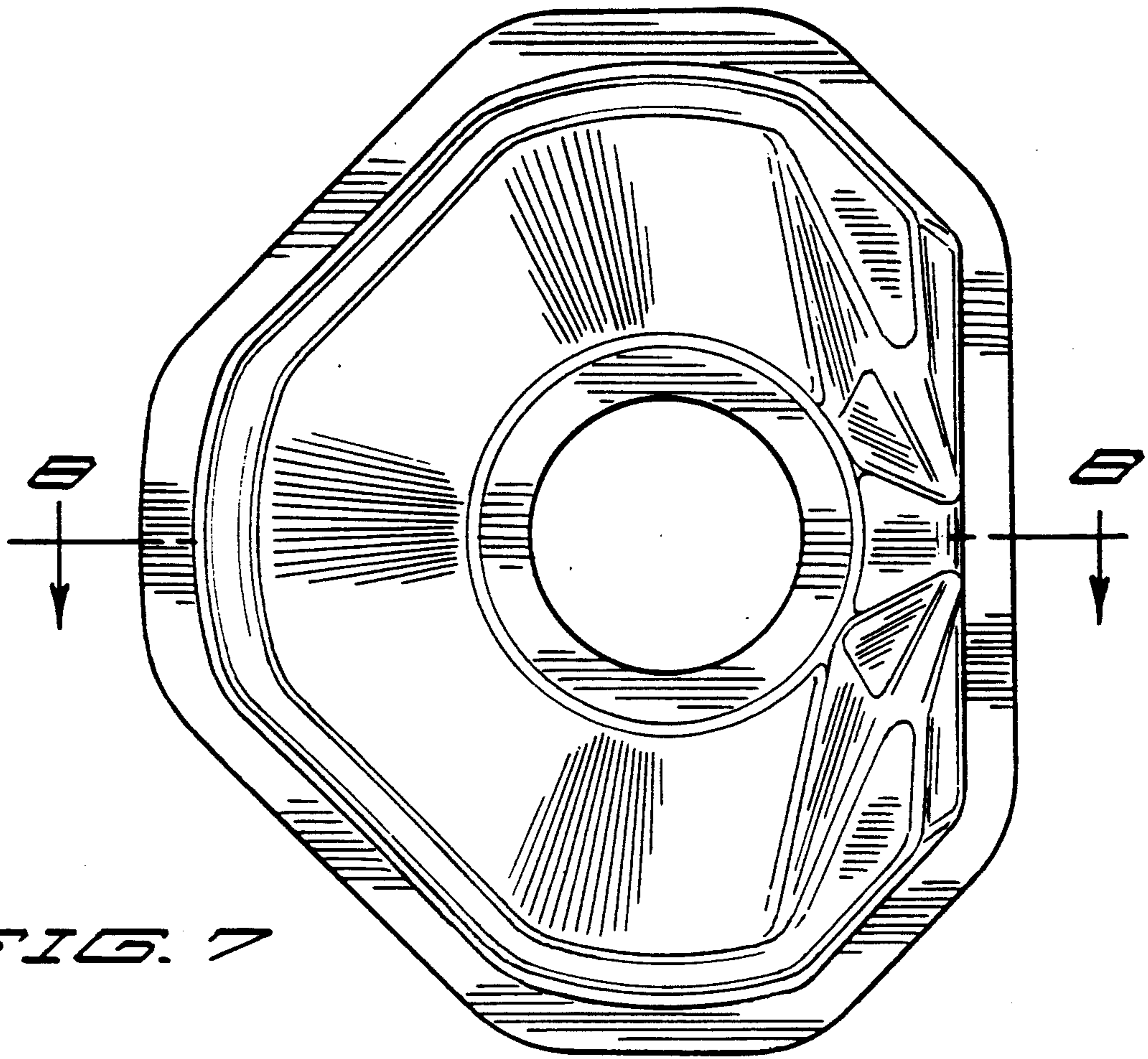
*FIG. 4*



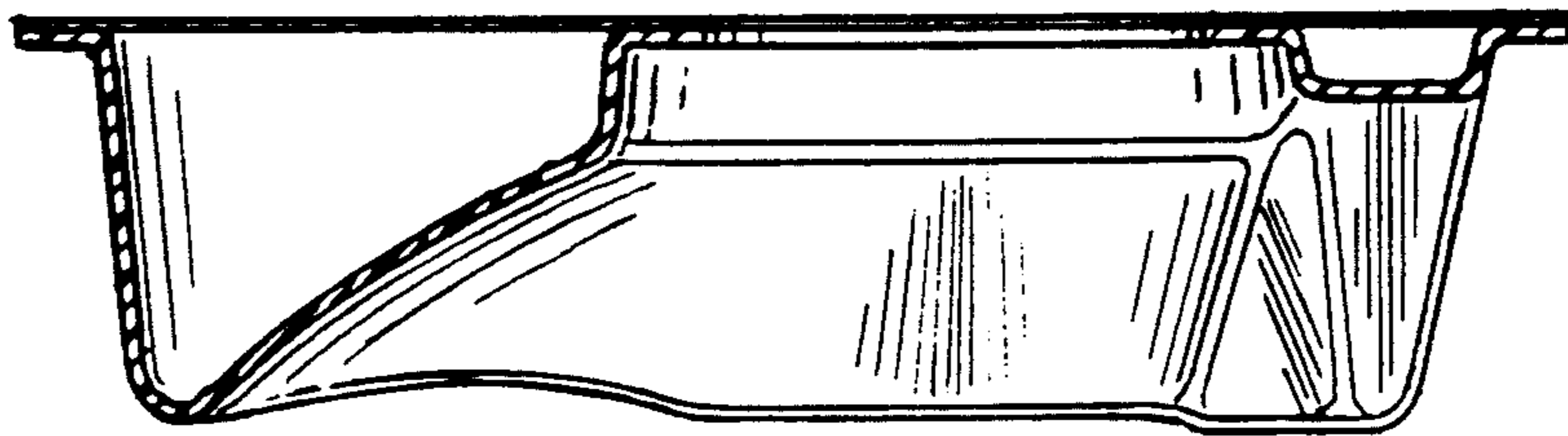
*FIG. 5*



*FIG. 6*



*FIG. 7*



*FIG. 8*