



US00D344890S

United States Patent [19]

Townes

[11] Patent Number: **Des. 344,890**

[45] Date of Patent: **** Mar. 8, 1994**

[54] **TRANSPARENT SHOE BOX**

[76] Inventor: **Lizzie B. Townes**, 720 Lenox Ave.
#15-G, New York, N.Y. 10039

[**] Term: **14 Years**

[21] Appl. No.: **846,423**

[22] Filed: **Mar. 6, 1992**

[52] U.S. Cl. **D9/418; D9/430**

[58] Field of Search **D9/418, 414, 430, 337,
D9/424; D2/265, 699; 206/278, 45.31, 45.34,
292, 293; 229/162, 925**

4,083,483 4/1978 Bayless 206/278 X
 4,244,508 1/1981 Schulman .
 4,676,371 6/1987 Byrne 206/45.34 X
 4,703,850 11/1987 Walker .
 4,819,795 4/1989 Swaney .

Primary Examiner—Prabhakar G. Deshmukh
Attorney, Agent, or Firm—Terry M. Gernstein

[57] CLAIM

The ornamental design for a transparent shoe box, as shown and described.

DESCRIPTION

FIG. 1 is perspective view of a transparent shoe box showing my new design;
 FIG. 2 is a front elevational view thereof;
 FIG. 3 is a rear elevational view thereof;
 FIG. 4 is a left side elevational view thereof;
 FIG. 5 is a right side elevational view thereof; and,
 FIG. 6 is a top plan view thereof; the bottom plan view being a mirror image thereof.

[56] **References Cited**

U.S. PATENT DOCUMENTS

D. 311,684	10/1990	Newell et al.	D9/418
104,853	6/1870	Kaufman	206/278
2,333,643	11/1943	Donnellan	206/278 X
2,592,059	4/1952	Nederostek	383/38 X
3,625,396	12/1971	Phipps	206/534 X

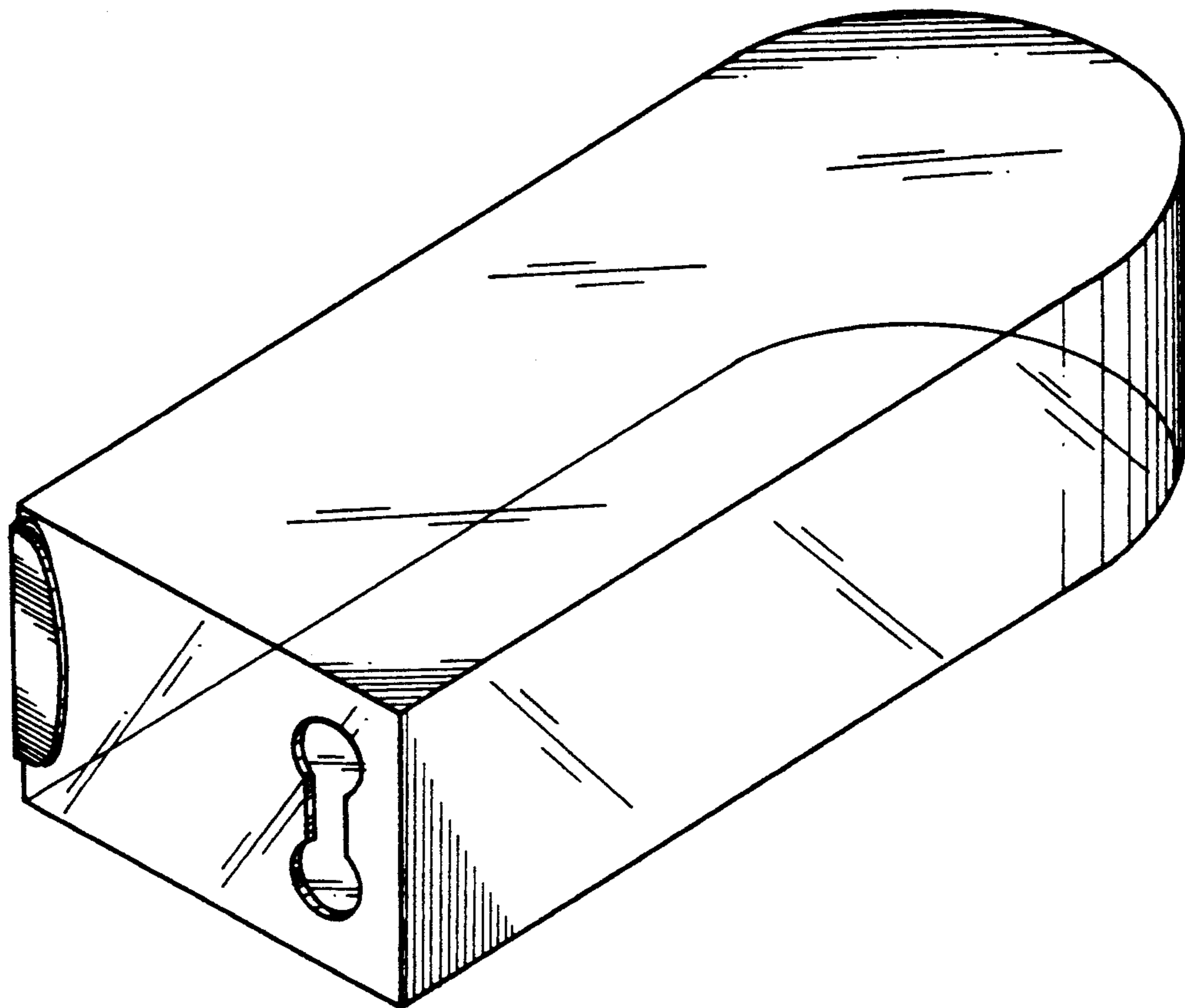

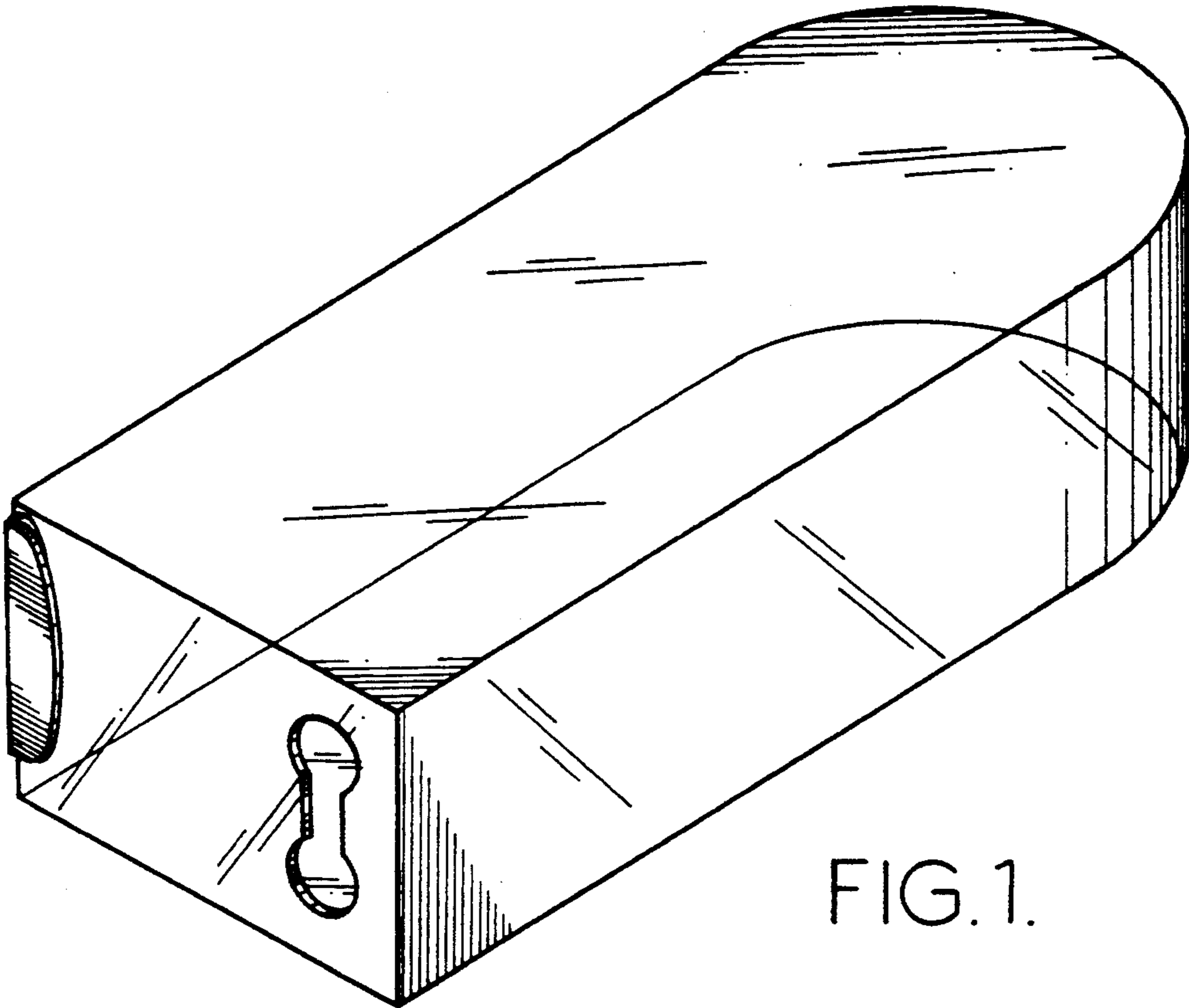

FIG. 1.

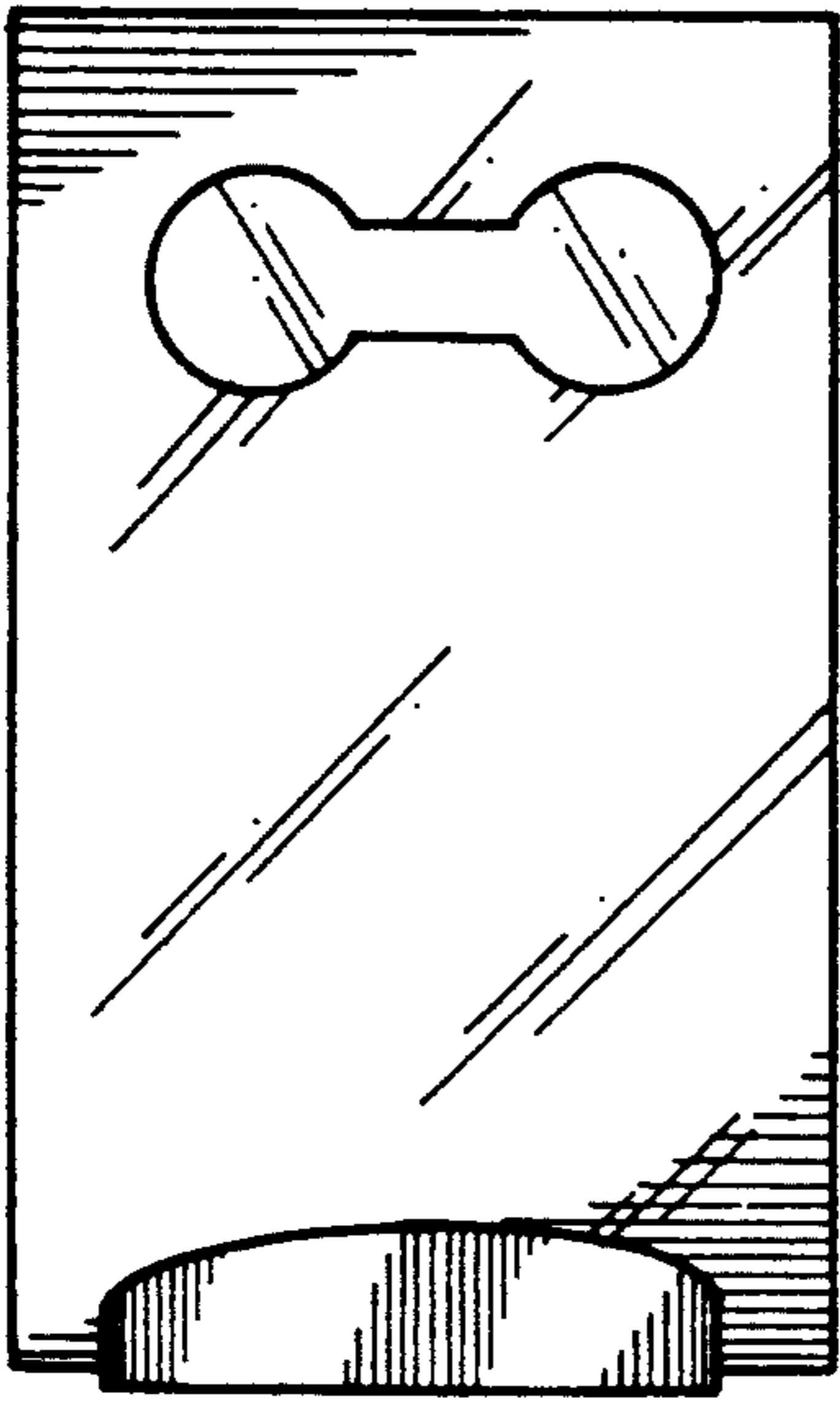

FIG. 2.

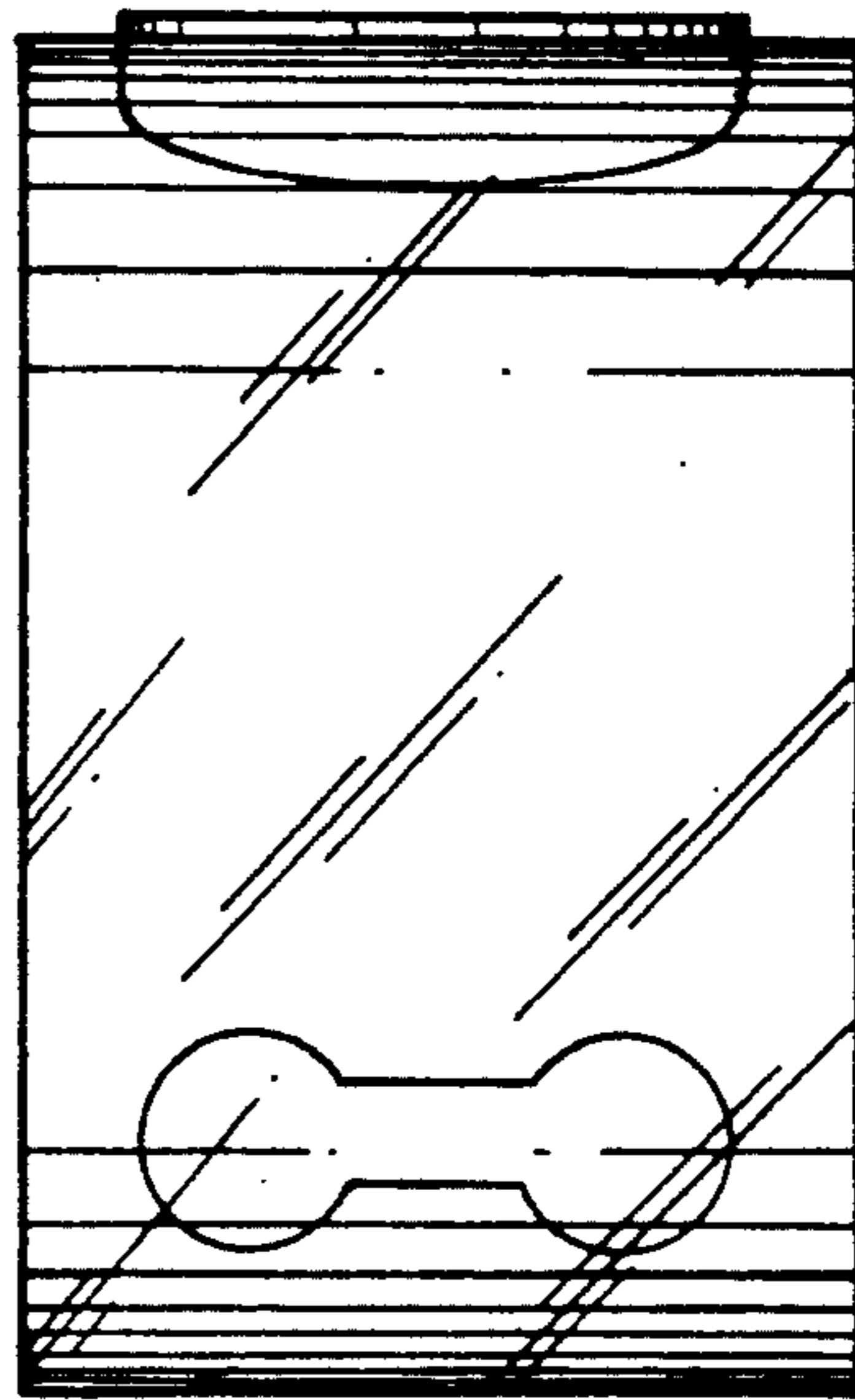

FIG. 3.

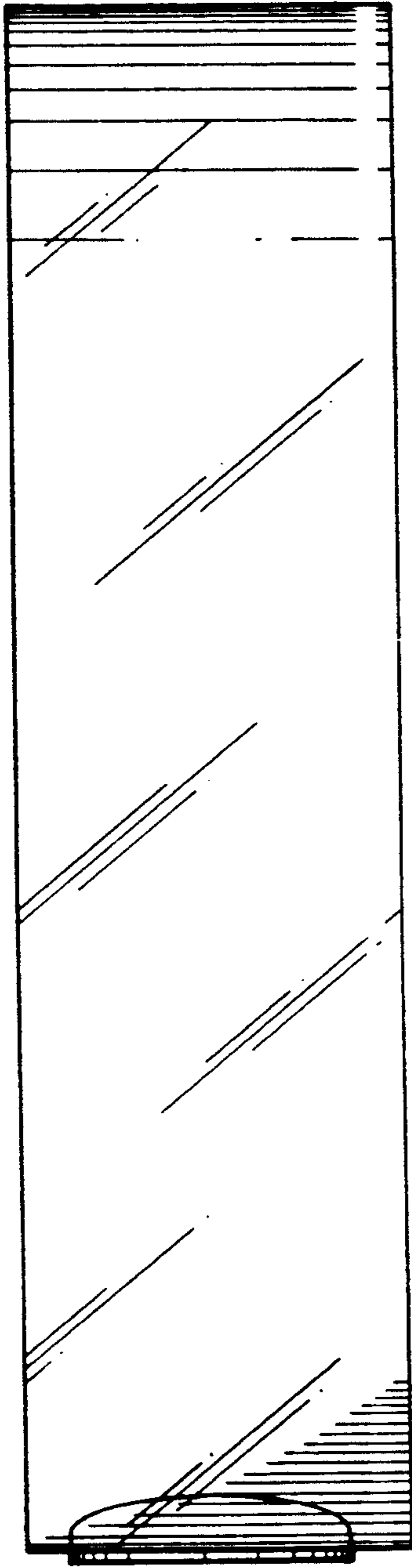

FIG. 4.

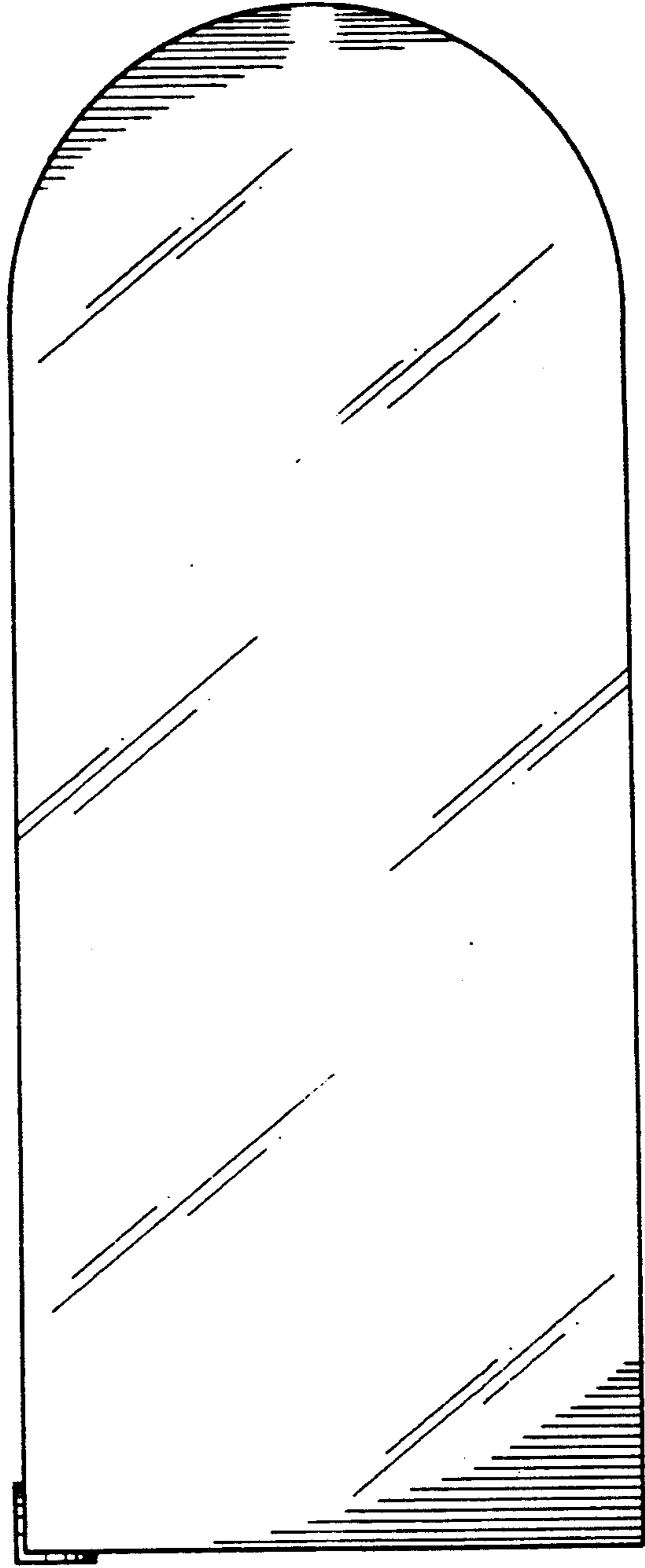

FIG. 6.

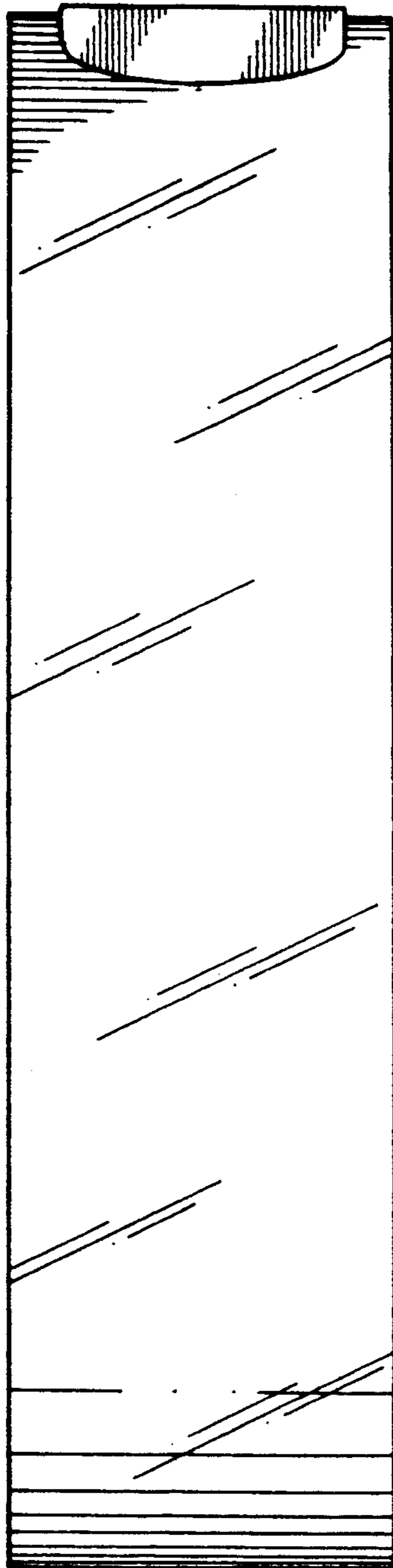

FIG. 5.