



US00D344778S

# United States Patent [19] Solheim

[11] Patent Number: **Des. 344,778**  
[45] Date of Patent: **\*\* Mar. 1, 1994**

[54] **GOLF CLUB HEAD**

[75] Inventor: **Karsten Solheim, Phoenix, Ariz.**

[73] Assignee: **Karsten Manufacturing Corporation, Phoenix, Ariz.**

[\*] Notice: The portion of the term of this patent subsequent to Jan. 26, 2007 has been disclaimed.

[\*\*] Term: **14 Years**

[21] Appl. No.: **3,556**

[22] Filed: **Jan. 12, 1993**

**Related U.S. Application Data**

[63] Continuation-in-part of Ser. No. 784,042, Oct. 28, 1991, Pat. No. Des. 332,812.

[52] U.S. Cl. .... **D21/220**

[58] Field of Search ..... **273/167-175; D21/220**

[56] **References Cited**

**U.S. PATENT DOCUMENTS**

D. 276,644	12/1984	Solheim	.....	D21/220
D. 303,132	8/1989	Muta	.....	D21/220
D. 332,812	1/1993	Solheim	.....	D21/220
4,512,577	4/1985	Solheim	.....	273/77 A
4,621,813	11/1986	Solheim	.....	273/77 A
4,802,672	2/1989	Long	.....	273/77 A
4,915,386	4/1990	Antonious	.....	273/167 F
5,026,056	6/1991	McNally et al.	.....	273/77 A

*Primary Examiner*—Melvin B. Feifer  
*Attorney, Agent, or Firm*—Darrell F. Marquette;  
Herbert E. Haynes, Jr.

[57] **CLAIM**

The ornamental design for golf club head, as shown and described.

**DESCRIPTION**

FIG. 1 is a perspective view of a 2-iron golf club head which embodies my new design;  
FIG. 2 is a toe end elevational view of the golf club head shown in FIG. 1;

FIG. 3 is a heel end elevational view of the golf club head shown in FIG. 1;  
FIG. 4 is a top plan view of the golf club head shown in FIG. 1;  
FIG. 5 is a bottom view of the golf club head shown in FIG. 1;  
FIG. 6 is a front elevational view of the golf club head shown in FIG. 1;  
FIG. 7 is a rear elevational view of the golf club head shown in FIG. 1;  
FIG. 8 is a perspective view of a 4-iron golf club head which embodies my new design;  
FIG. 9 is a toe end elevational view of the golf club head shown in FIG. 8;  
FIG. 10 is a heel end elevational view of the golf club head shown in FIG. 8;  
FIG. 11 is a top plan view of the golf club shown in FIG. 8;  
FIG. 12 is a bottom view of the golf club head shown in FIG. 8;  
FIG. 13 is a front elevational view of the golf club head shown in FIG. 8;  
FIG. 14 is a rear elevational view of the golf club head shown in FIG. 8;  
FIG. 15 is a perspective view of a 5-iron golf club head which embodies my new design;  
FIG. 16 is a toe end elevational view of the golf club head shown in FIG. 15;  
FIG. 17 is a heel end elevational view of the golf club head shown in FIG. 15;  
FIG. 18 is a top plan view of the golf club head shown in FIG. 15;  
FIG. 19 is a bottom view of the golf club head shown in FIG. 15;  
FIG. 20 is a front elevational view of the golf club head shown in FIG. 15;  
FIG. 21 is a rear elevational view of the golf club head shown in FIG. 15;  
FIG. 22 is a perspective view of a 7-iron golf club head which embodies my new design;  
FIG. 23 is a toe end elevational view of the golf club head shown in FIG. 22;  
FIG. 24 is a heel end elevational view of the golf club head shown in FIG. 22;  
FIG. 25 is a top plan view of the golf club head shown in FIG. 22;

(Description continued on next page.)

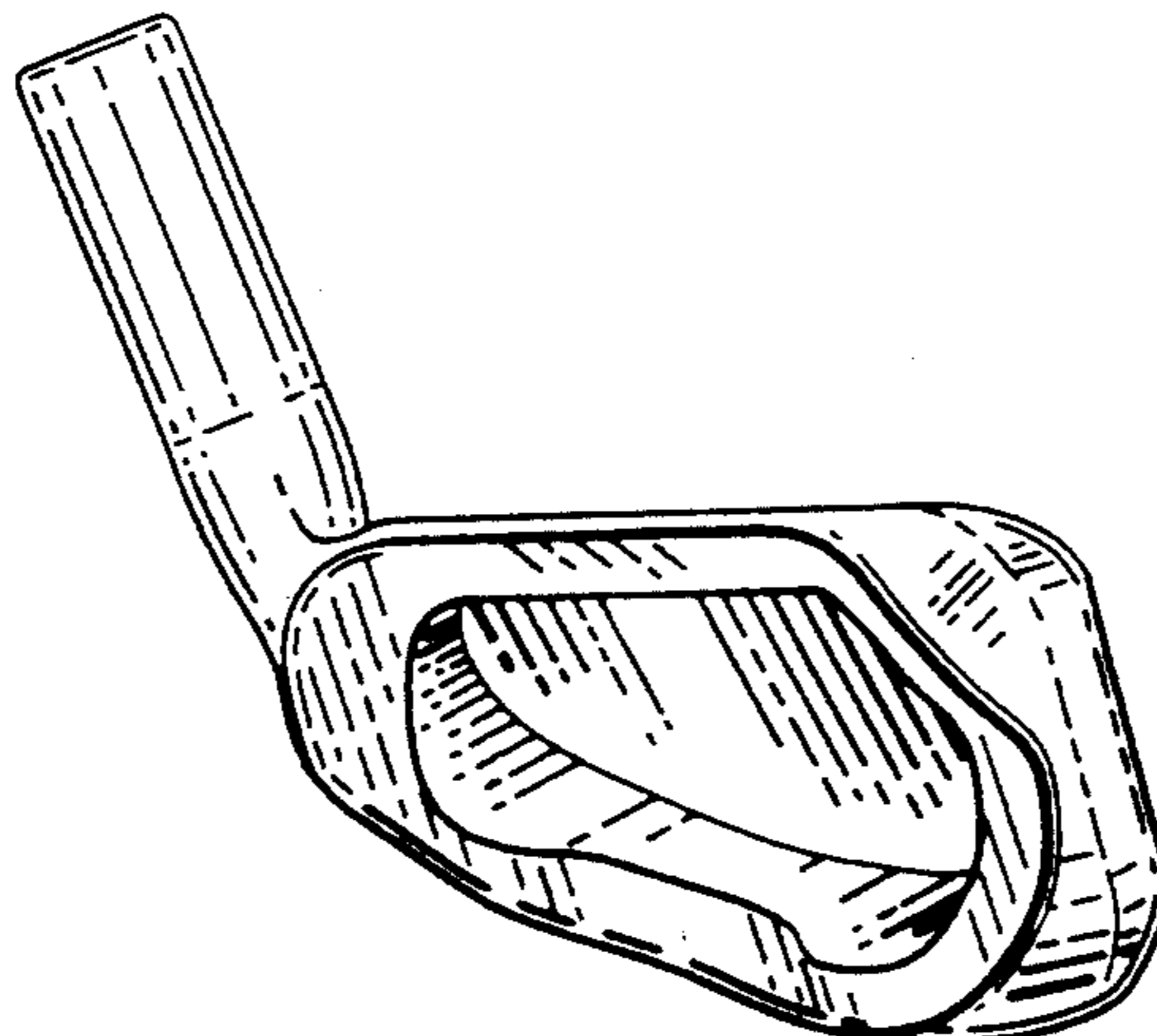

FIG. 26 is a bottom view of the golf club head shown in FIG. 22;

FIG. 27 is a front elevational view of the golf club head shown in FIG. 22;

FIG. 28 is a rear elevational view of the golf club head shown in FIG. 22;

FIG. 29 is a perspective view of an 8-iron golf club head which embodies my new design;

FIG. 30 is a toe end elevational view of the golf club head shown in FIG. 29;

FIG. 31 is a heel end elevational view of the golf club head shown in FIG. 29;

FIG. 32 is a top plan view of the golf club head shown in FIG. 29;

FIG. 33 is a bottom view of the golf club head shown in FIG. 29;

FIG. 34 is a front elevational view of the golf club head shown in FIG. 29;

FIG. 35 is a rear elevational view of the golf club head shown in FIG. 29;

FIG. 36 is a perspective view of a pitching wedge iron golf club head which embodies my new design;

FIG. 37 is a toe end elevational view of the golf club head shown in FIG. 36;

FIG. 38 is a heel end elevational view of the golf club head shown in FIG. 36;

FIG. 39 is a top plan view of the golf club head shown in FIG. 36;

FIG. 40 is a bottom view of the golf club head shown in FIG. 36;

FIG. 41 is a front elevational view of the golf club head shown in FIG. 36;

FIG. 42 is a rear elevational view of the golf club head shown in FIG. 36;

FIG. 43 is a perspective view of a lob wedge iron golf club head which embodies my new design;

FIG. 44 is a toe end elevational view of the golf club head shown in FIG. 43;

FIG. 45 is a heel end elevational view of the golf club head shown in FIG. 43;

FIG. 46 is a top plan view of the golf club head shown in FIG. 43;

FIG. 47 is a bottom view of the golf club head shown in FIG. 43;

FIG. 48 is a front elevational view of the golf club head shown in FIG. 43; and,

FIG. 49 is a rear elevational view of the golf club head shown in FIG. 43.

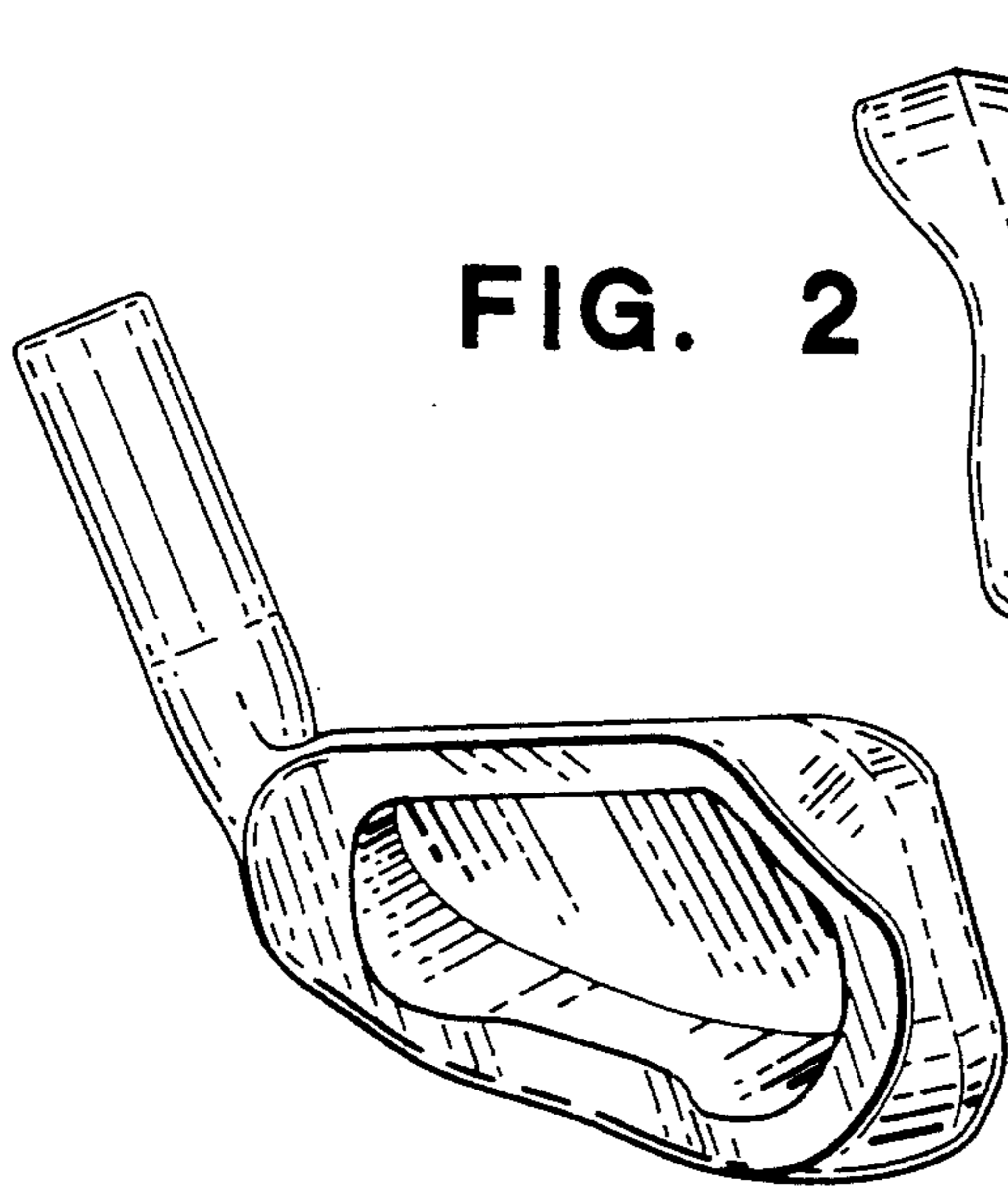

FIG. 1

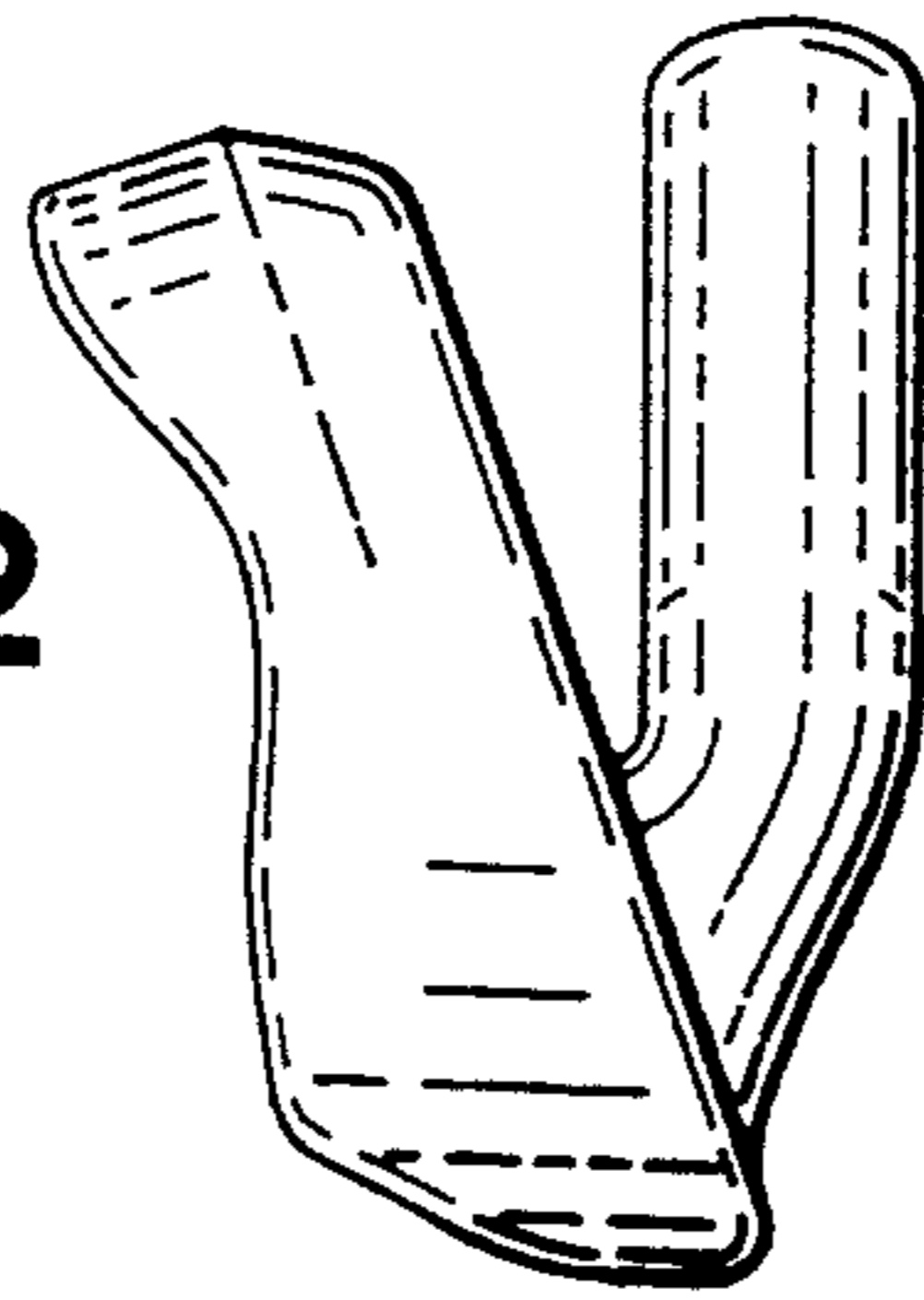

FIG. 2

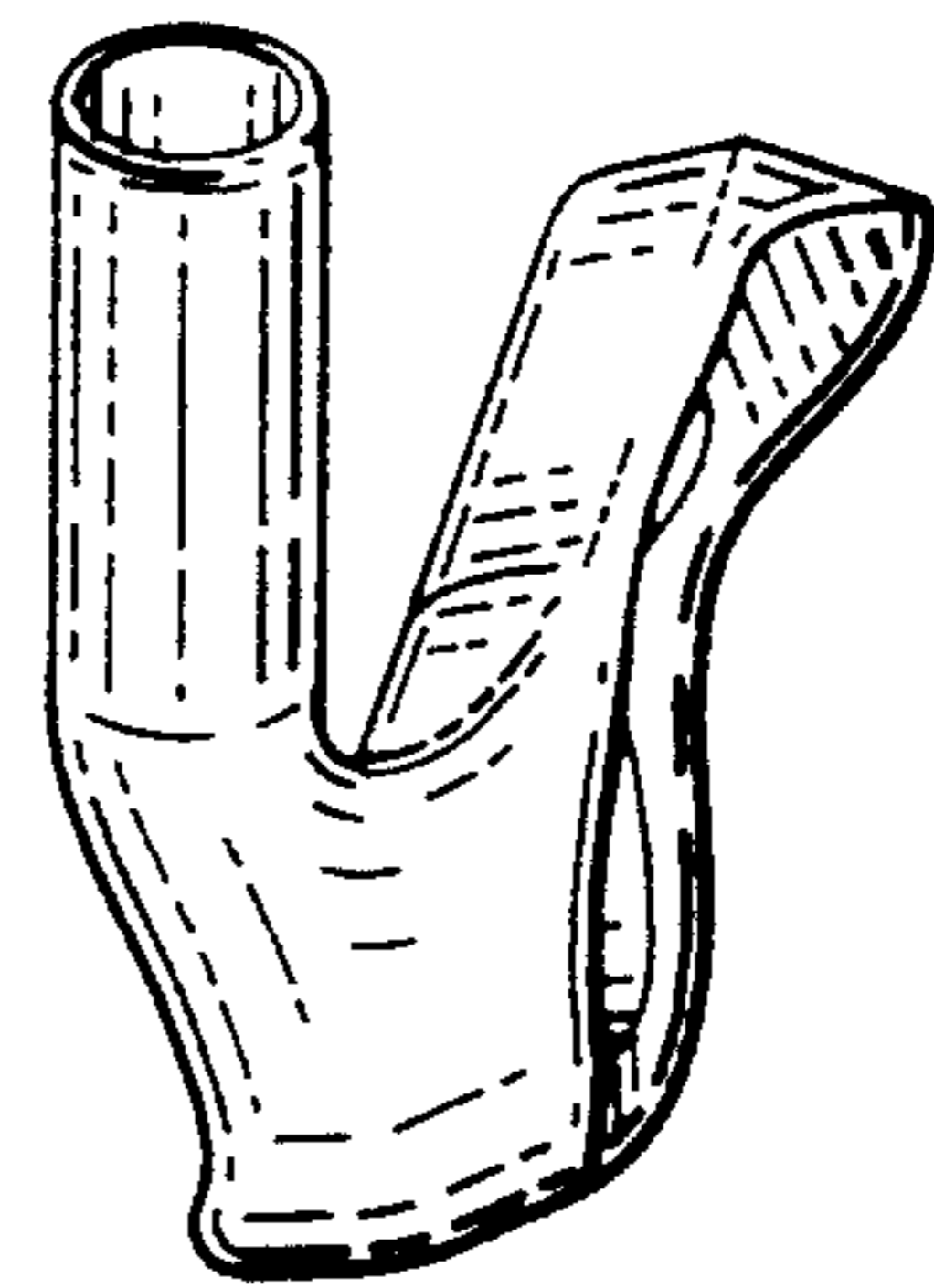

FIG. 3

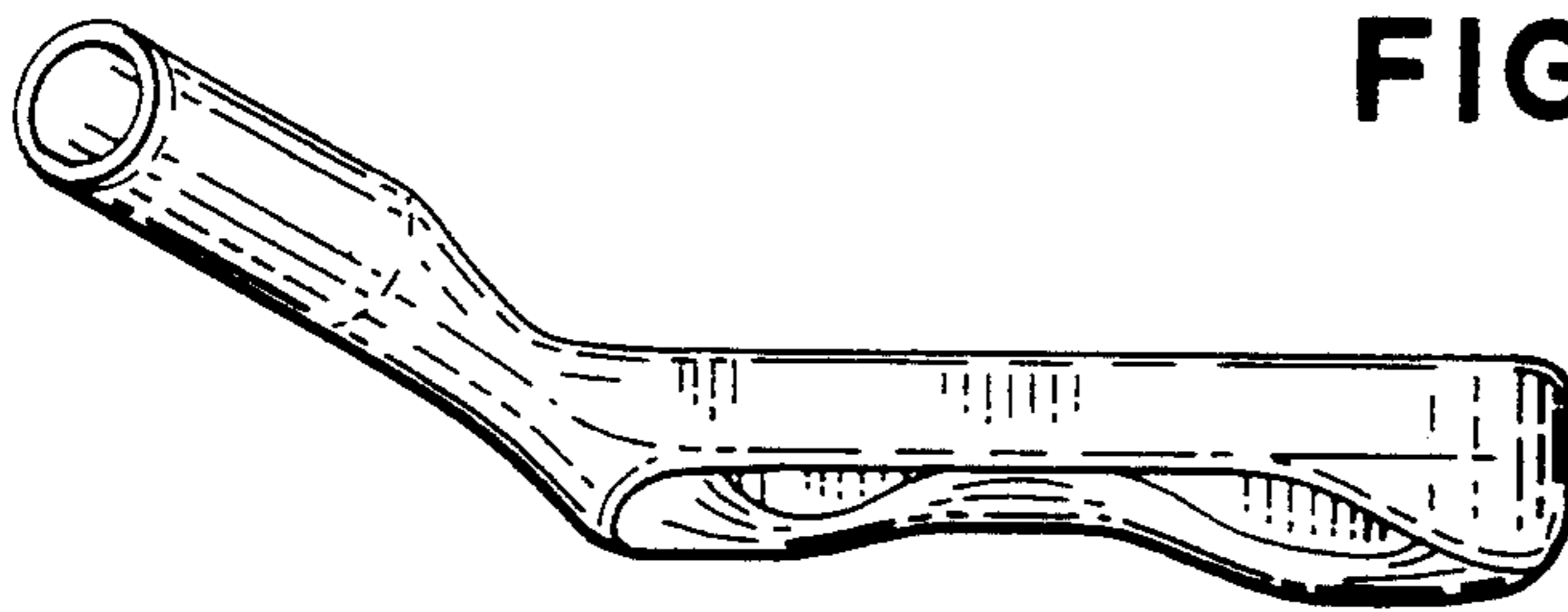

FIG. 4

FIG 5

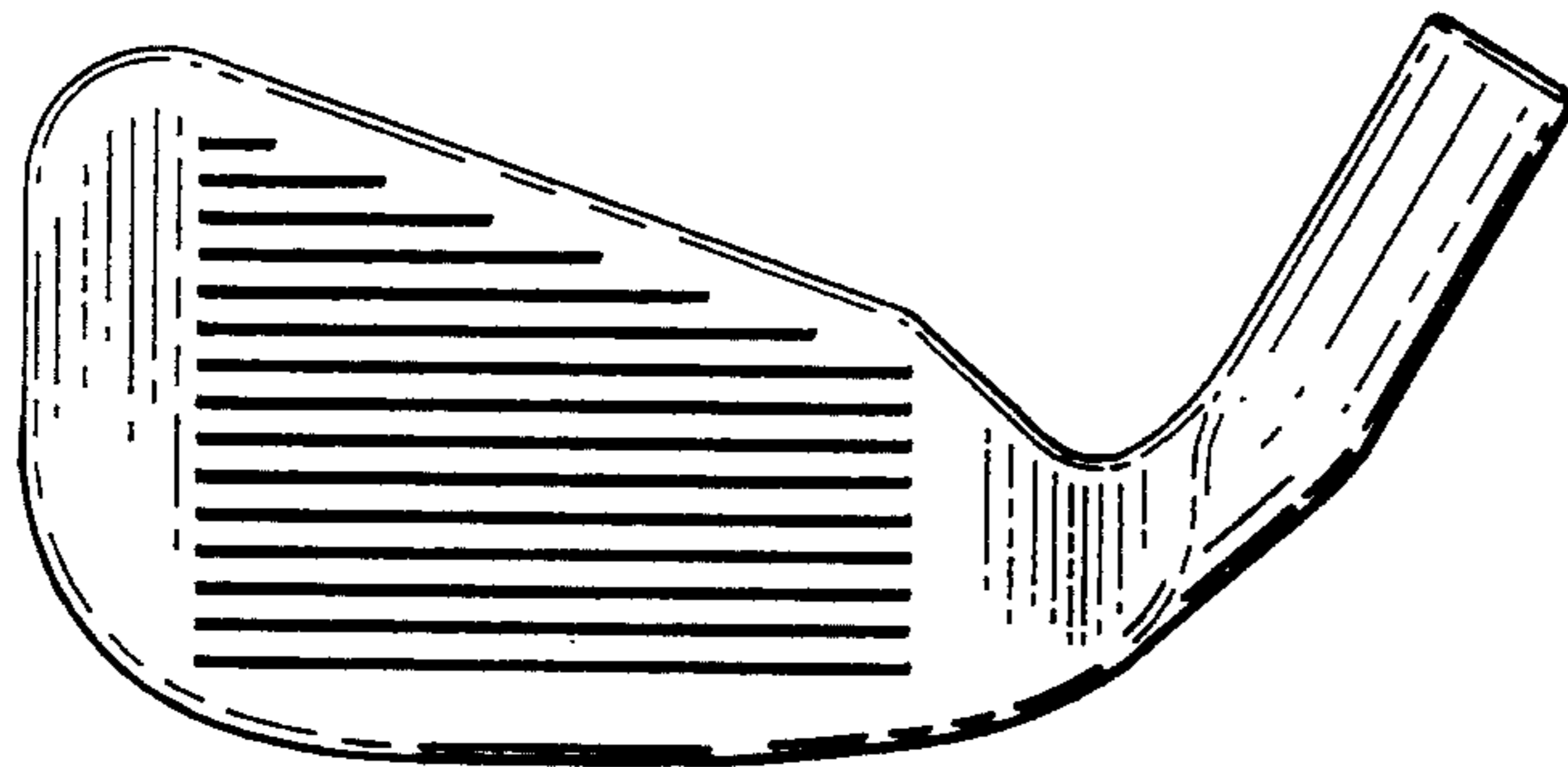
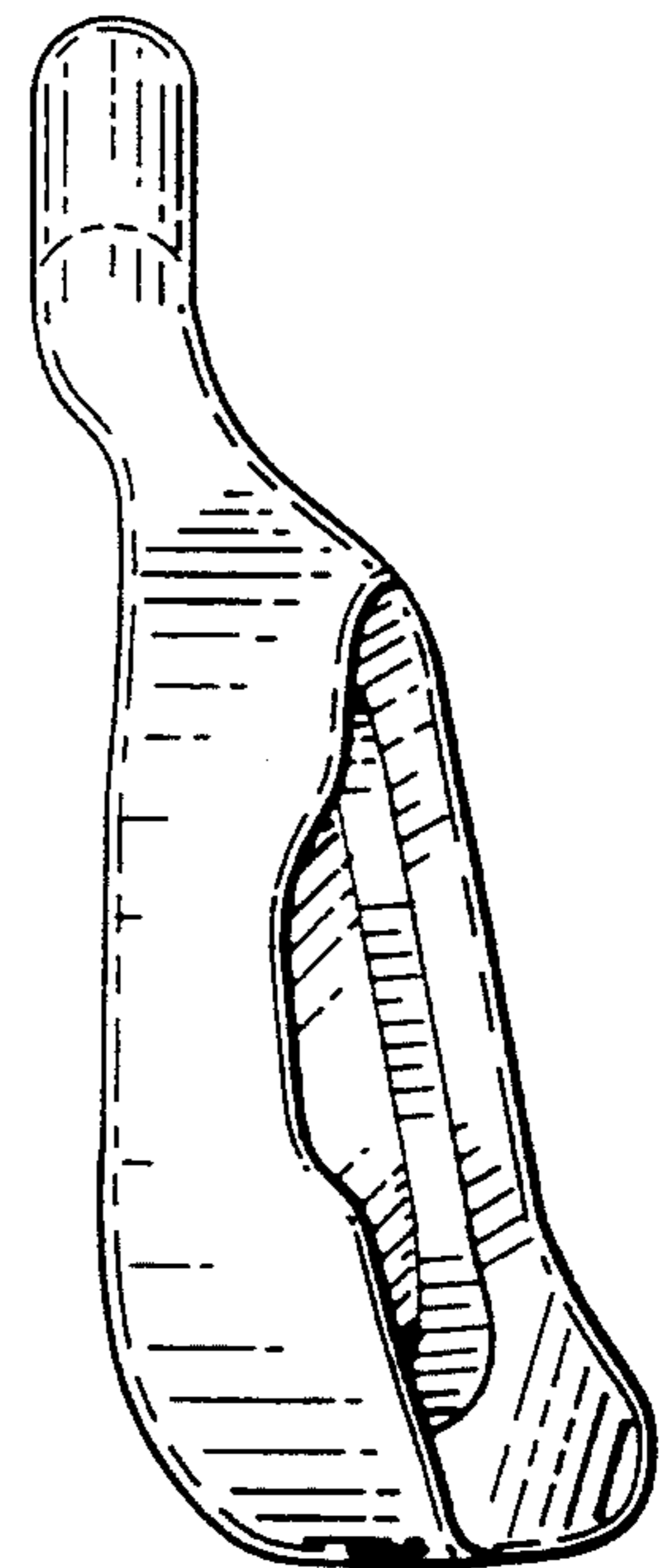

FIG. 6

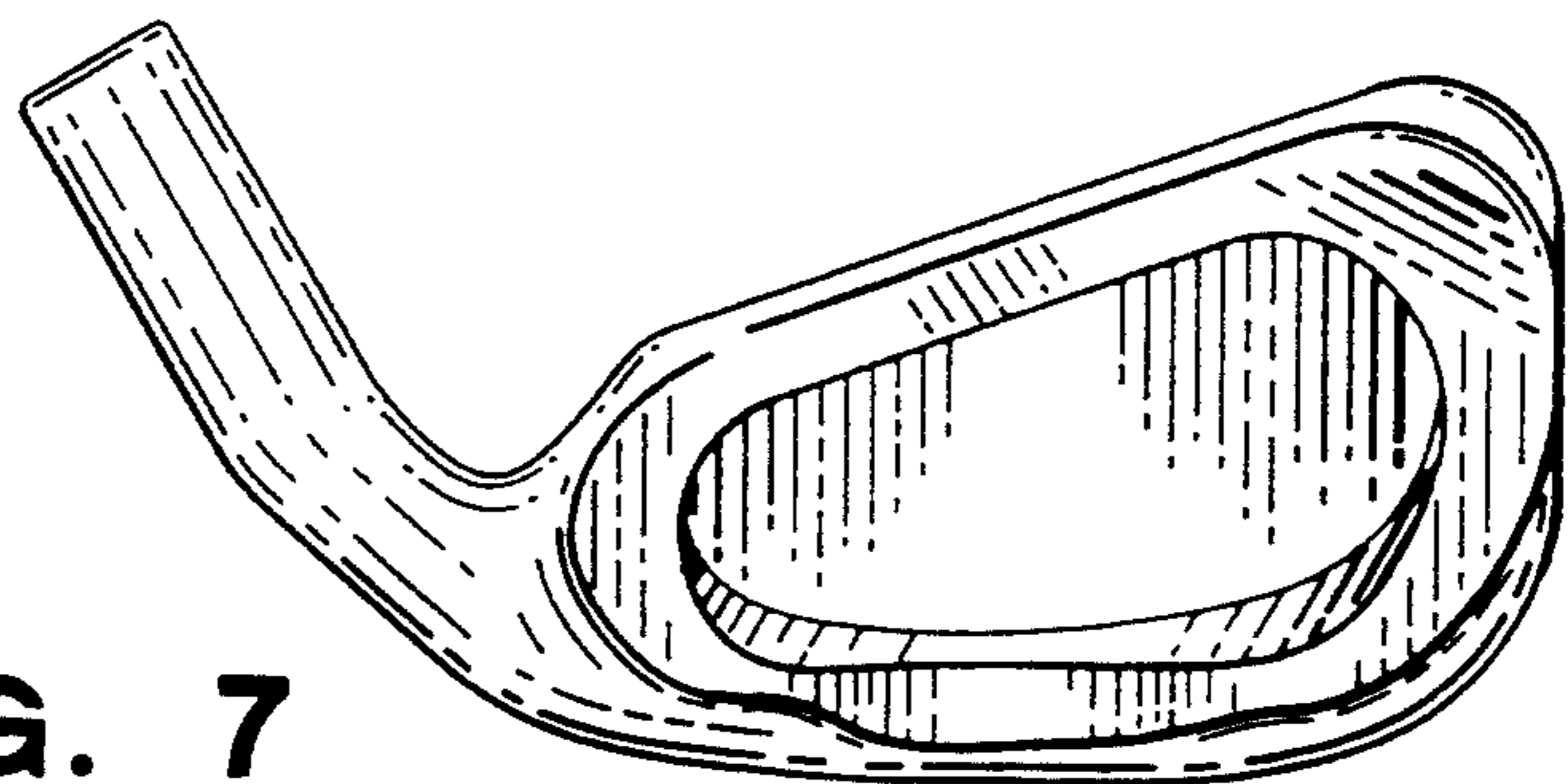
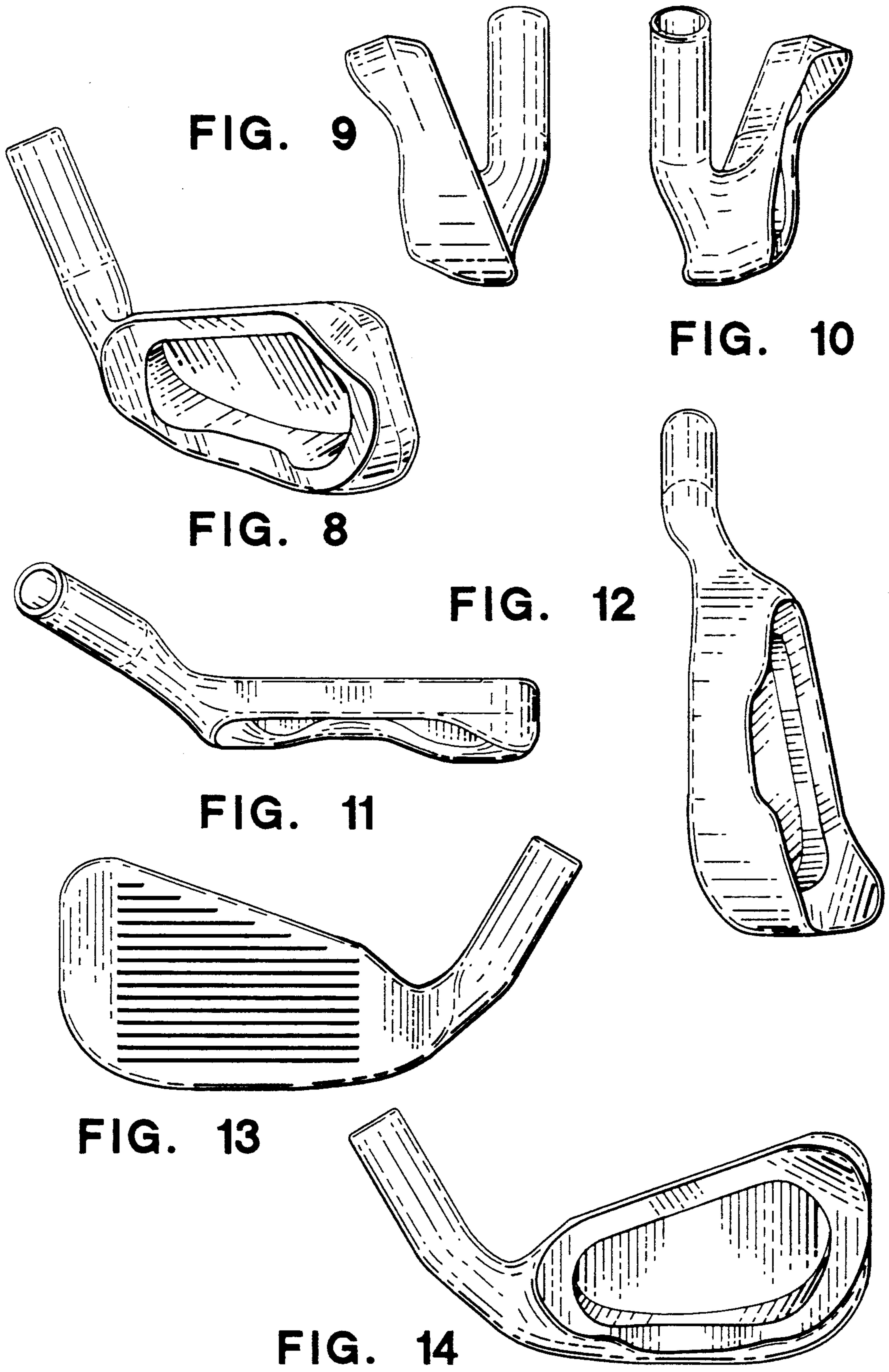

FIG. 7



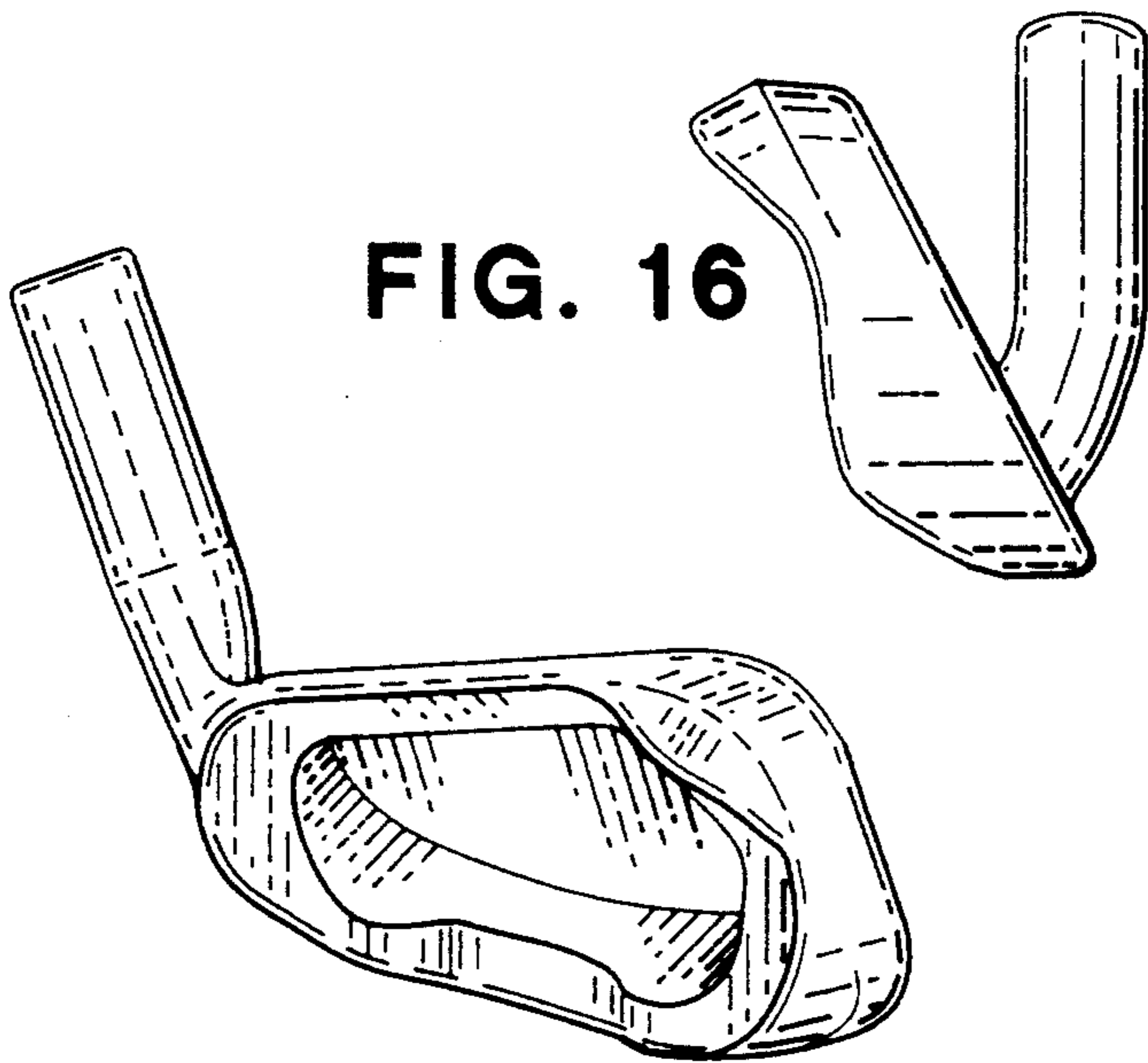

FIG. 16

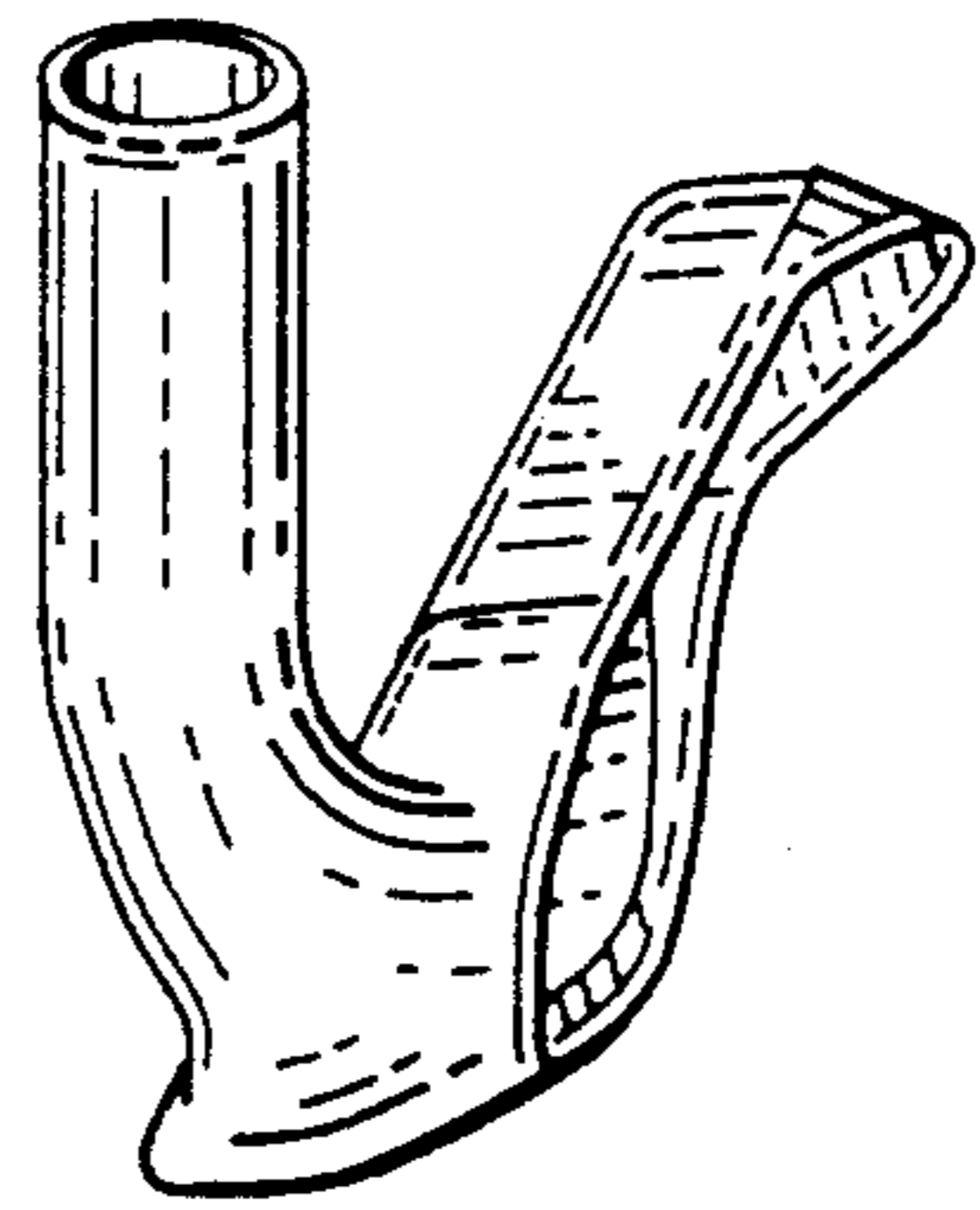

FIG. 17

FIG. 15

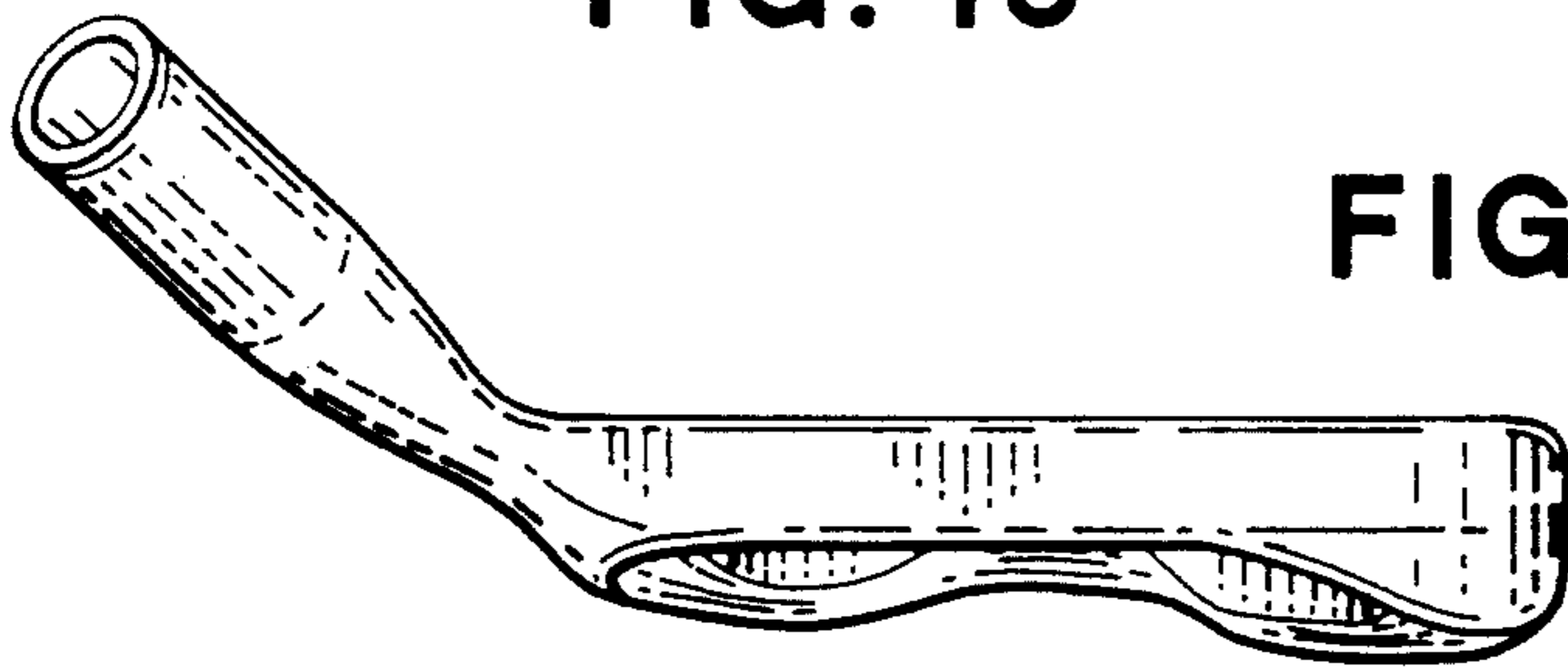

FIG. 19

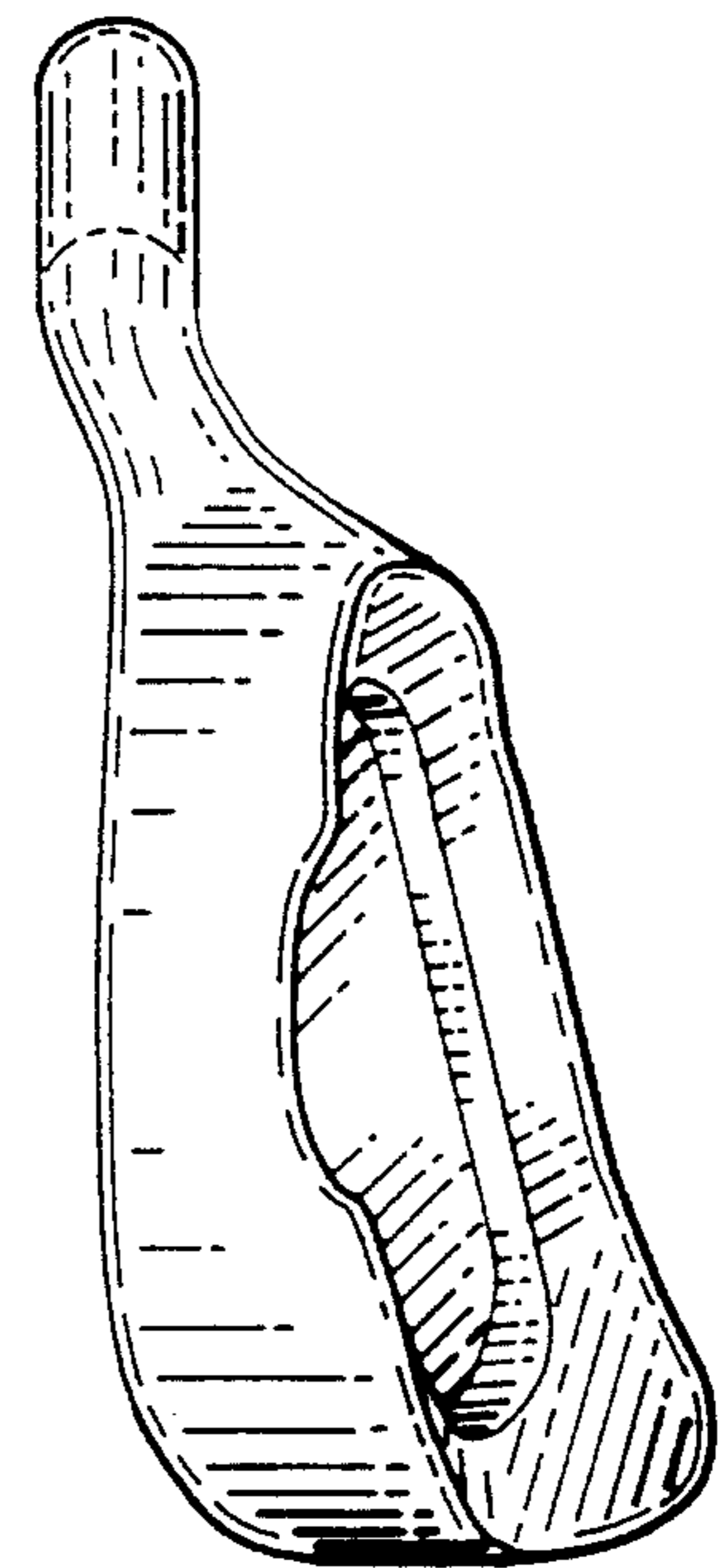

FIG. 18

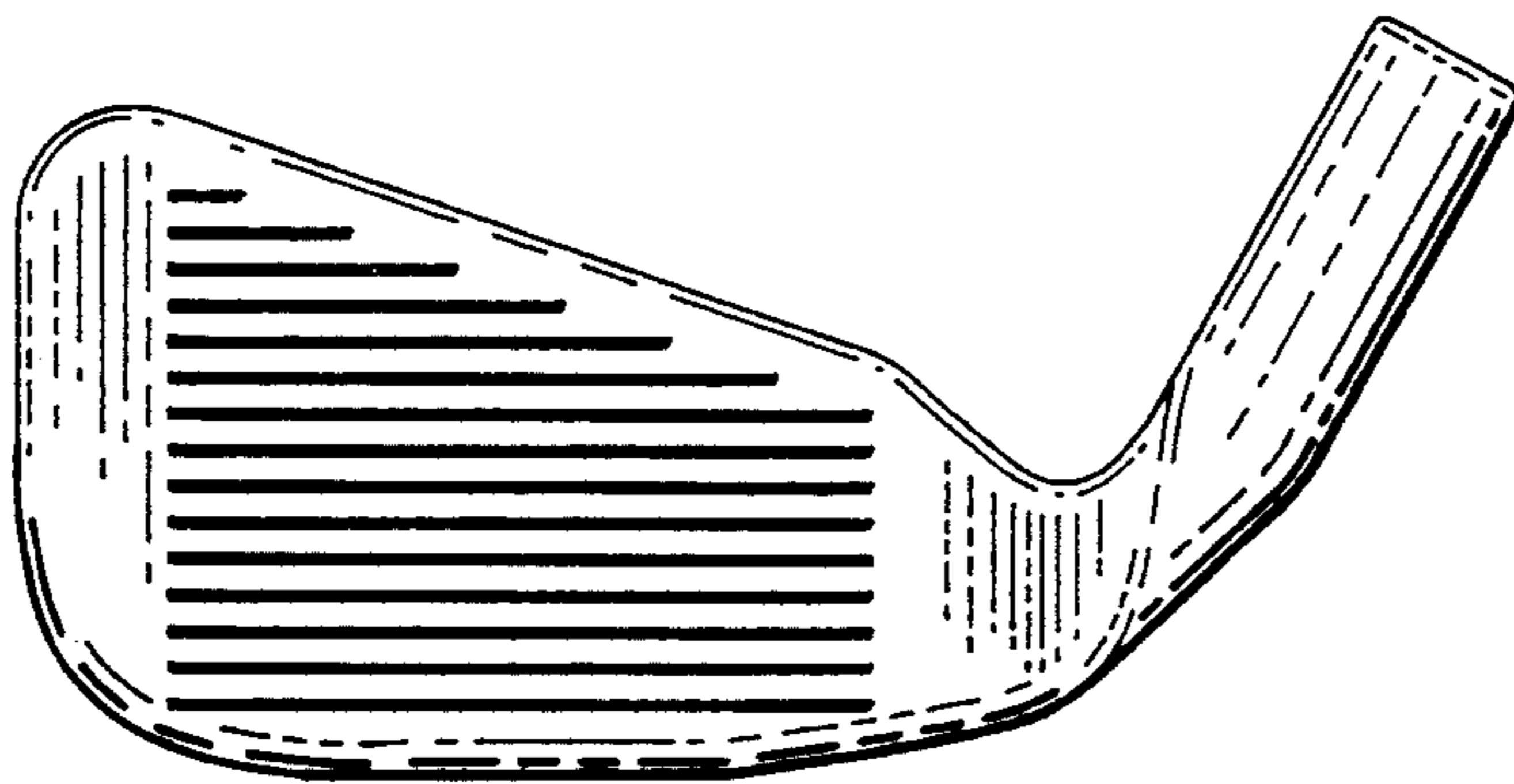

FIG. 20

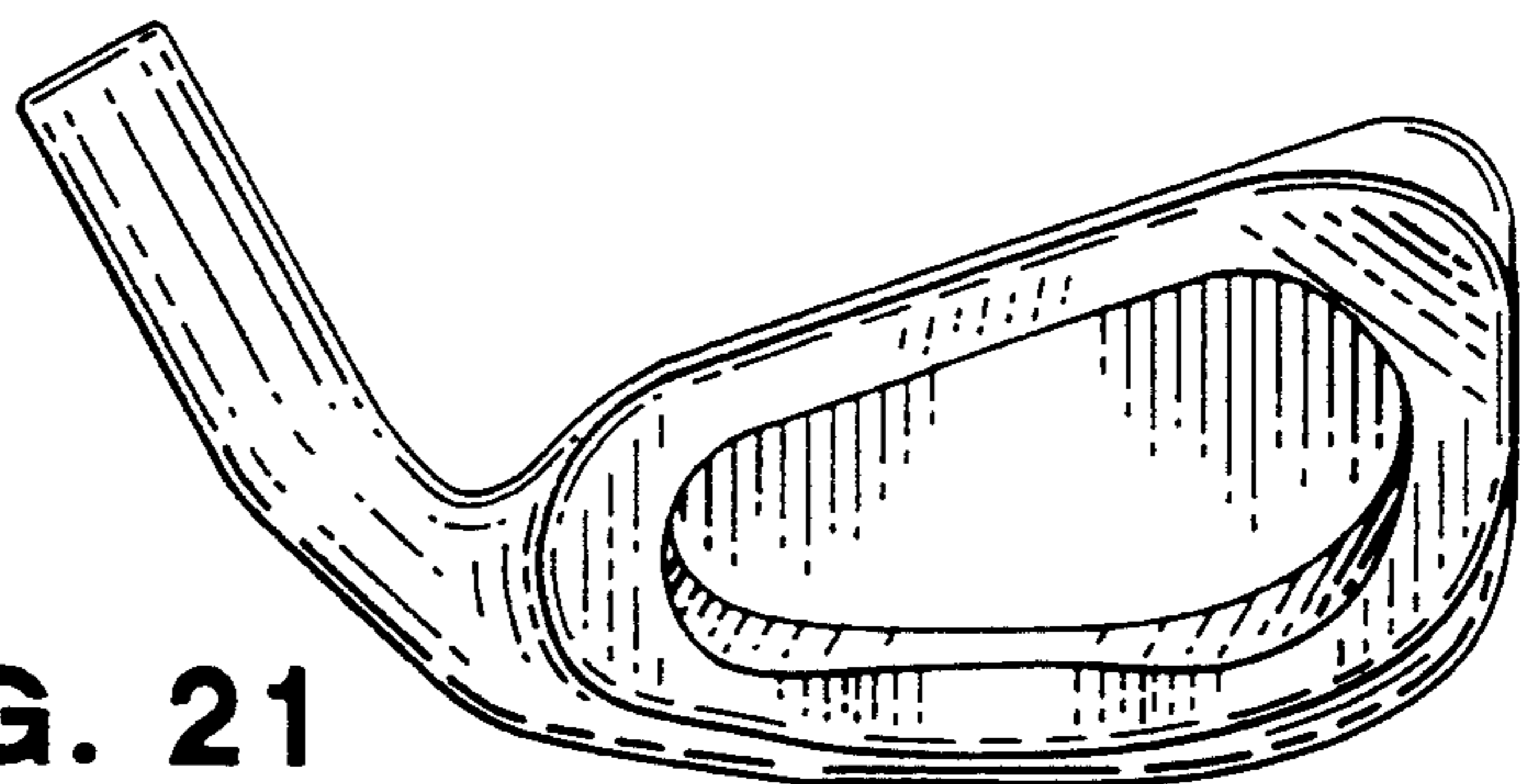

FIG. 21

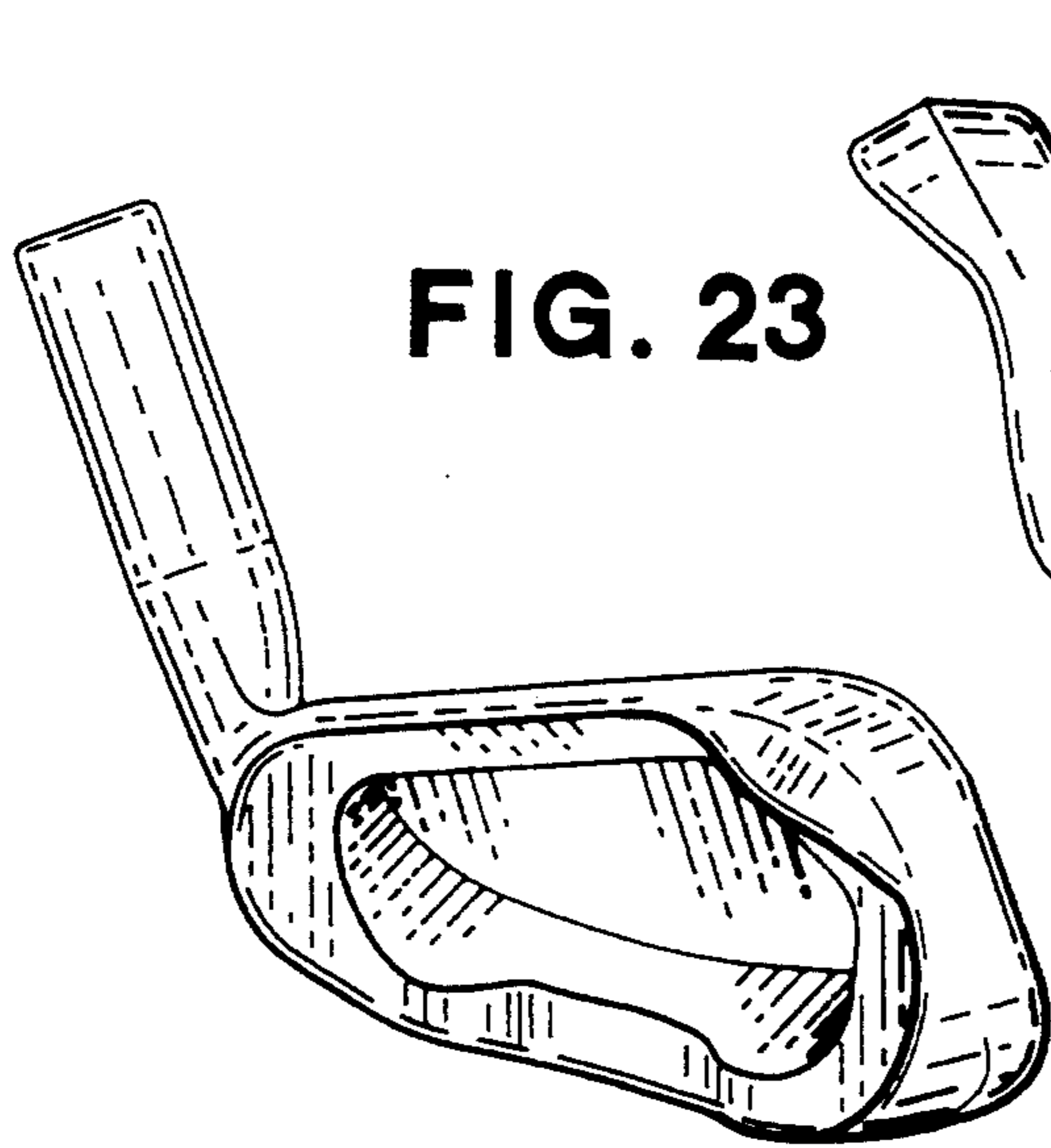

FIG. 23

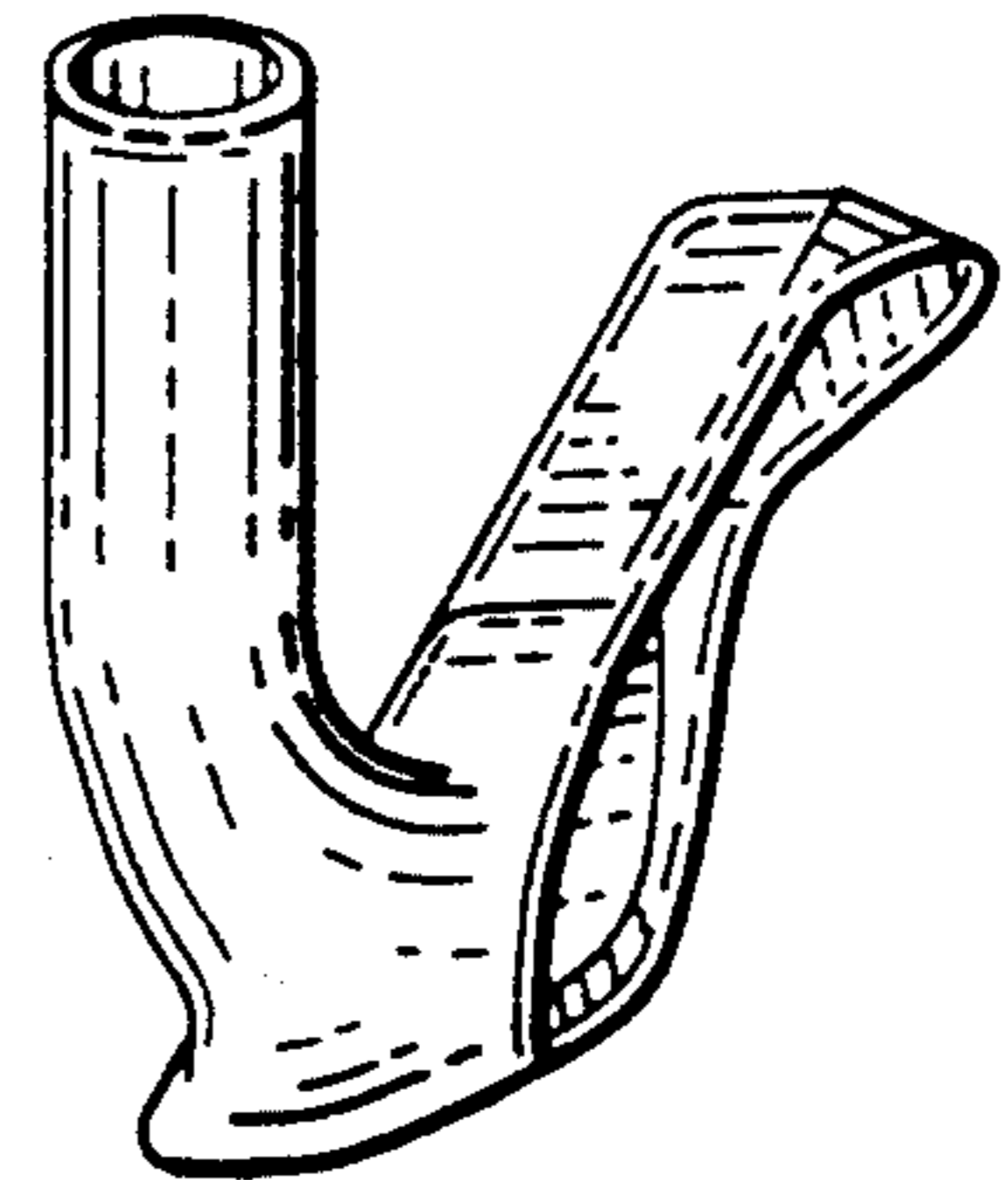
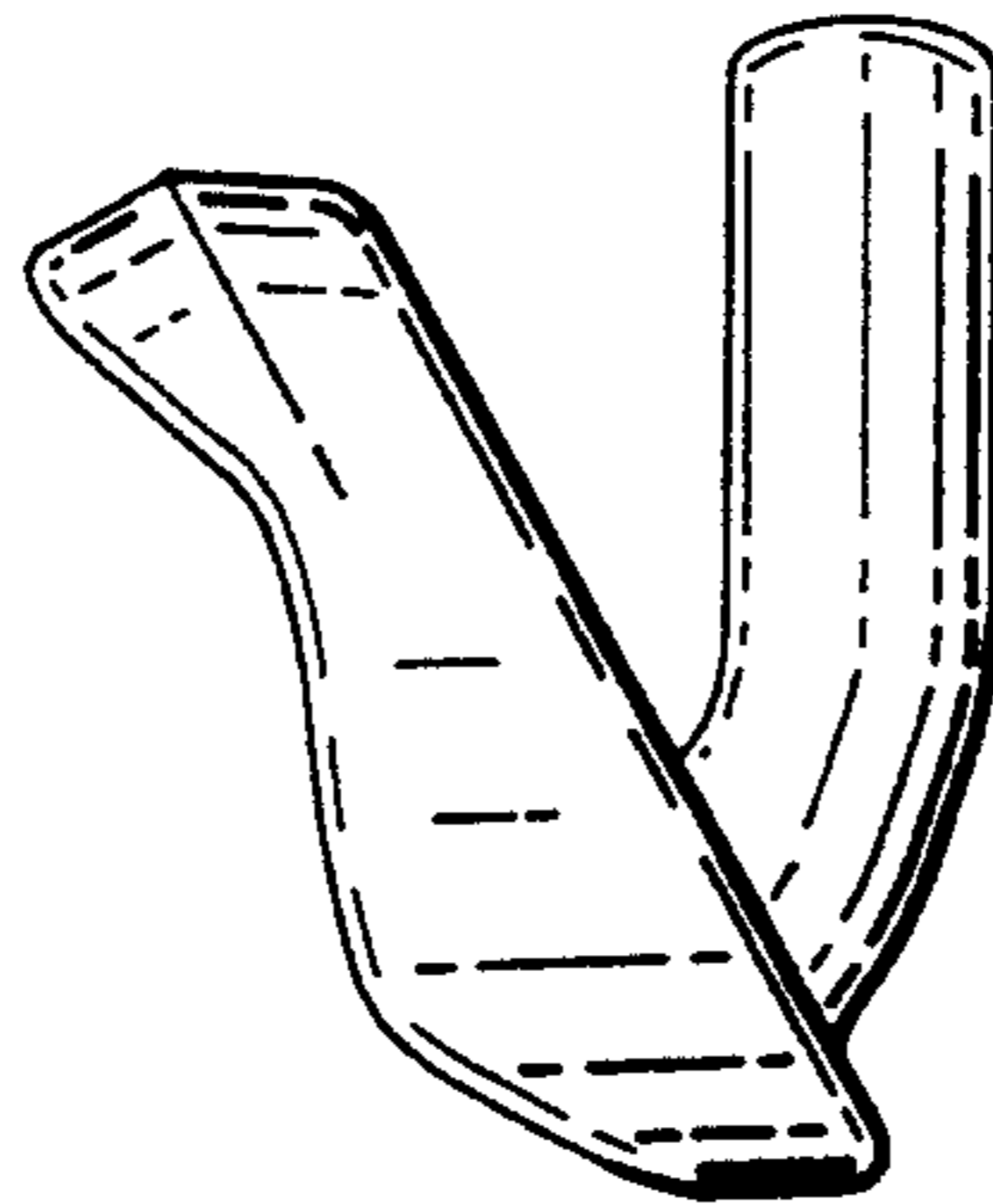

FIG. 24

FIG. 22

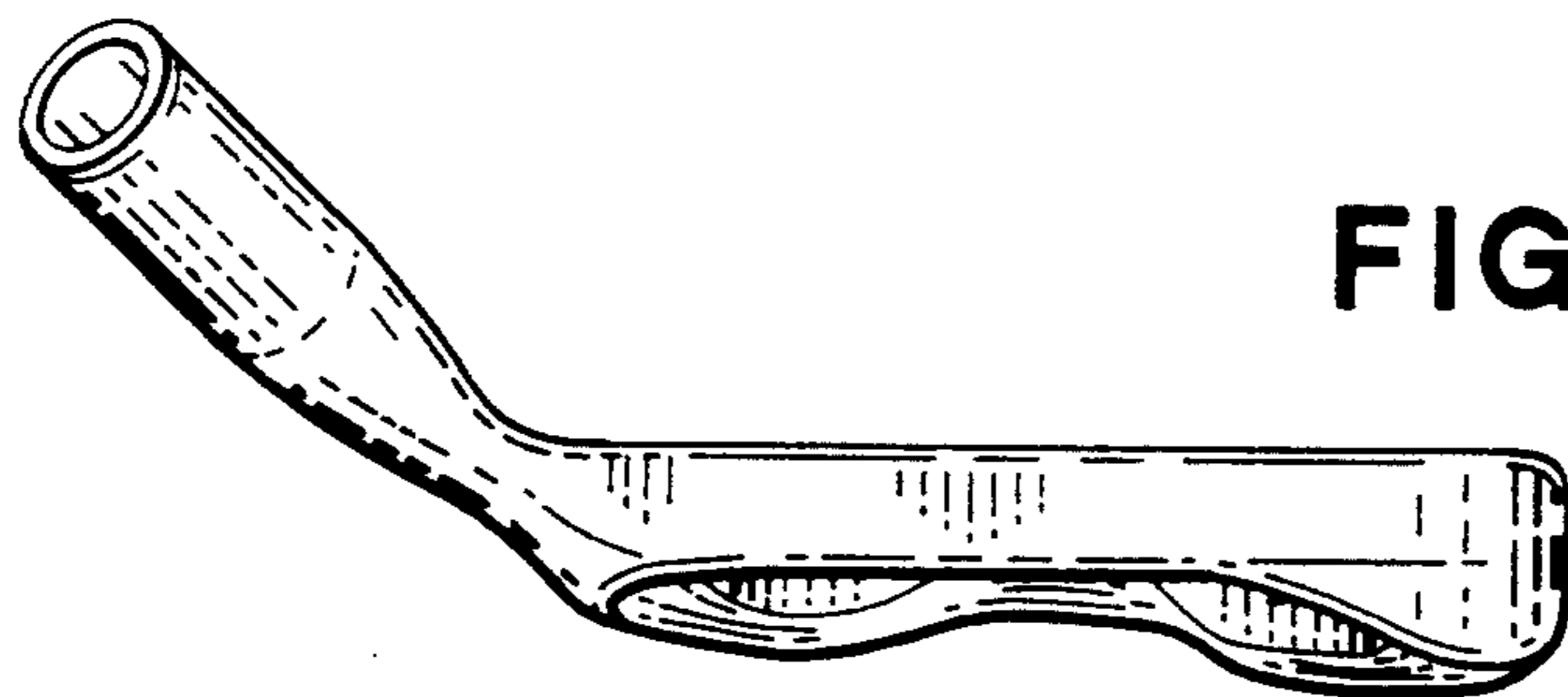

FIG. 26

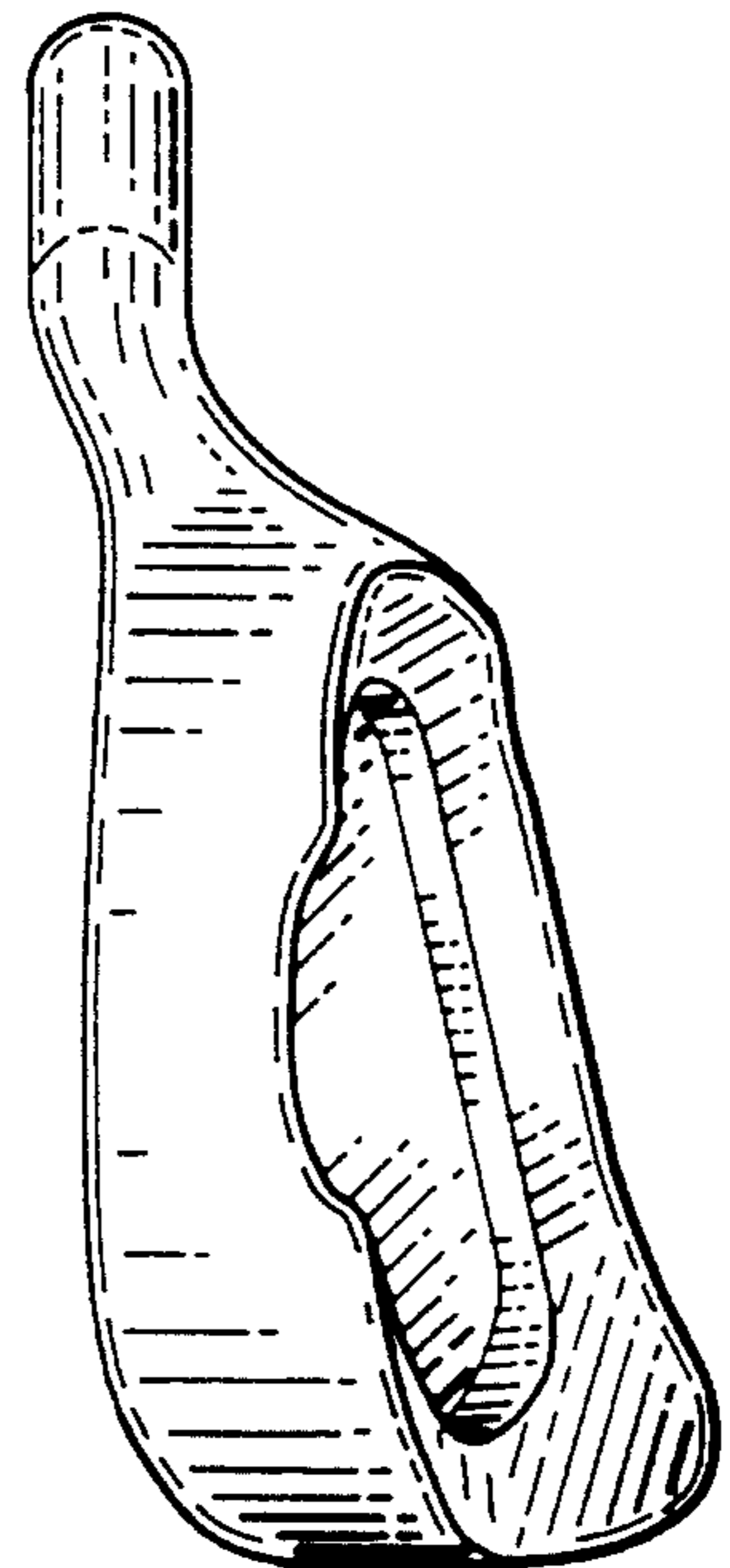

FIG. 25

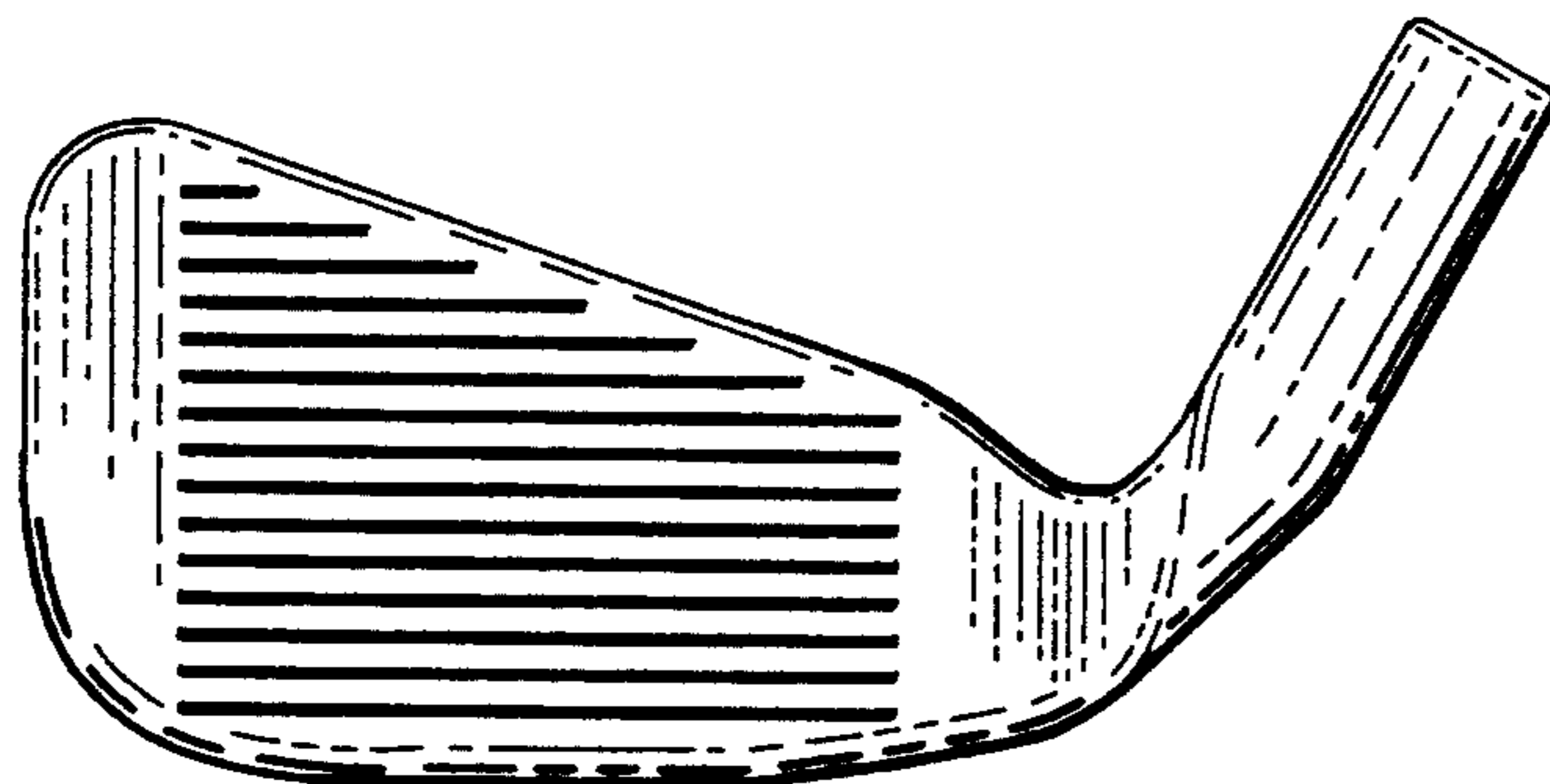

FIG. 27

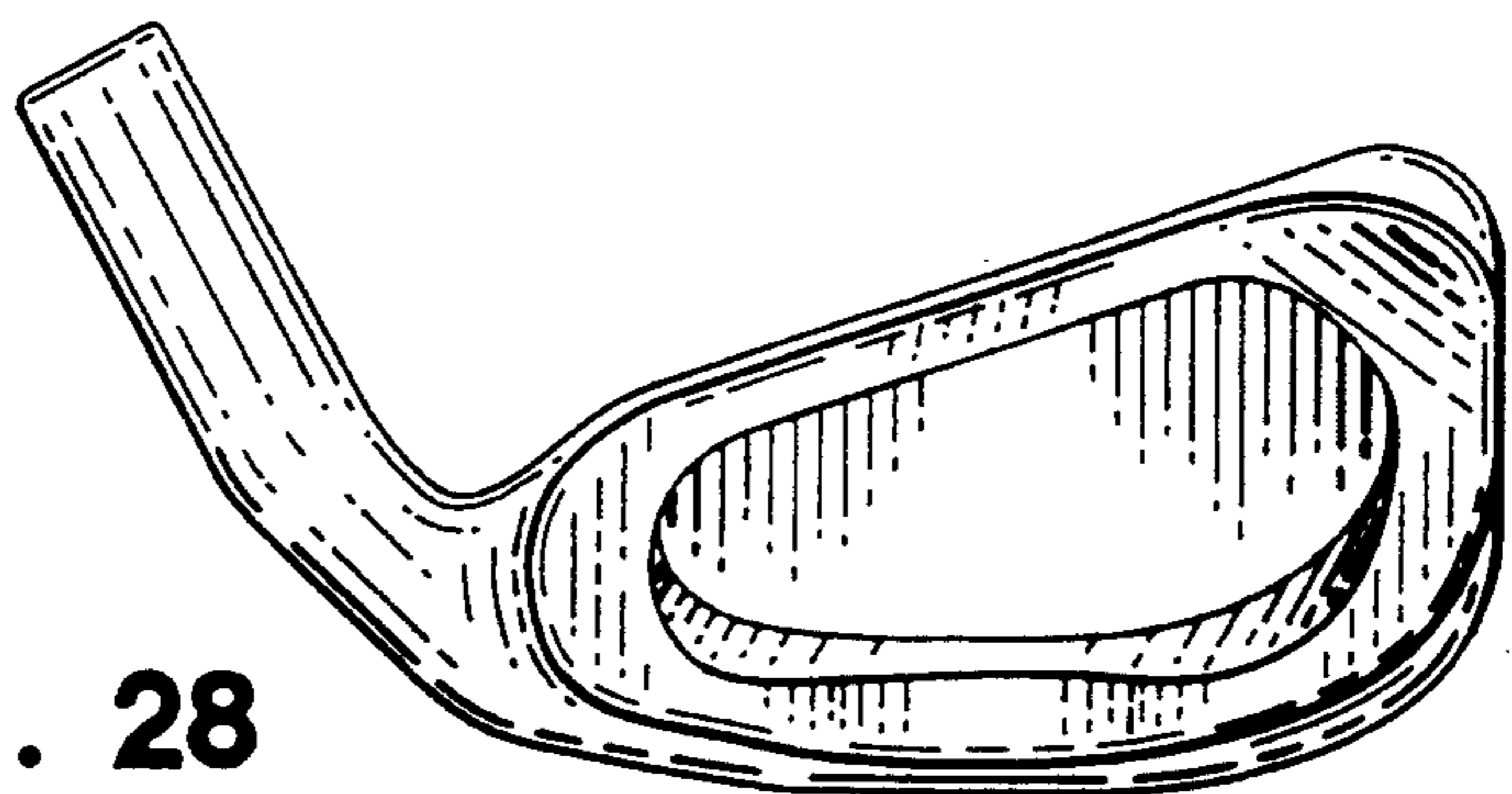

FIG. 28

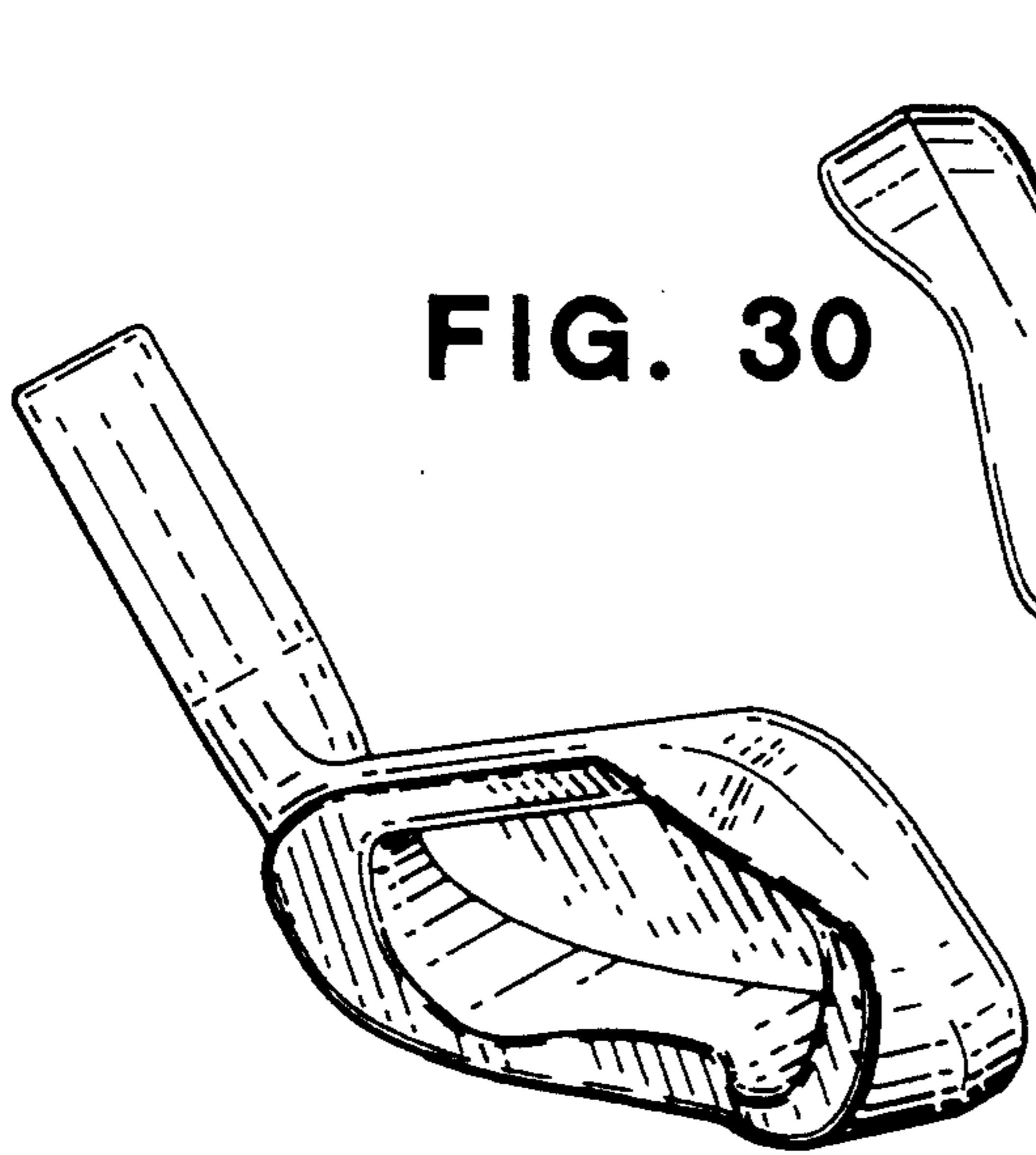

FIG. 30

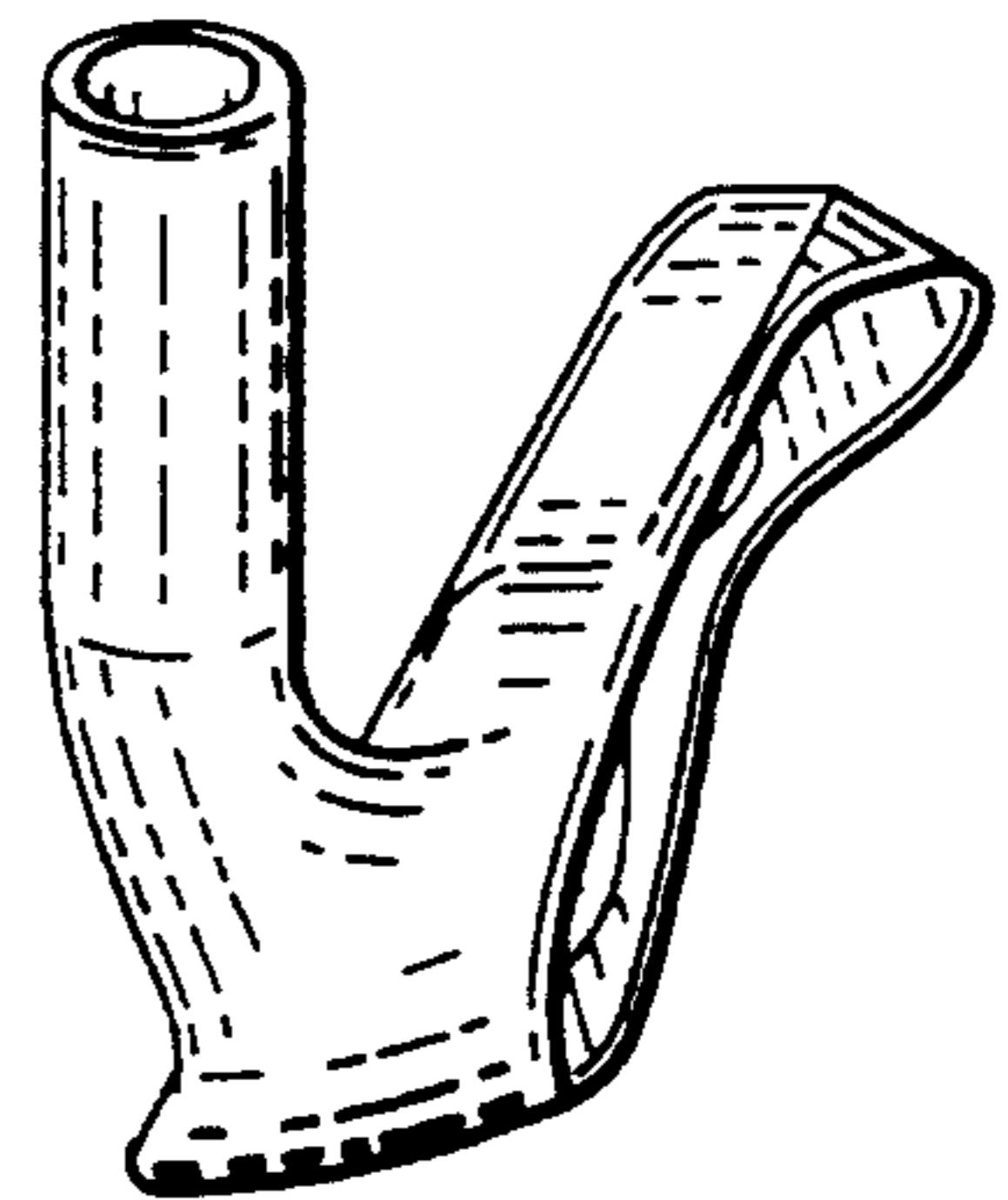

FIG. 31

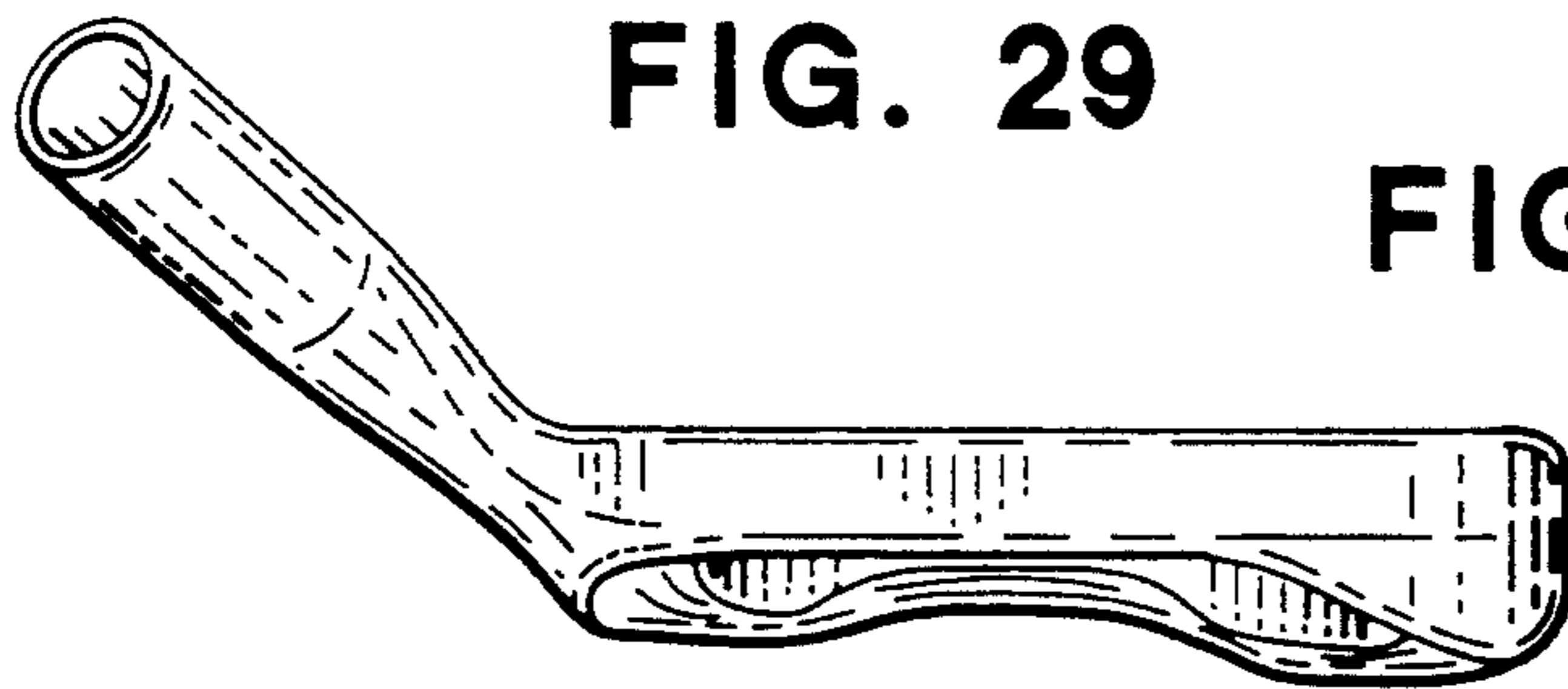

FIG. 29

FIG. 33

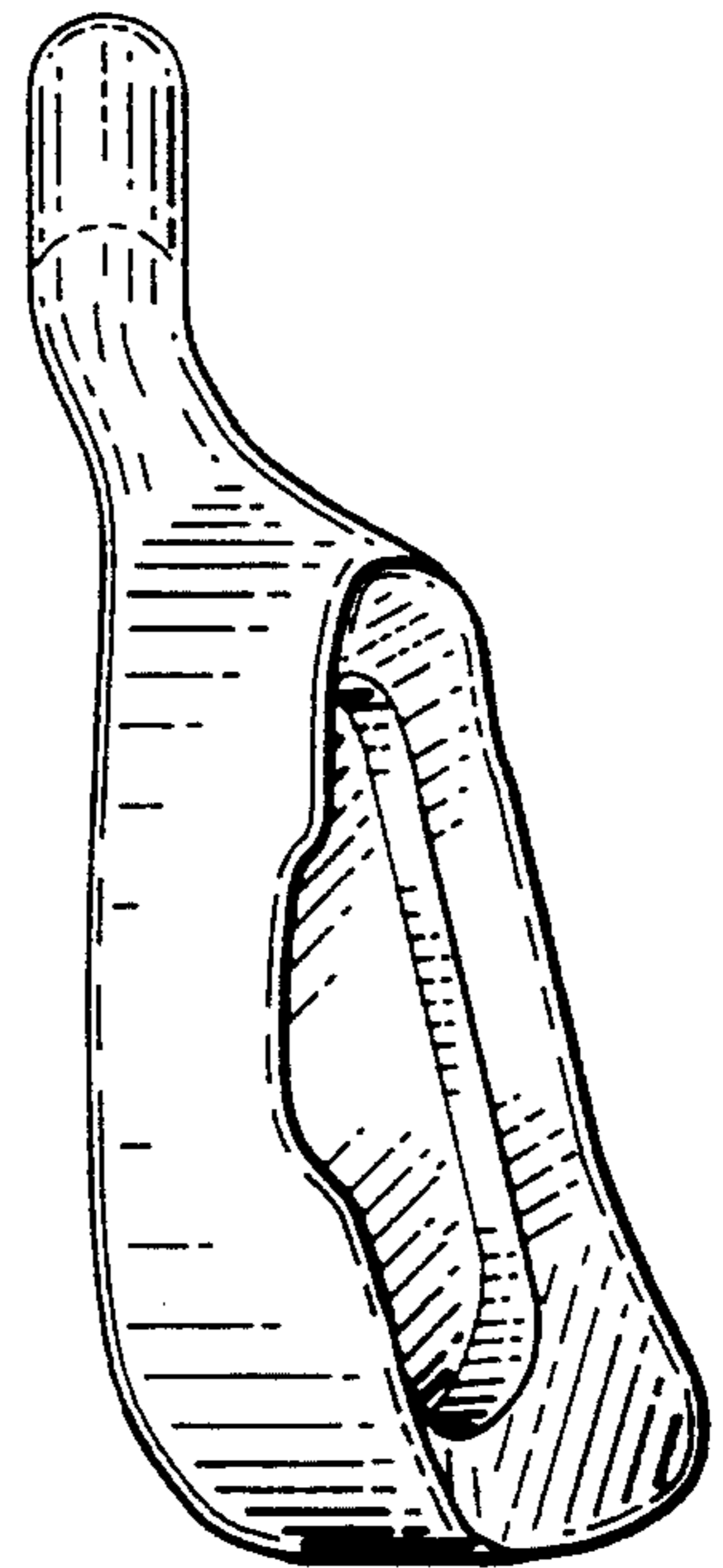

FIG. 32

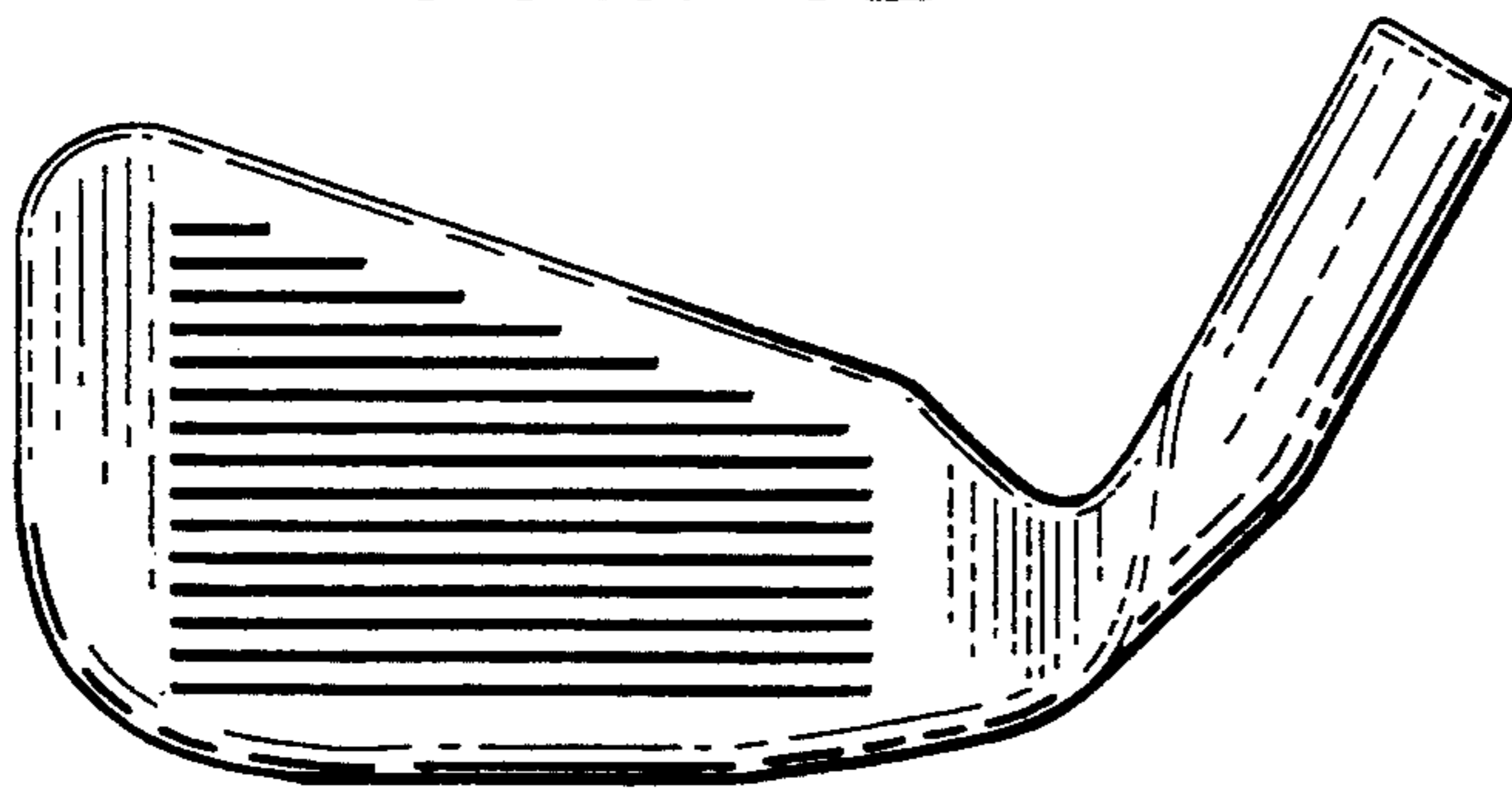

FIG. 34

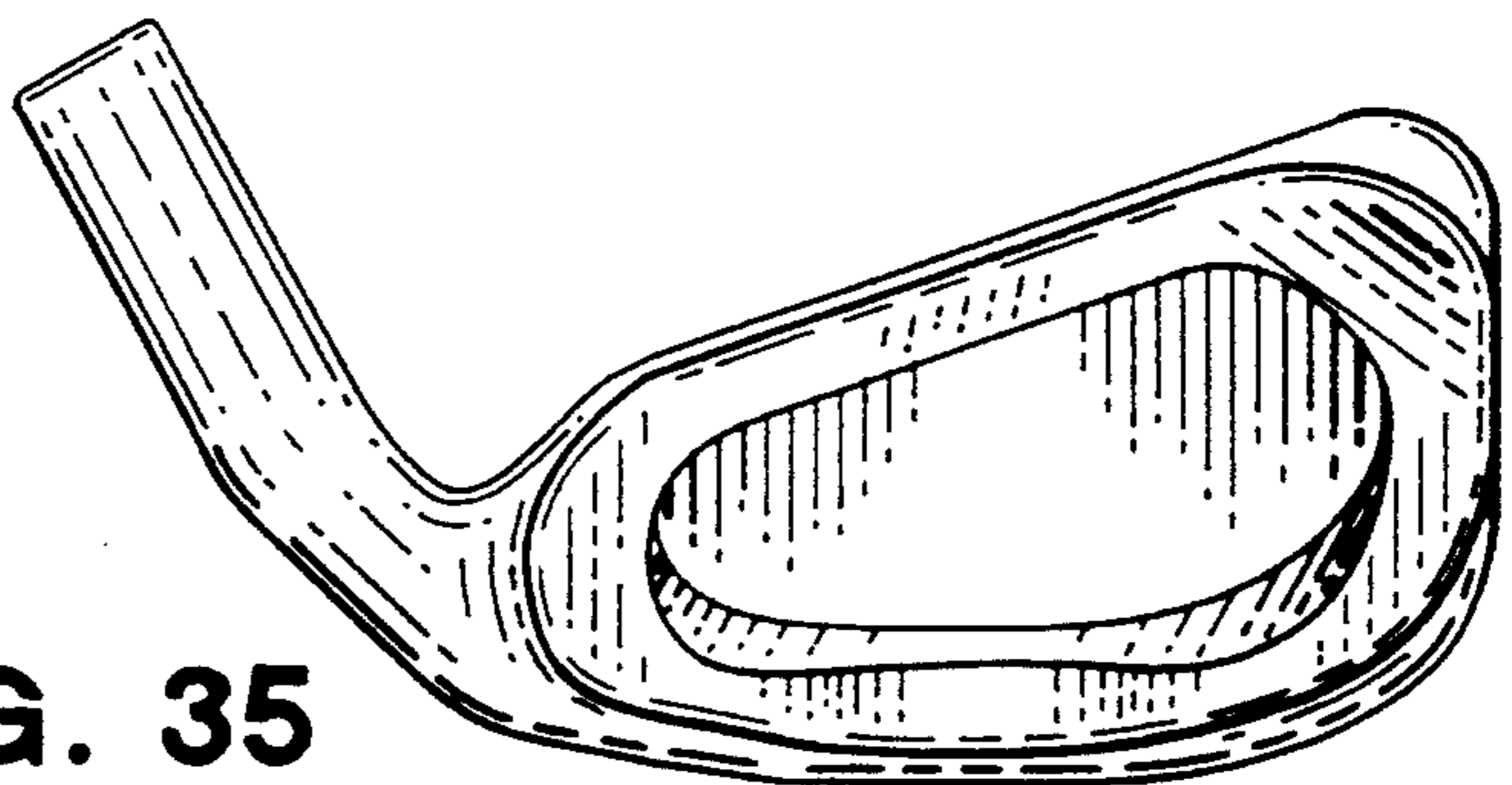

FIG. 35

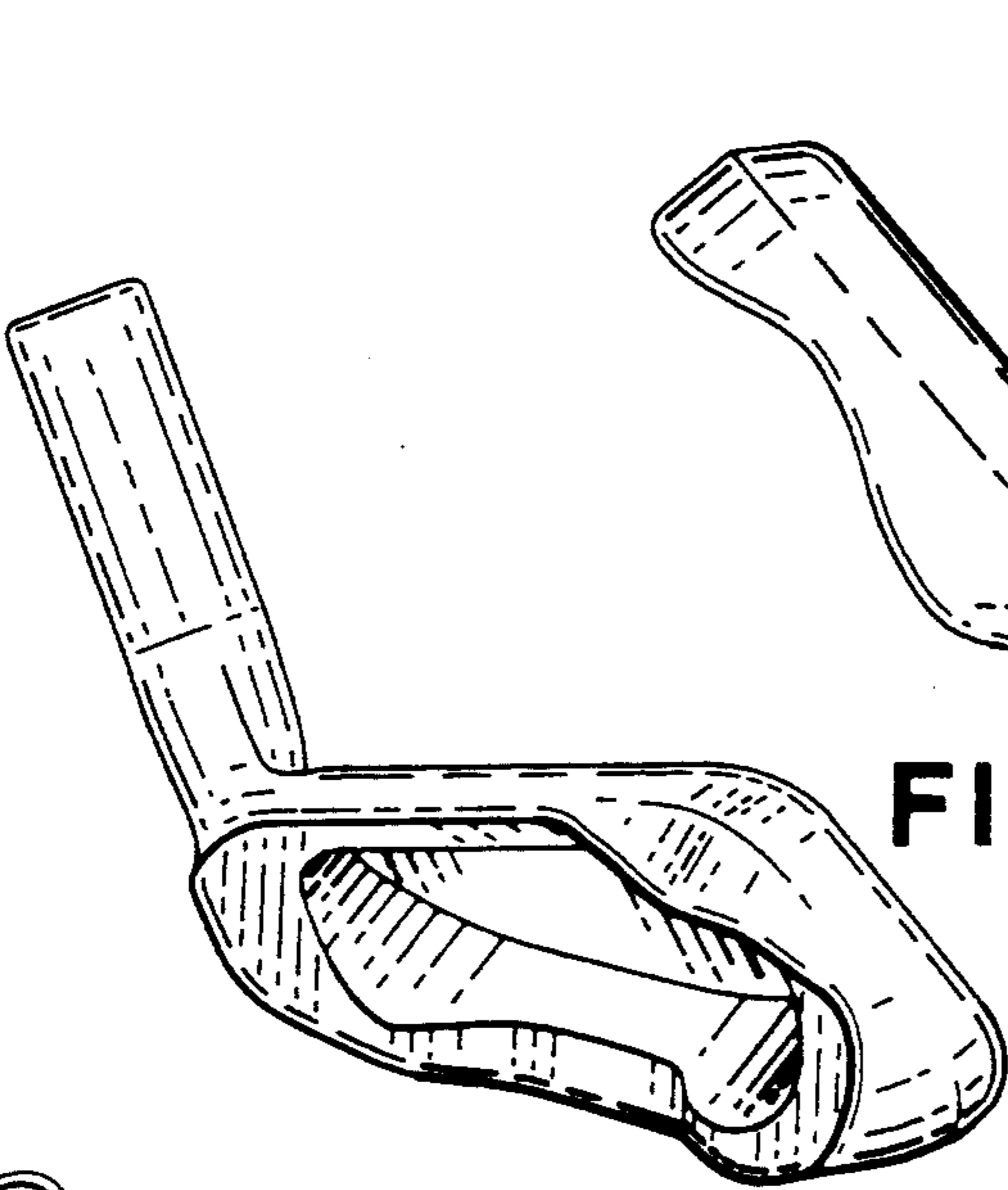

FIG. 36

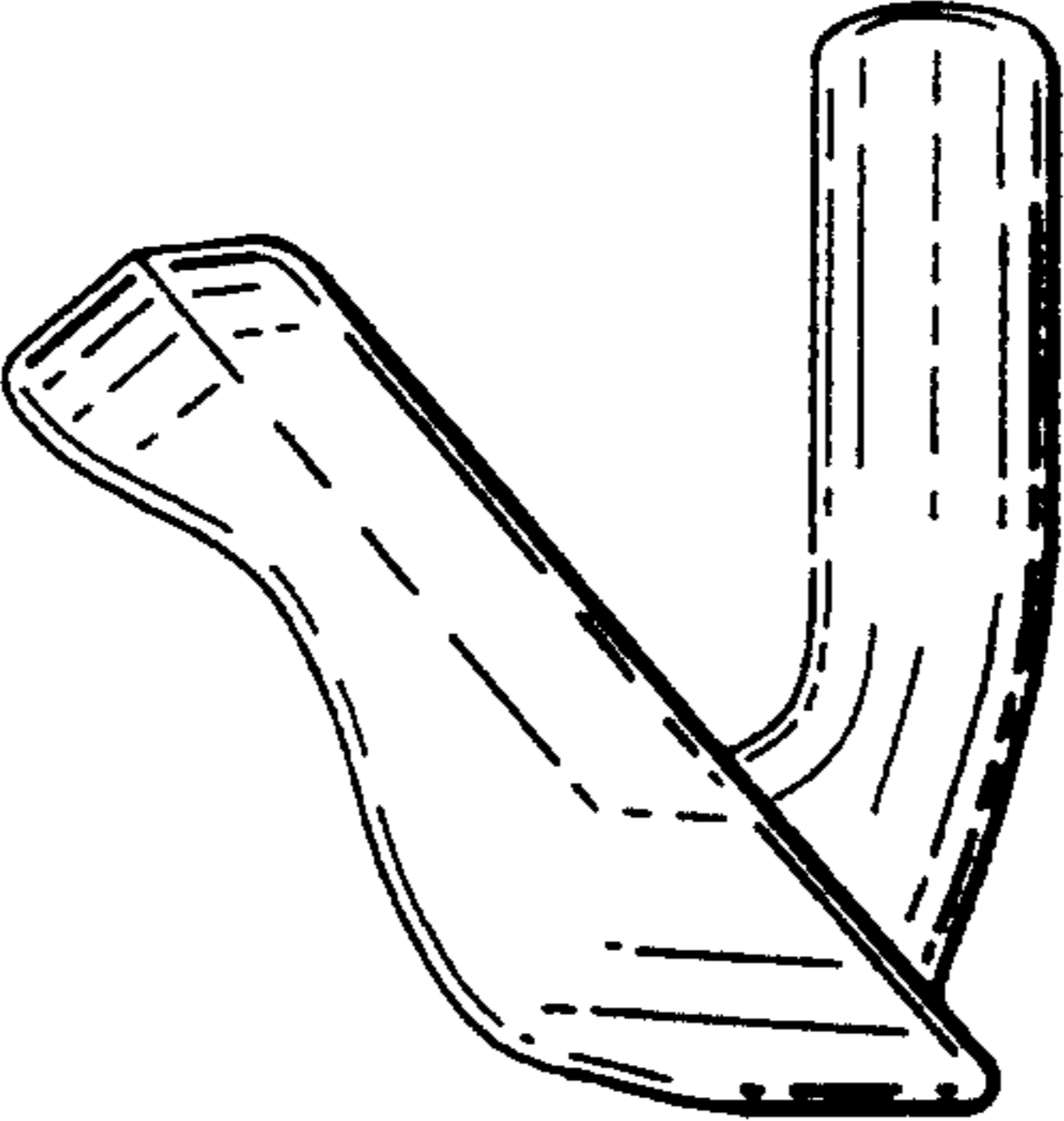

FIG. 37

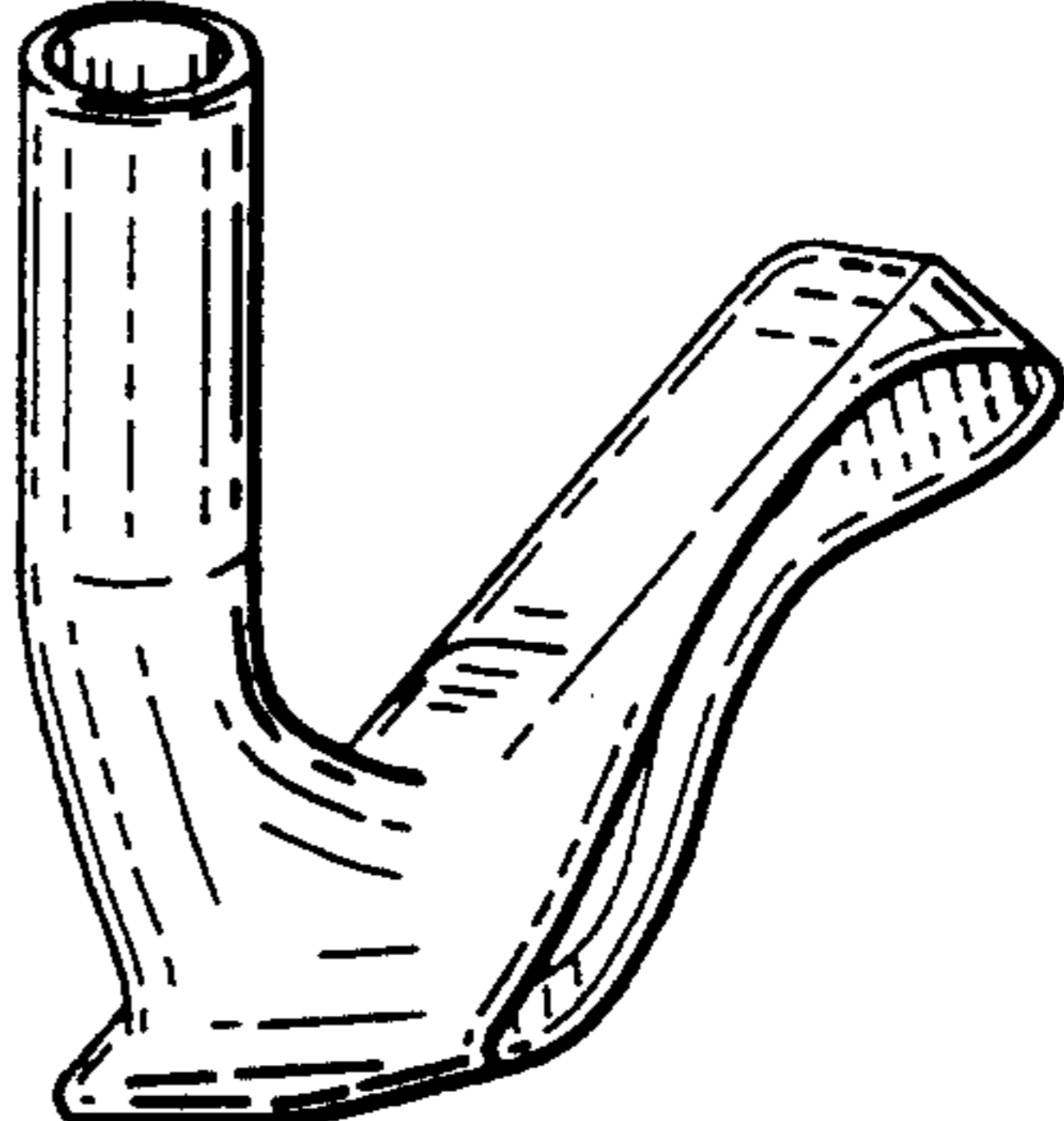

FIG. 38

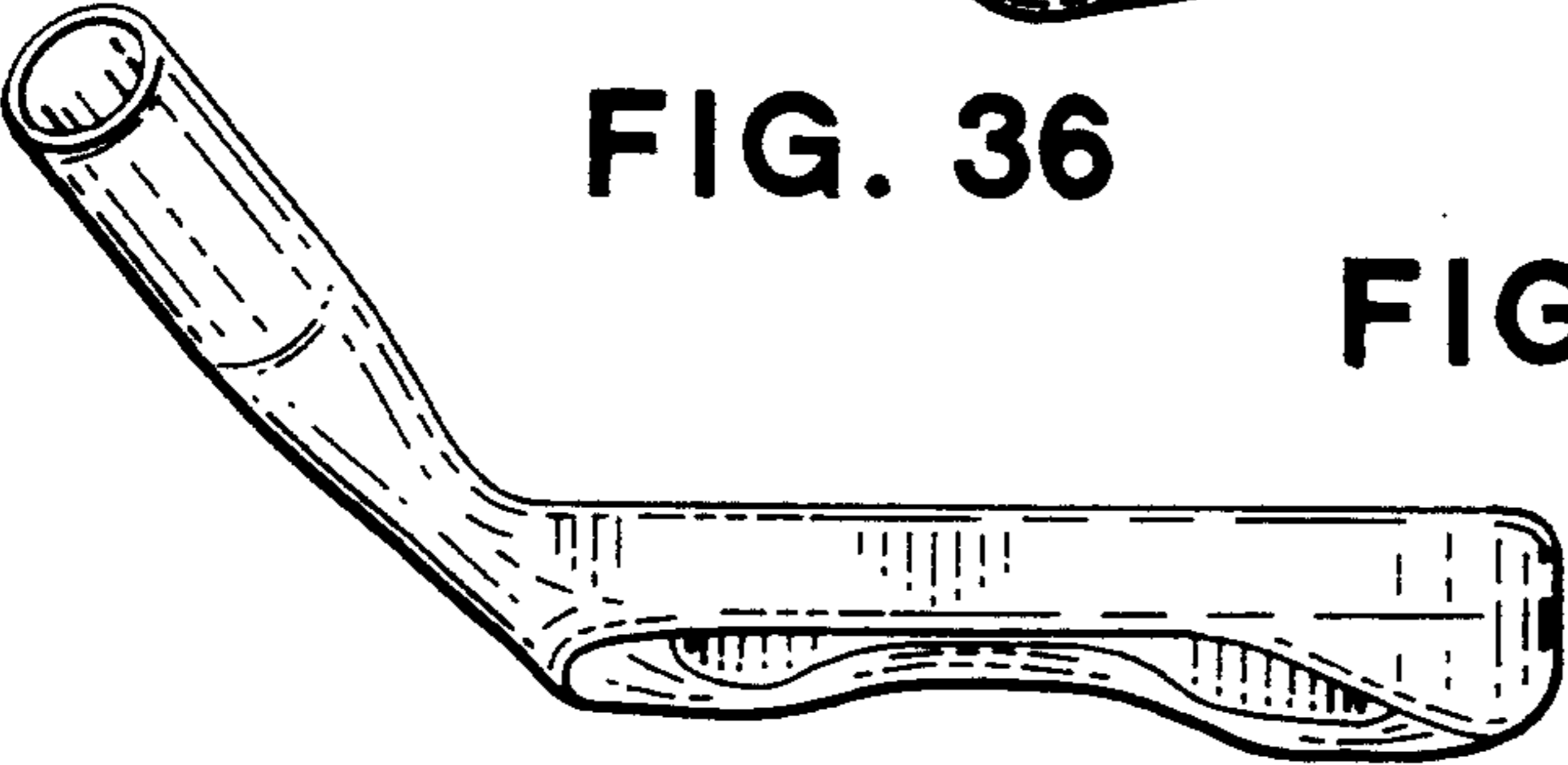

FIG. 39

FIG. 40

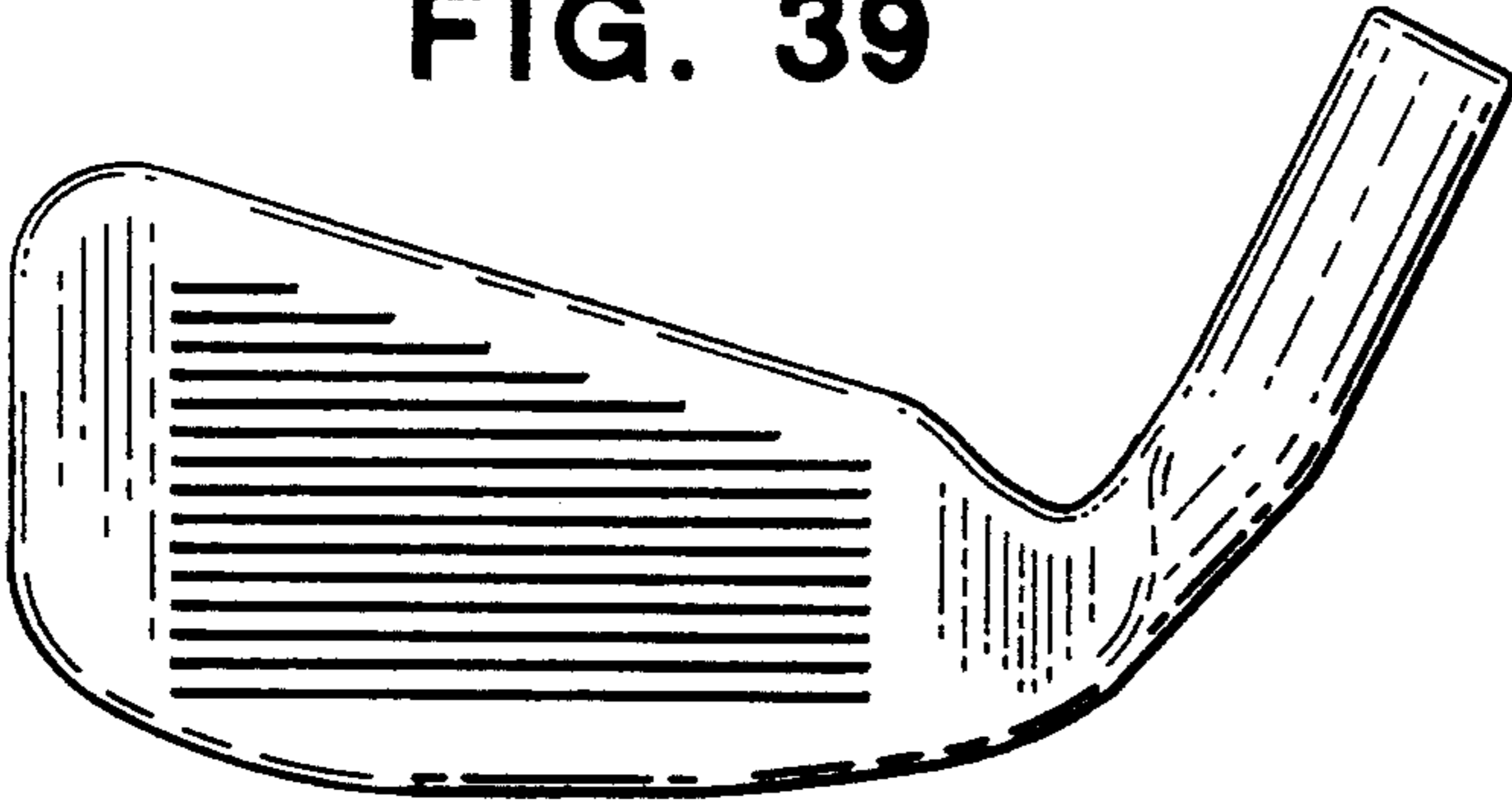
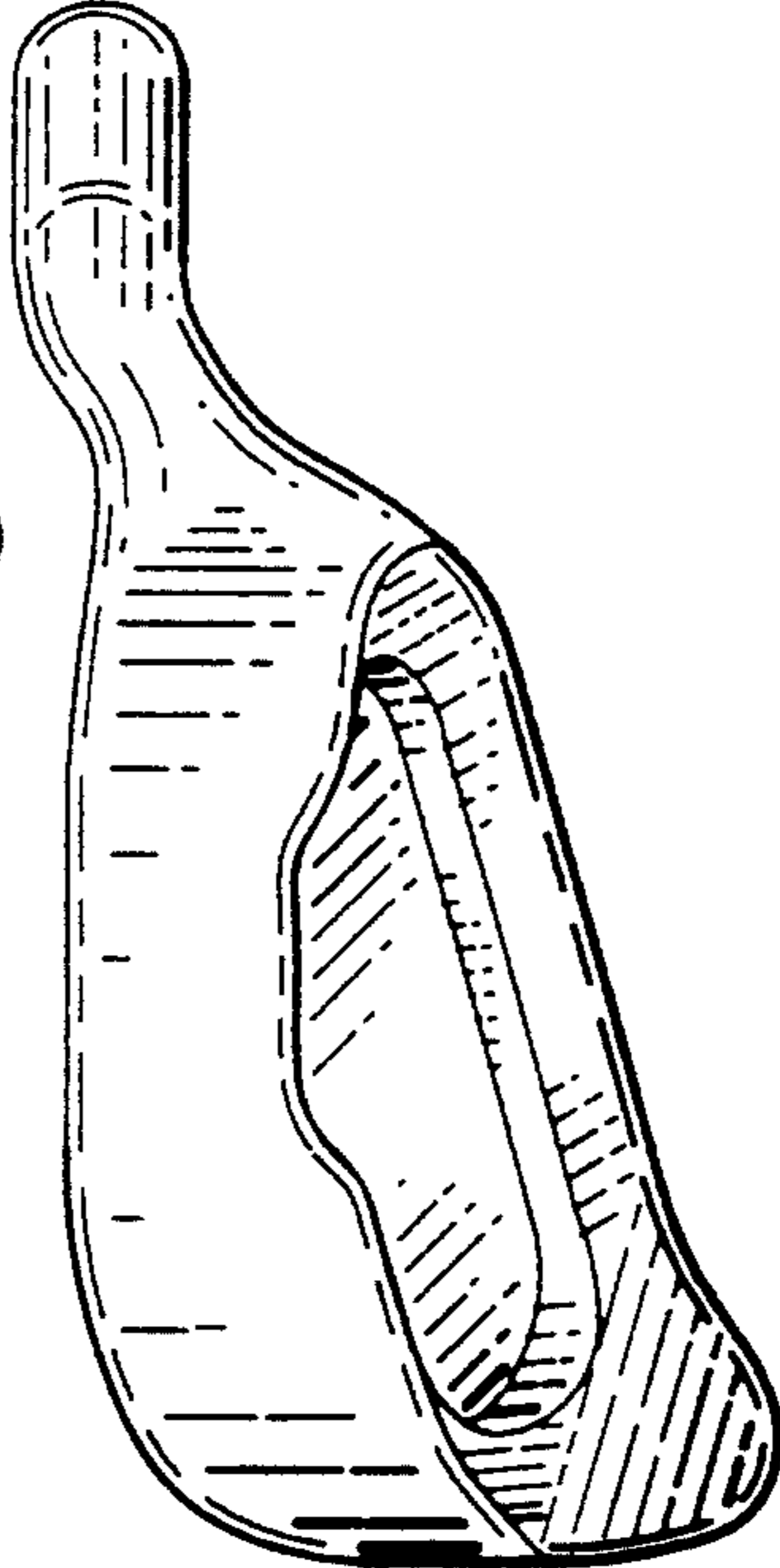

FIG 41

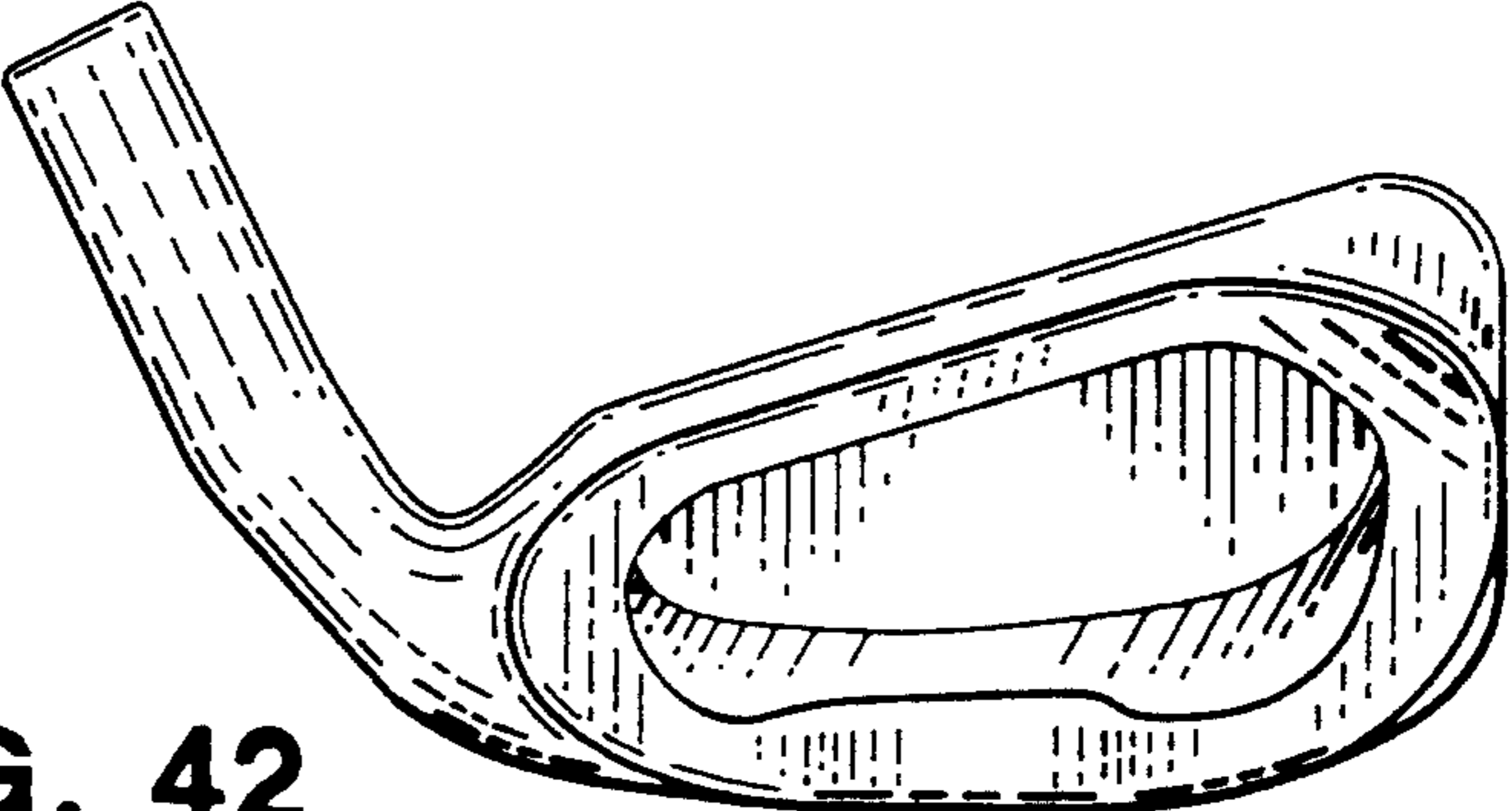

FIG. 42



