



US00D344724S

United States Patent [19]

[11] Patent Number: **Des. 344,724**

Pangburn

[45] Date of Patent: **** Mar. 1, 1994**

[54] **KEYBOARD**

[75] Inventor: **Thomas E. Pangburn, Lexington, Ky.**

[73] Assignee: **Lexmark International, Inc.,
Greenwich, Conn.**

[**] Term: **14 Years**

[21] Appl. No.: **805,269**

[22] Filed: **Dec. 10, 1991**

[52] U.S. Cl. **D14/115**

[58] Field of Search 340/700, 706, 710, 712;
341/22, 23; 364/708, 709.04; 361/390, 394;
400/472, 479, 485, 486, 488, 489; D14/100, 101,
106, 115; D18/1, 7, 11, 12

D. 304,451	11/1989	Kagayama et al.	D14/115
D. 308,199	5/1990	Sotsass	D14/115
D. 308,200	5/1990	Sotsass	D14/115
D. 308,360	6/1990	Schaum	D14/100
D. 311,171	10/1990	Santer	D14/100
D. 311,384	10/1990	Lazere et al.	D14/100
D. 311,524	10/1990	Lazere et al.	D14/100
D. 330,199	10/1992	Mendel et al.	D14/115
D. 335,660	5/1993	Busch	D14/115

Primary Examiner—Susan J. Lucas

Assistant Examiner—Freda S. Nunn

Attorney, Agent, or Firm—B. Franklin Griffin, Jr.

[57] **CLAIM**

The ornamental design for a keyboard, as shown and described.

DESCRIPTION

FIG. 1 is a front top and left side perspective view of a keyboard showing my new design;
 FIG. 2 is a rear, bottom and left side perspective view thereof;
 FIG. 3 is a top plan view thereof on an enlarged scale;
 FIG. 4 is a front elevational view thereof;
 FIG. 5 is a rear elevational view thereof;
 FIG. 6 is a left side elevational view thereof;
 FIG. 7 is a right side elevational view thereof; and,
 FIG. 8 is a bottom plan view thereof.

[56] **References Cited**

U.S. PATENT DOCUMENTS

D. 270,729	9/1983	Lahey et al.	D14/100
D. 278,063	3/1985	Chamberlain	D14/100
D. 279,474	7/1985	Akagi et al.	D14/115
D. 281,246	11/1985	Lenzi	D14/100
D. 284,574	7/1986	Fischer	D14/115
D. 285,561	9/1986	Mack et al.	D14/115
D. 287,972	1/1987	Anzelone et al.	D14/115
D. 288,204	2/1987	Anzelone et al.	D14/115
D. 292,801	11/1987	Davis, Jr. et al.	D14/115

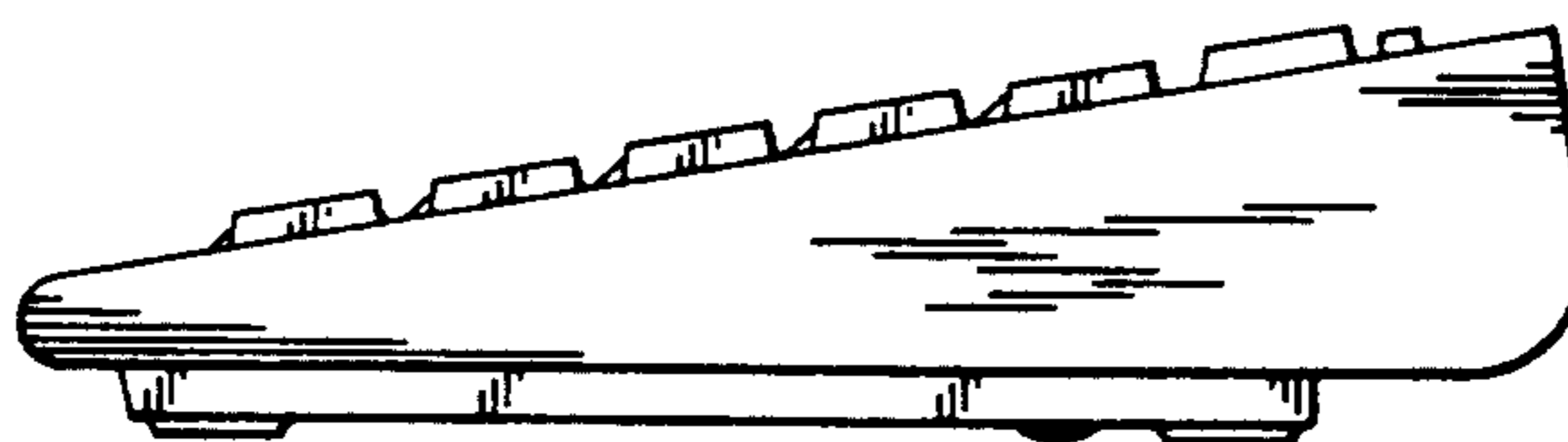
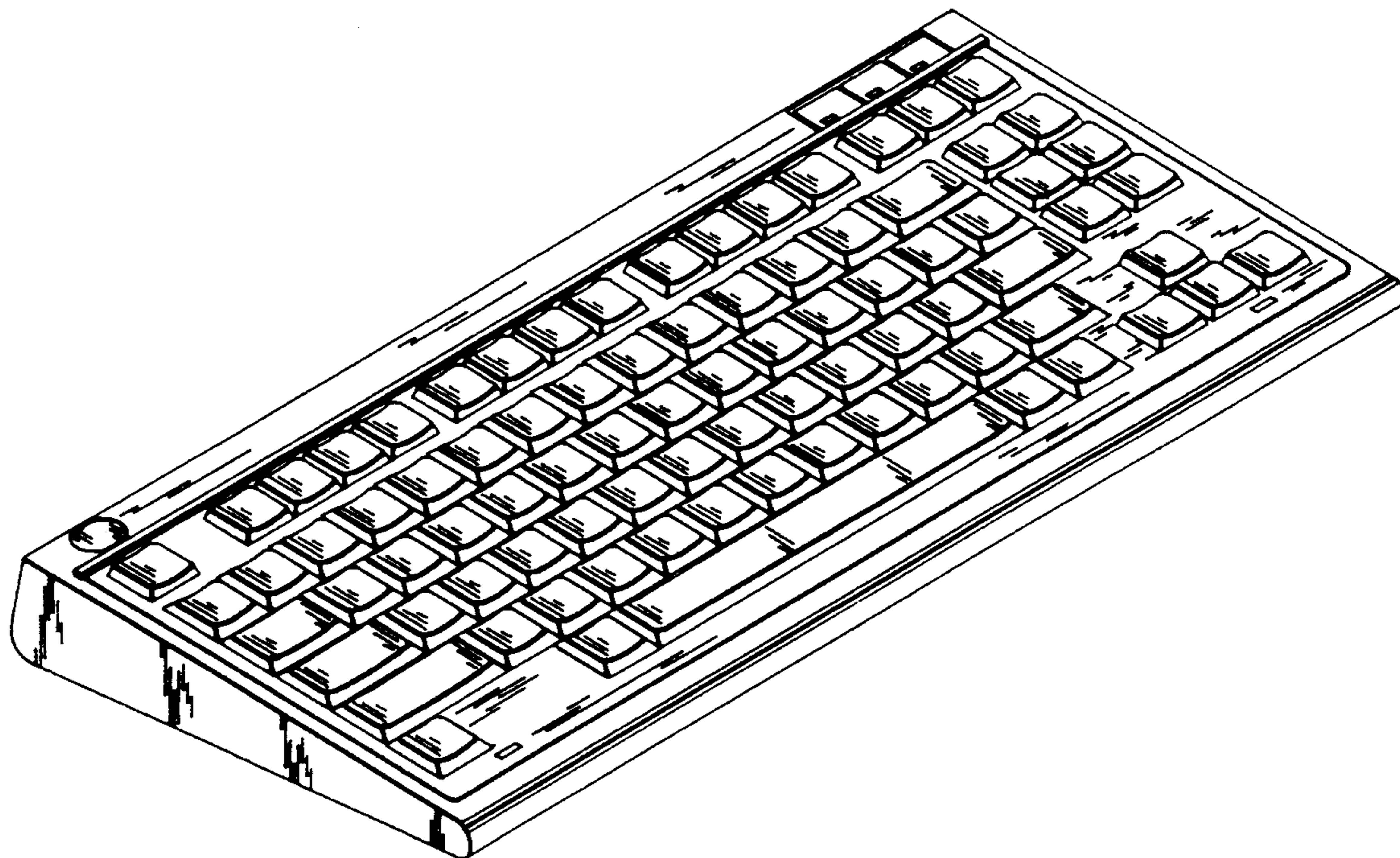

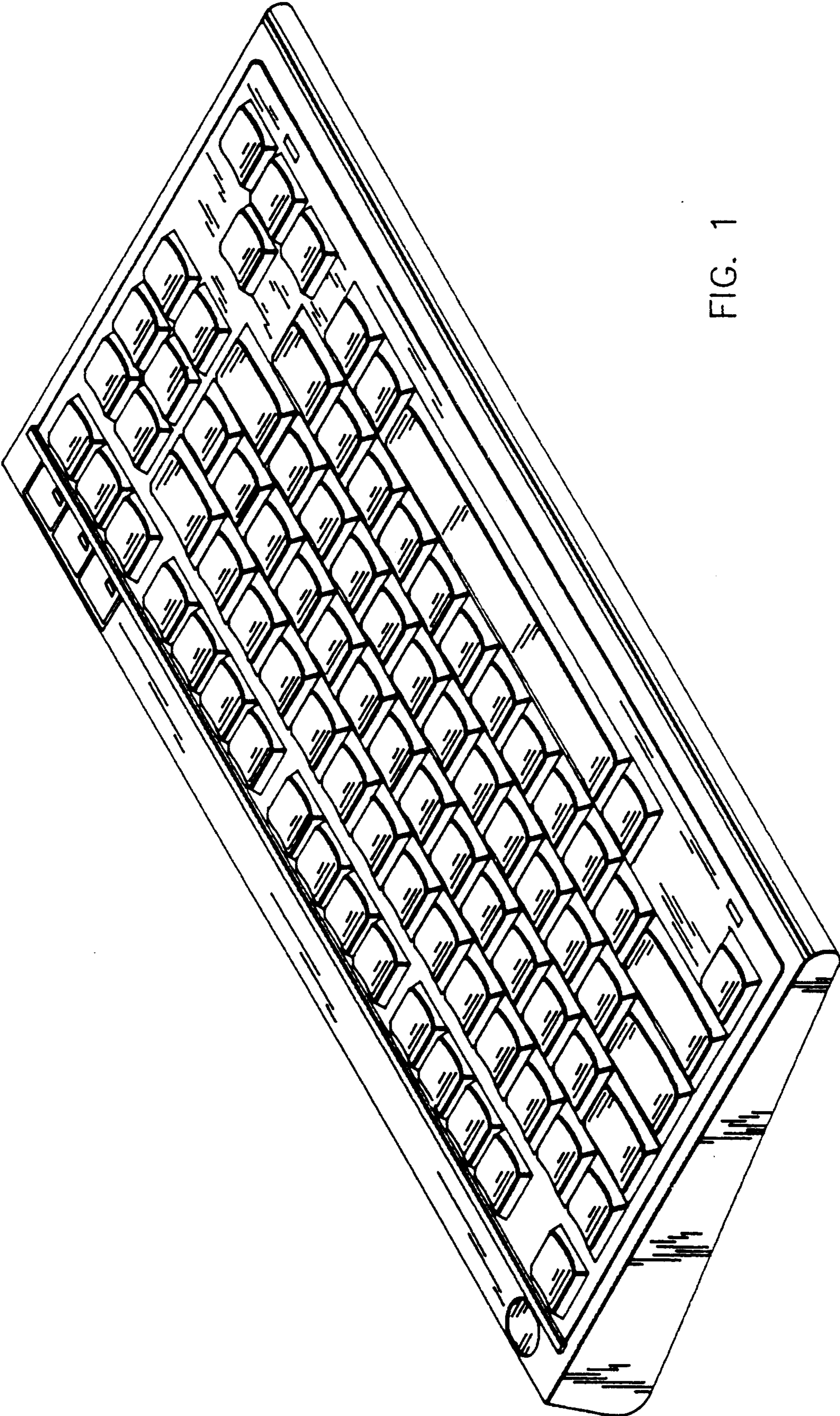

FIG. 1

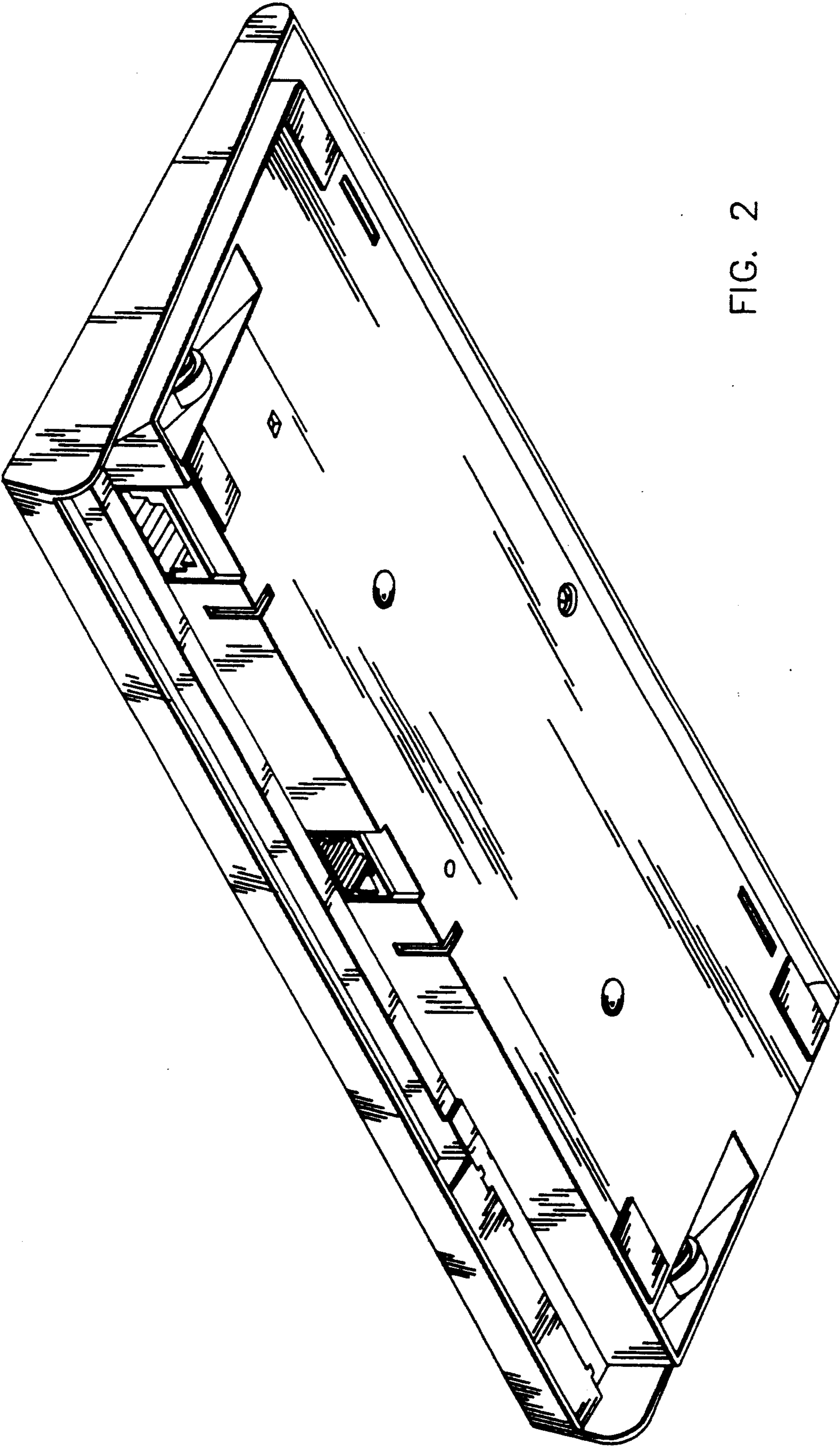

FIG. 2

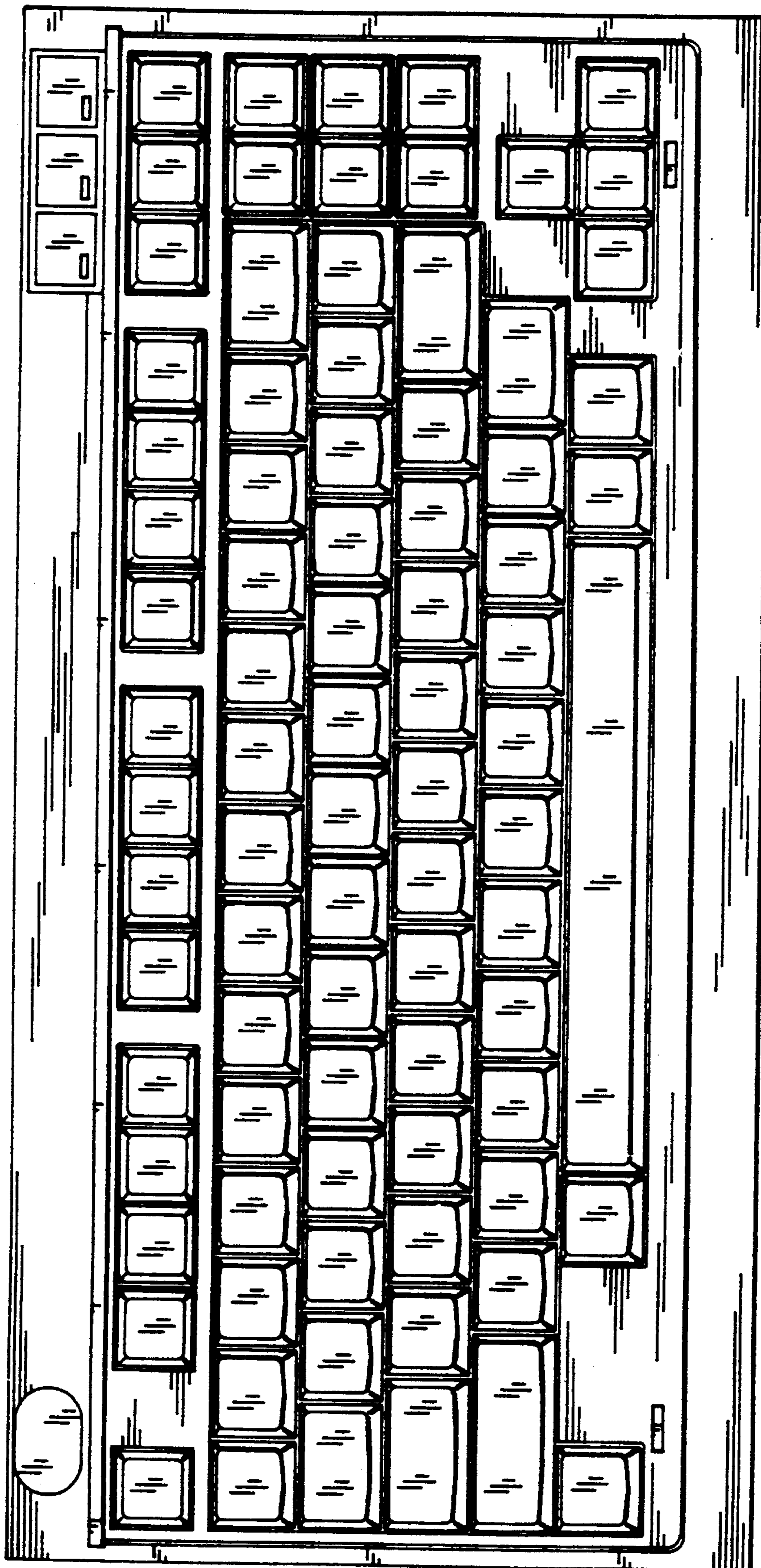

FIG. 3

FIG. 4

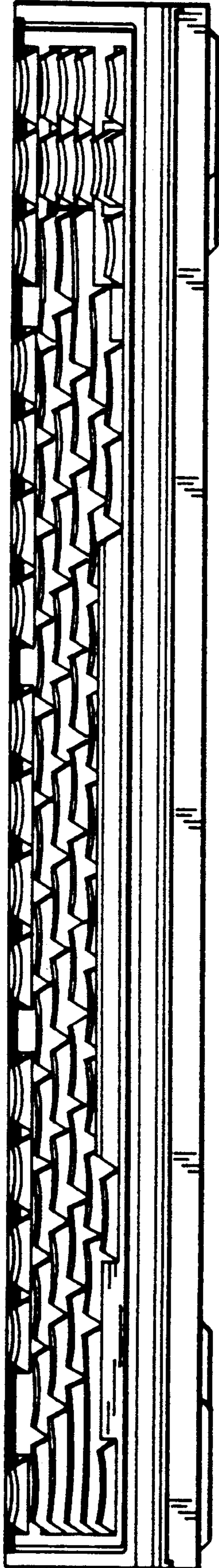

FIG. 5

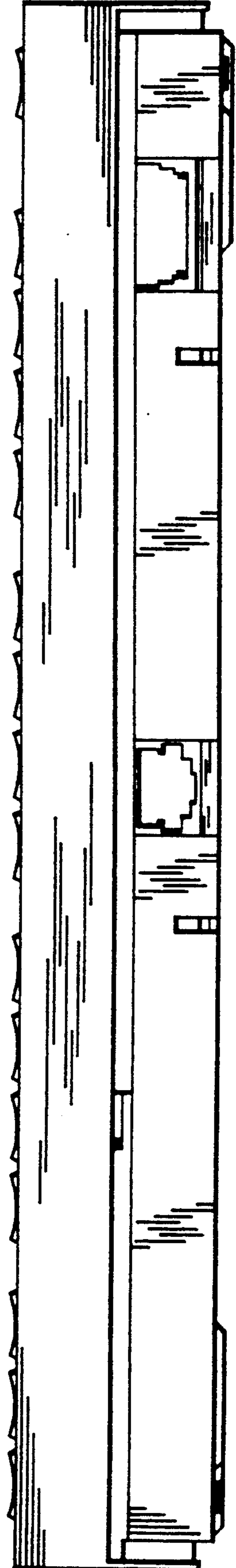

FIG. 6

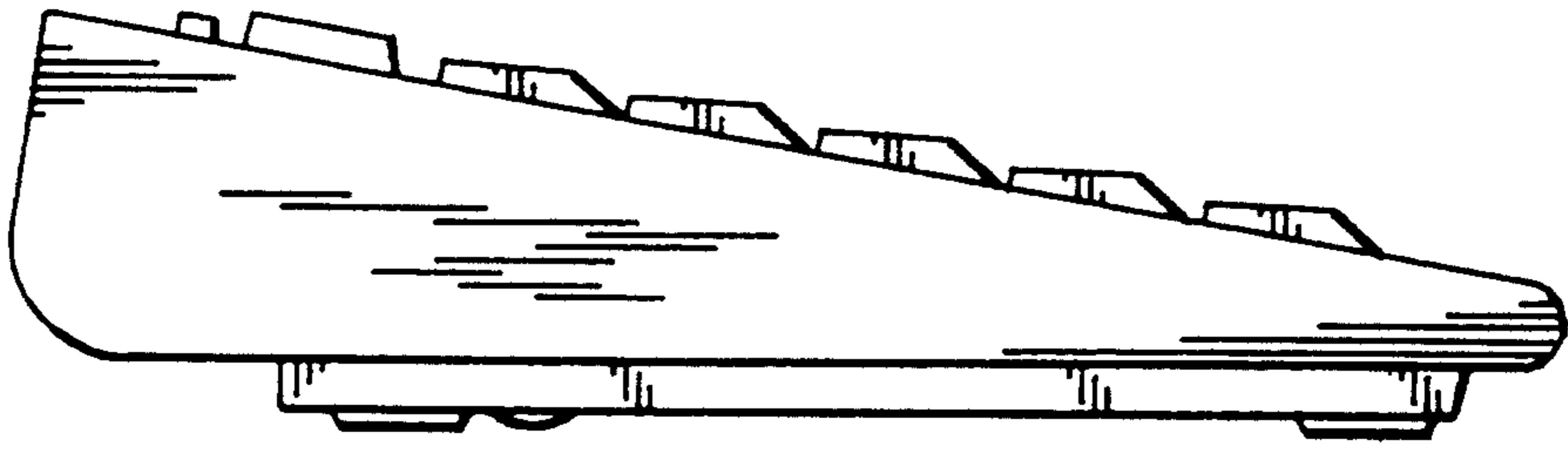
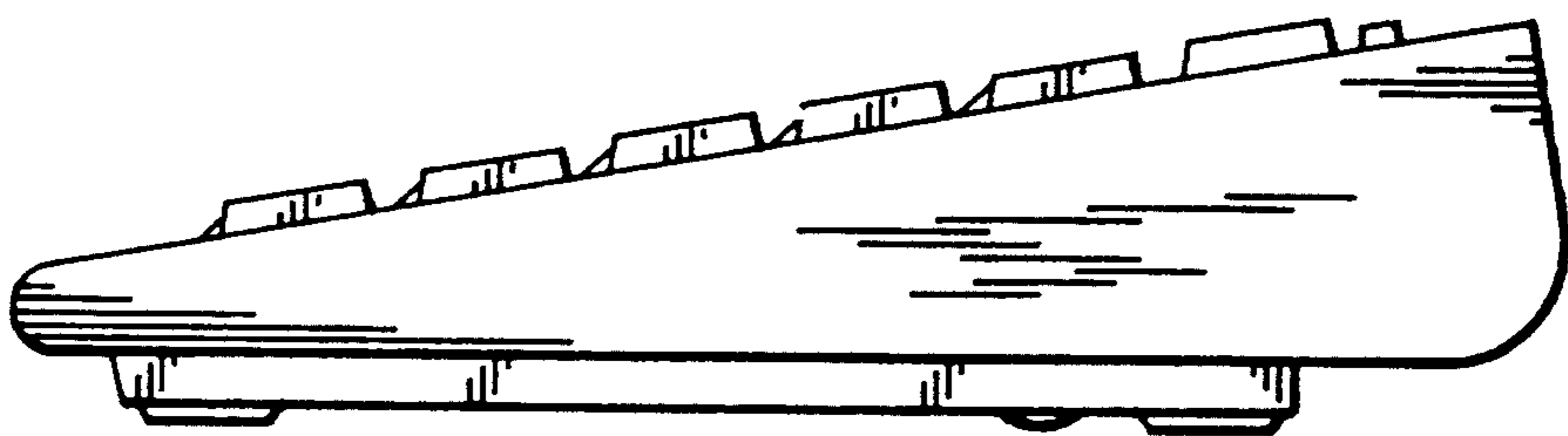

FIG. 7



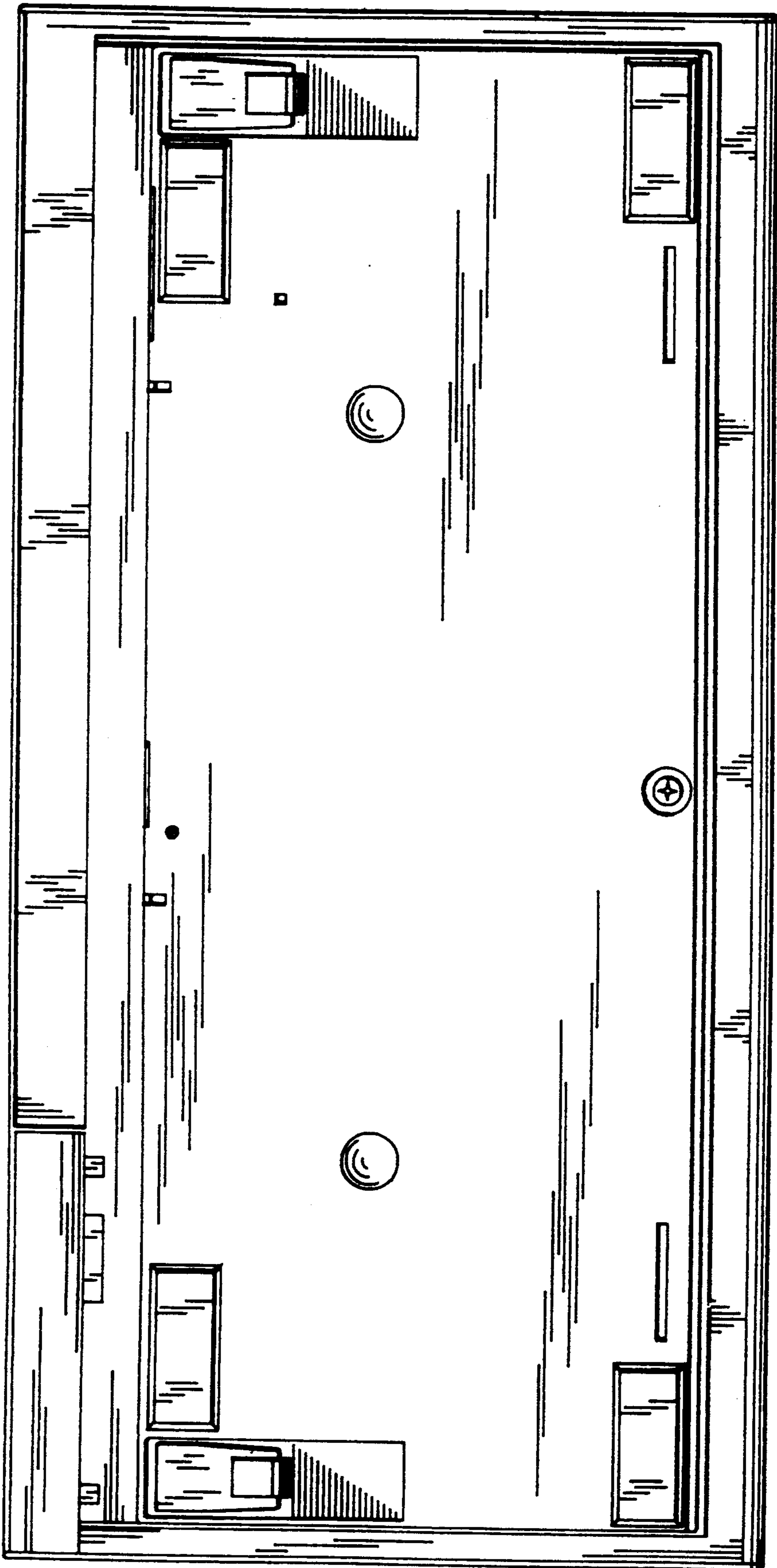

FIG. 8