



US00D344711S

United States Patent [19]

[11] Patent Number: **Des. 344,711**

Clancey et al.

[45] Date of Patent: **** Mar. 1, 1994**

[54] ENCLOSURE FOR AN ENGINE-DRIVEN GENERATING SET

OTHER PUBLICATIONS

[75] Inventors: **Stephen M. Clancey**, Moundsvew; **Dale F. Seeley**, Champlin; **Gary Salmonson**, St. Cloud; **David A. Overland**, Cedar, all of Minn.; **Emilio Ambasz**, New York, N.Y.; **Paul W. Haverly**, Coon Rapids, Minn.; Deceased by **June E. Haverly**, Coon Rapids, Minn., Administrator

Generators on p. 418 of *Hardware Age* Aug.-1988.
Generator on p. 148 of *Hardware Age* May-1989.
Generator on p. 189 of *Hardware Age* Aug.-1989.
Generators on p. 71 of *Hardware Age* Mar.-1989.
Onan Portable Power Brochure (Dec. 1983).
Onan MicroLite® RV GenSets Brochure (Nov. 1987).
Onan MicroLite® Brochure (Mar. 1988).
Onan MicroLite® Brochure (Jun. 1990).
Kohler Brochure (1990).
Honda Brochure (1986).
Honda Brochure (1991).

[73] Assignee: **Onan Corporation**, Minneapolis, Minn.

Primary Examiner—Wallace R. Burke
Assistant Examiner—Joel Sincavage
Attorney, Agent, or Firm—Merchant Gould Smith Edell Welter & Schmidt

[**] Term: **14 Years**

[21] Appl. No.: **792,760**

[57] CLAIM

[22] Filed: **Nov. 15, 1991**

The ornamental design for enclosure for an engine-driven generating set, as shown and described.

[52] U.S. Cl. **D13/114**

[58] Field of Search 290/1 A, 1 B; 123/2, 123/3, 198 E; D13/112, 114, 115, 116

DESCRIPTION

[56] References Cited

U.S. PATENT DOCUMENTS

D. 303,785	10/1989	Waltz et al.	D13/114
D. 309,288	7/1990	Haverly	D13/114
4,835,405	5/1989	Clancey et al.	290/1 A
5,076,247	12/1991	Schmidt et al.	290/1 A

FIG. 1 is a front perspective view of the enclosure for an engine-driven generating set showing our new design;
FIG. 2 is a front elevational view thereof;
FIG. 3 is a rear elevational view thereof;
FIG. 4 is a left side elevational view thereof;
FIG. 5 is a right side elevational view thereof;
FIG. 6 is a top plan view thereof; and,
FIG. 7 is a bottom plan view thereof.

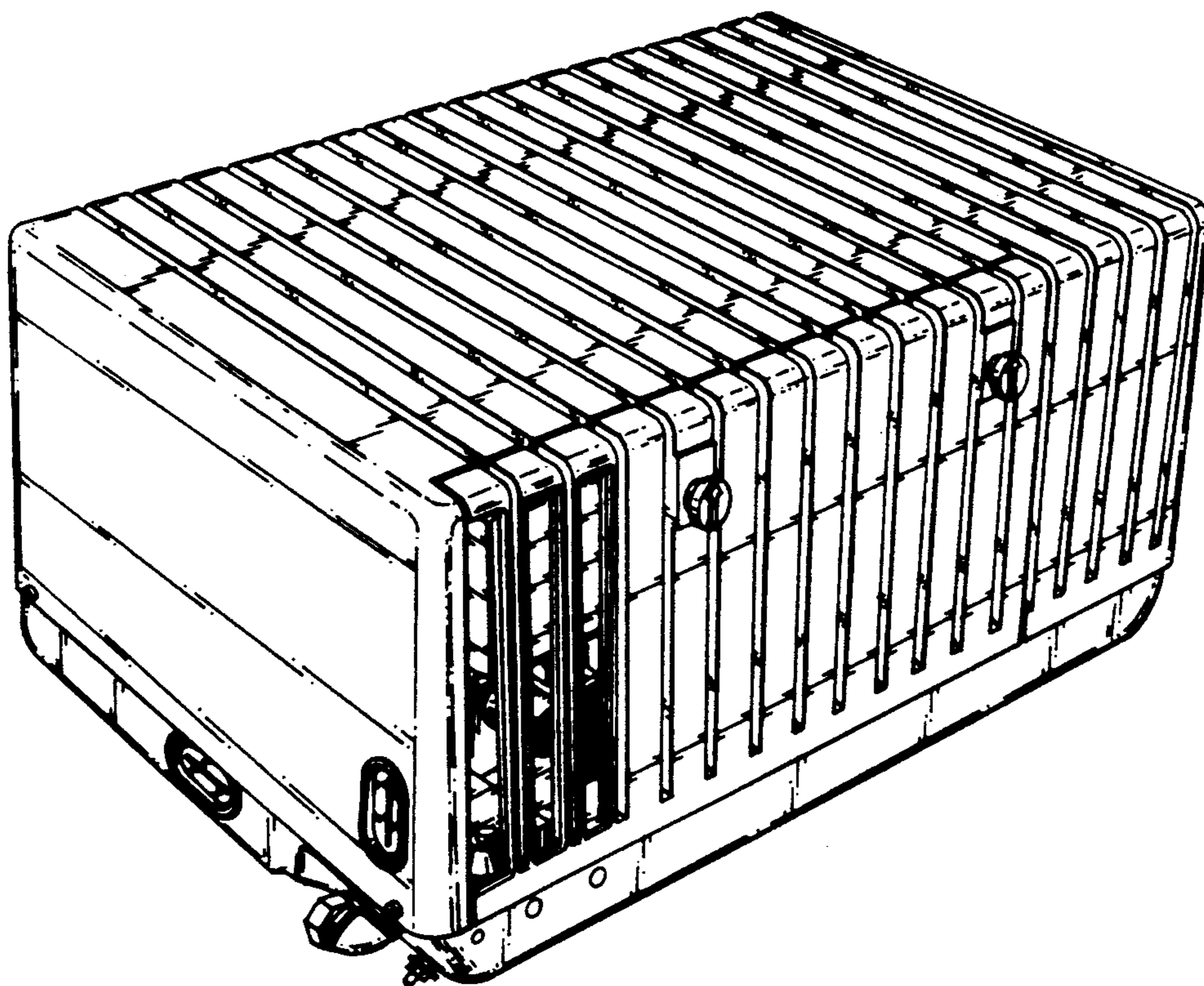

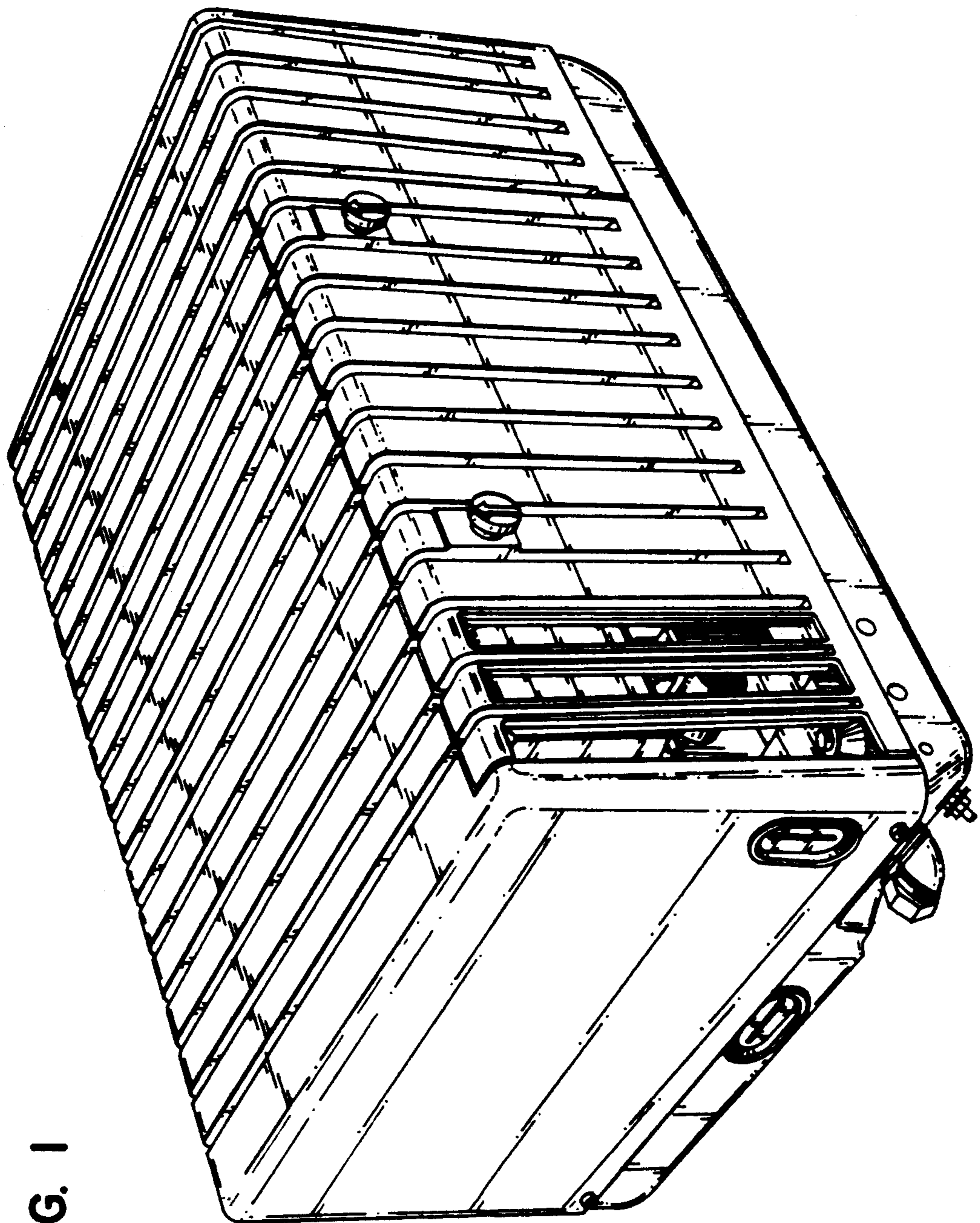
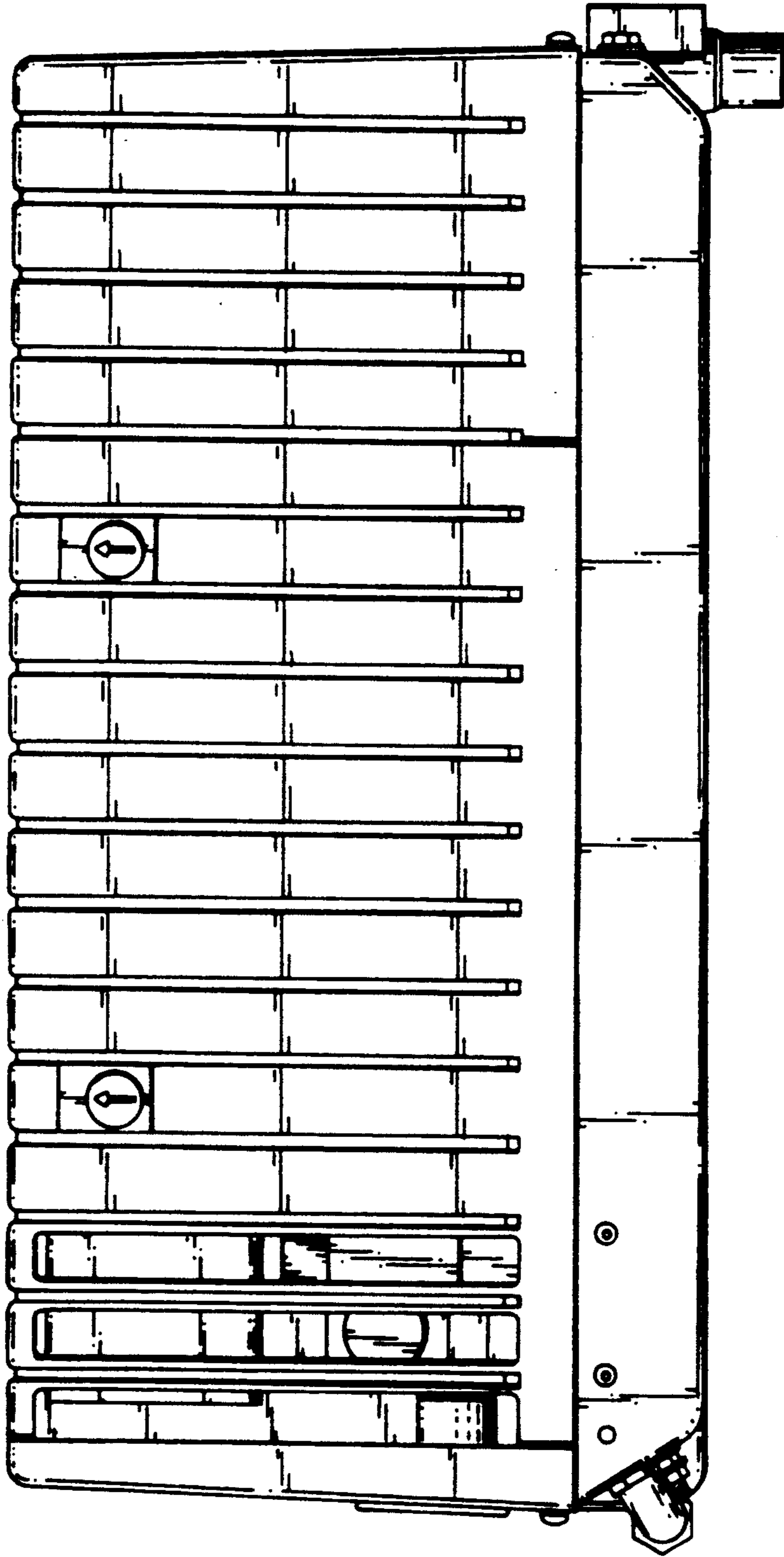

FIG. 1

FIG. 2



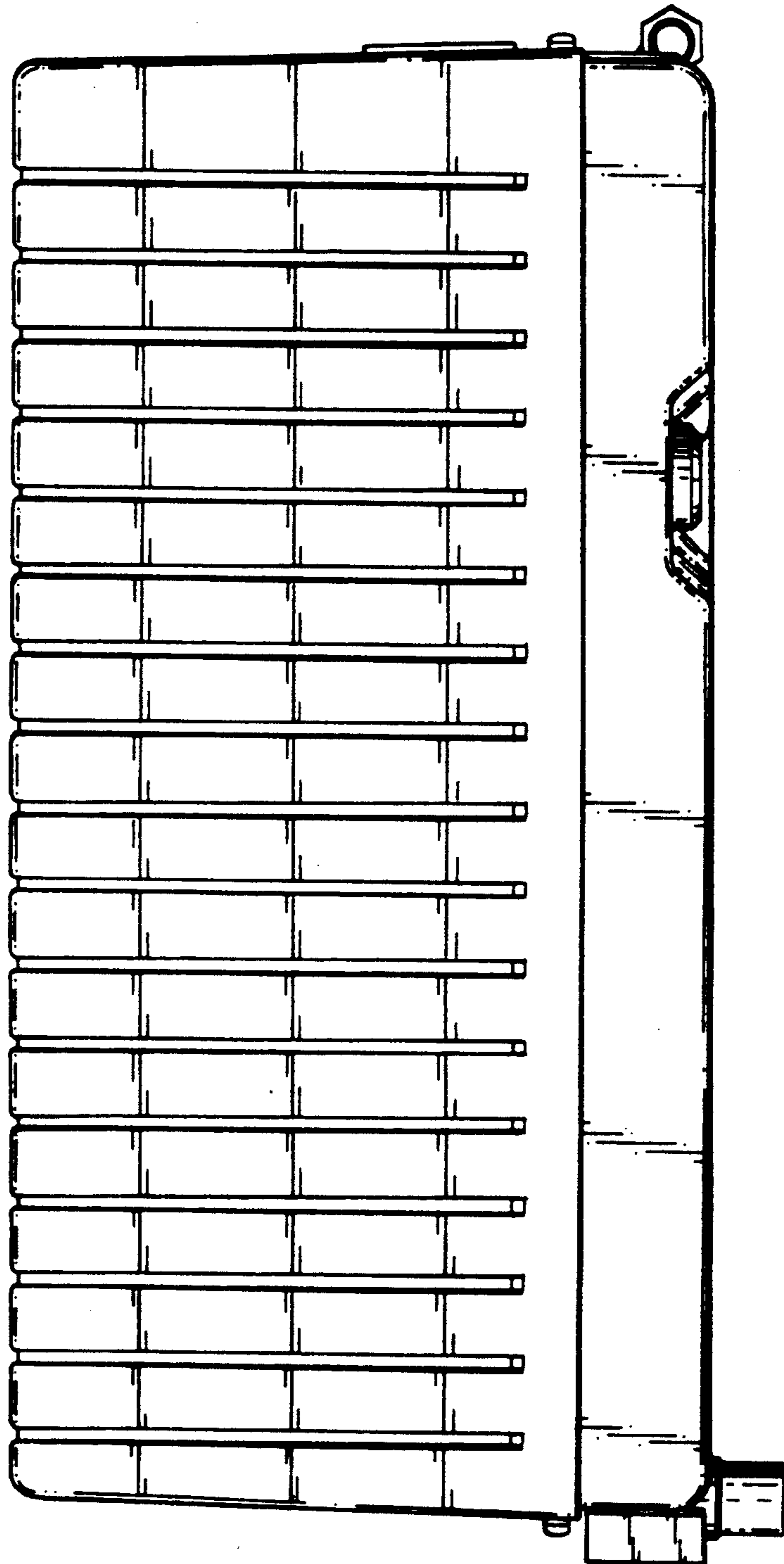

FIG. 3

FIG. 4

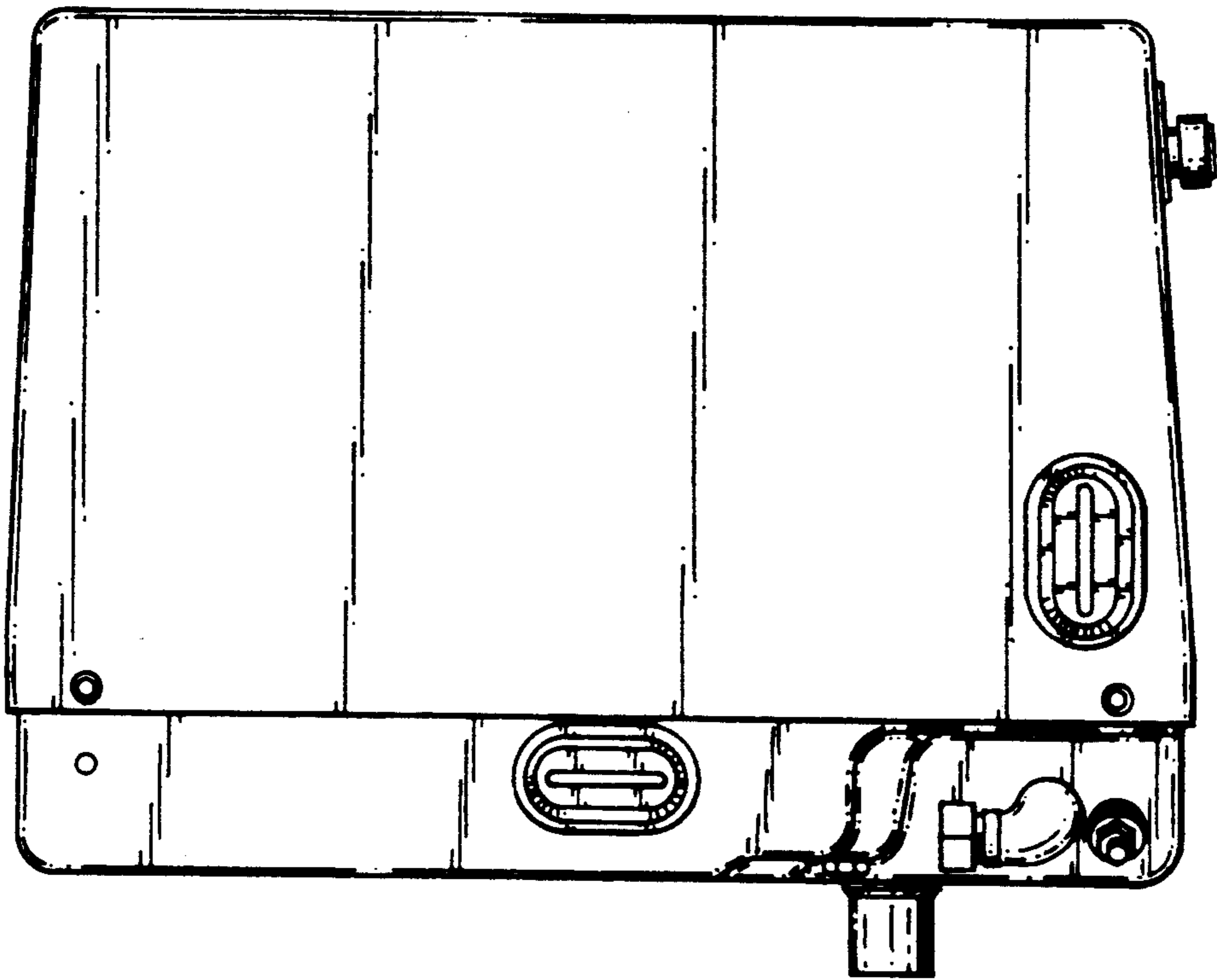
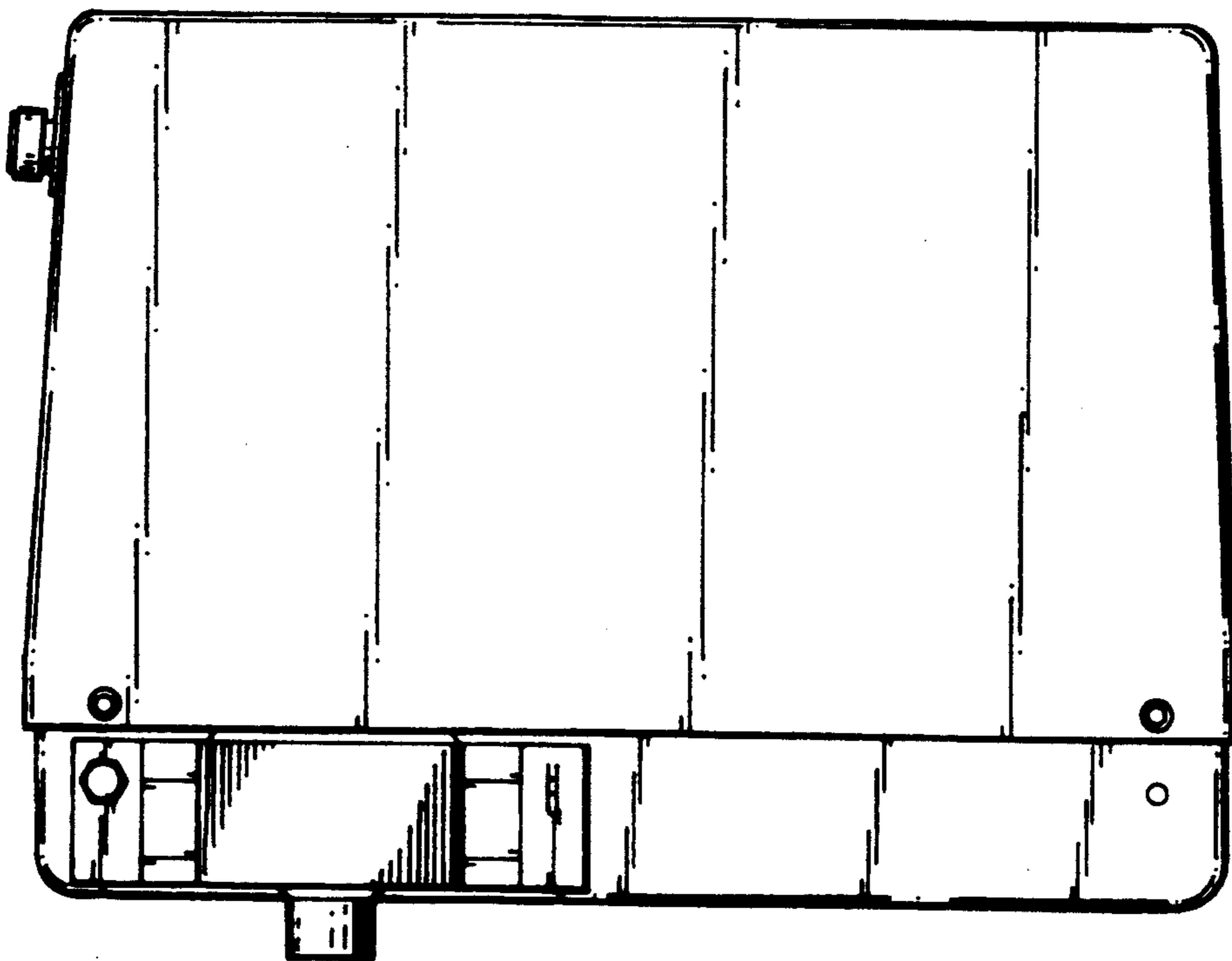

FIG. 5



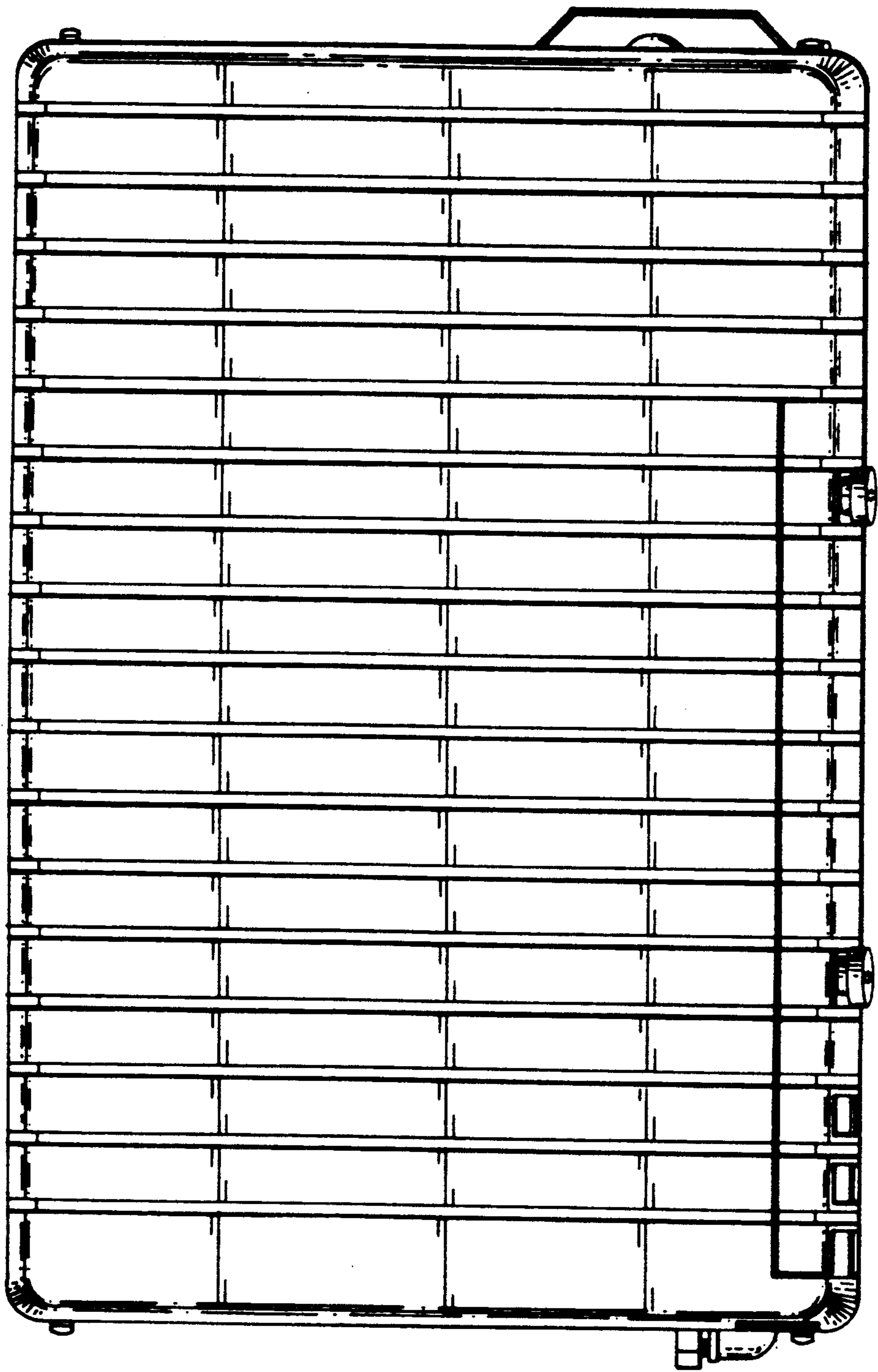

FIG. 6

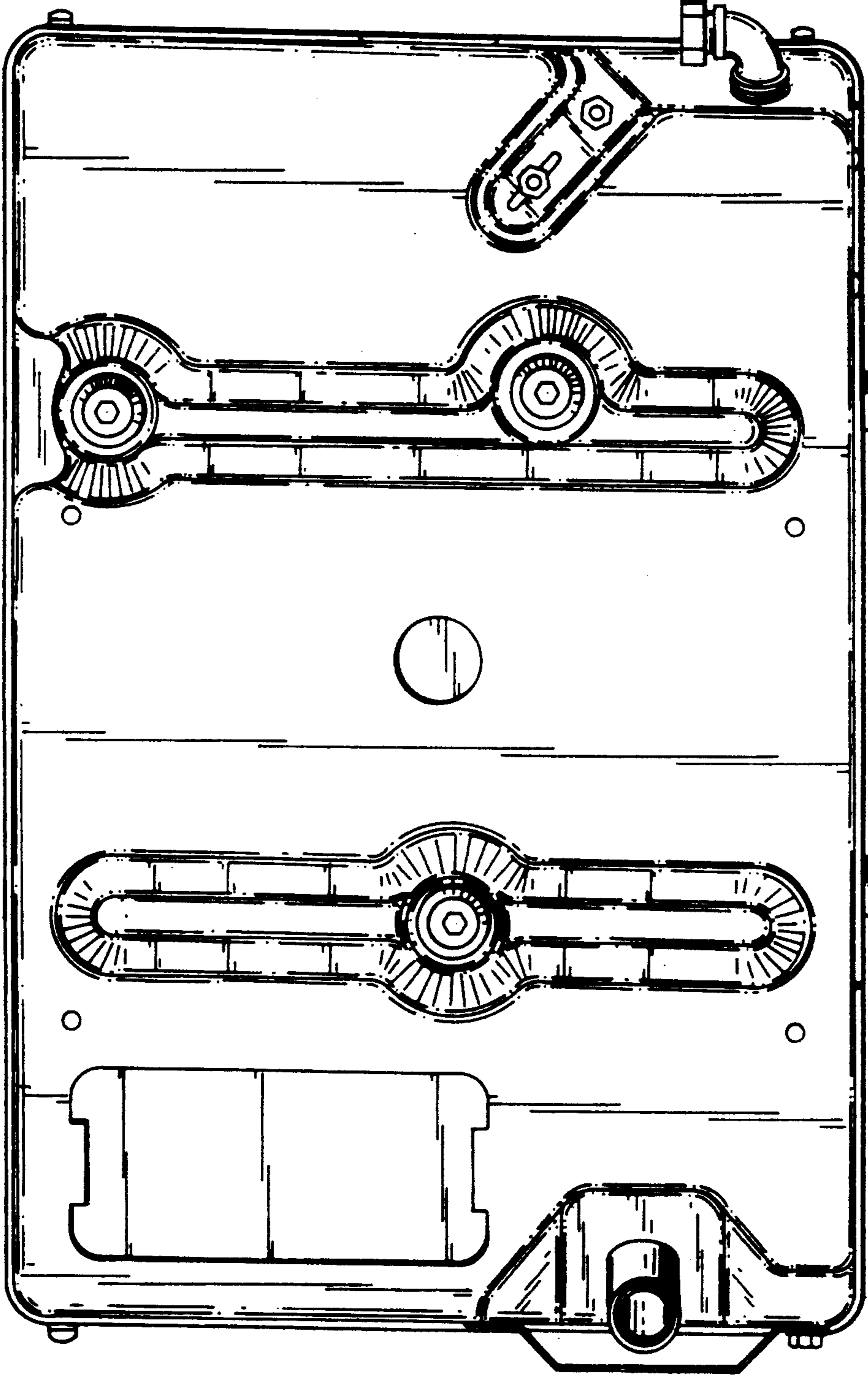

FIG. 7