



US00D344676S

United States Patent [19]
Newman

[11] **Patent Number: Des. 344,676**
[45] **Date of Patent: ** Mar. 1, 1994**

[54] **WATCH BOX**

[75] **Inventor: Martin Newman, New Rochelle, N.Y.**

[73] **Assignee: Gruen Marketing Corporation, Exeter, Pa.**

[**] **Term: 14 Years**

[21] **Appl. No.: 756,777**

[22] **Filed: Sep. 6, 1991**

[52] **U.S. Cl. D9/430; D9/423**

[58] **Field of Search D9/423, 424, 430, 432, D9/414, 337; 206/566, 594, 524.3, 301, 18, 6.1, 45.19, 45.13, 45.14, 45.18; 224/903**

[56] **References Cited**

U.S. PATENT DOCUMENTS

D. 151,956	12/1948	Baud	D9/423
D. 244,123	4/1977	Shiffman	D9/423
D. 259,398	6/1981	Shiffman	D9/423
D. 332,399	1/1993	Neff	D9/423
D. 332,400	1/1993	Neff	D9/423
2,041,303	5/1936	Shields	206/566 X
4,732,269	3/1988	Roy	206/45.13

OTHER PUBLICATIONS

Jewelers Circular Keystone, 1985 Rocket Boxes p. 3, Item #35LP.

Packaging, 1959, p. 167, Item #519.

Packaging, 1959, p. 164, Item #507.

Jeweler's Circular Keystone, Jun. 1975, p. 58 Item T311W.

Primary Examiner—Prabhakar G. Deshmukh
Attorney, Agent, or Firm—Steven H. Bazerman

[57] **CLAIM**

The ornamental design for a watch box, as shown and described.

DESCRIPTION

FIG. 1 is a perspective view of a watch box showing my new design;

FIG. 2 is a top plan view thereof;

FIG. 3 is a front elevational view thereof;

FIG. 4 is a left side elevational view thereof; the right side elevational view being a mirror image thereof;

FIG. 5 is a rear elevational view thereof;

FIG. 6 is a bottom plan view thereof;

FIG. 7 is a perspective view thereof; shown in a closed position; and,

FIG. 8 is a perspective view of a second embodiment of FIG. 1.

The corresponding views disclosed in the second embodiment (FIG. 8) are similar to the first embodiment (FIGS. 2-7 inclusive).

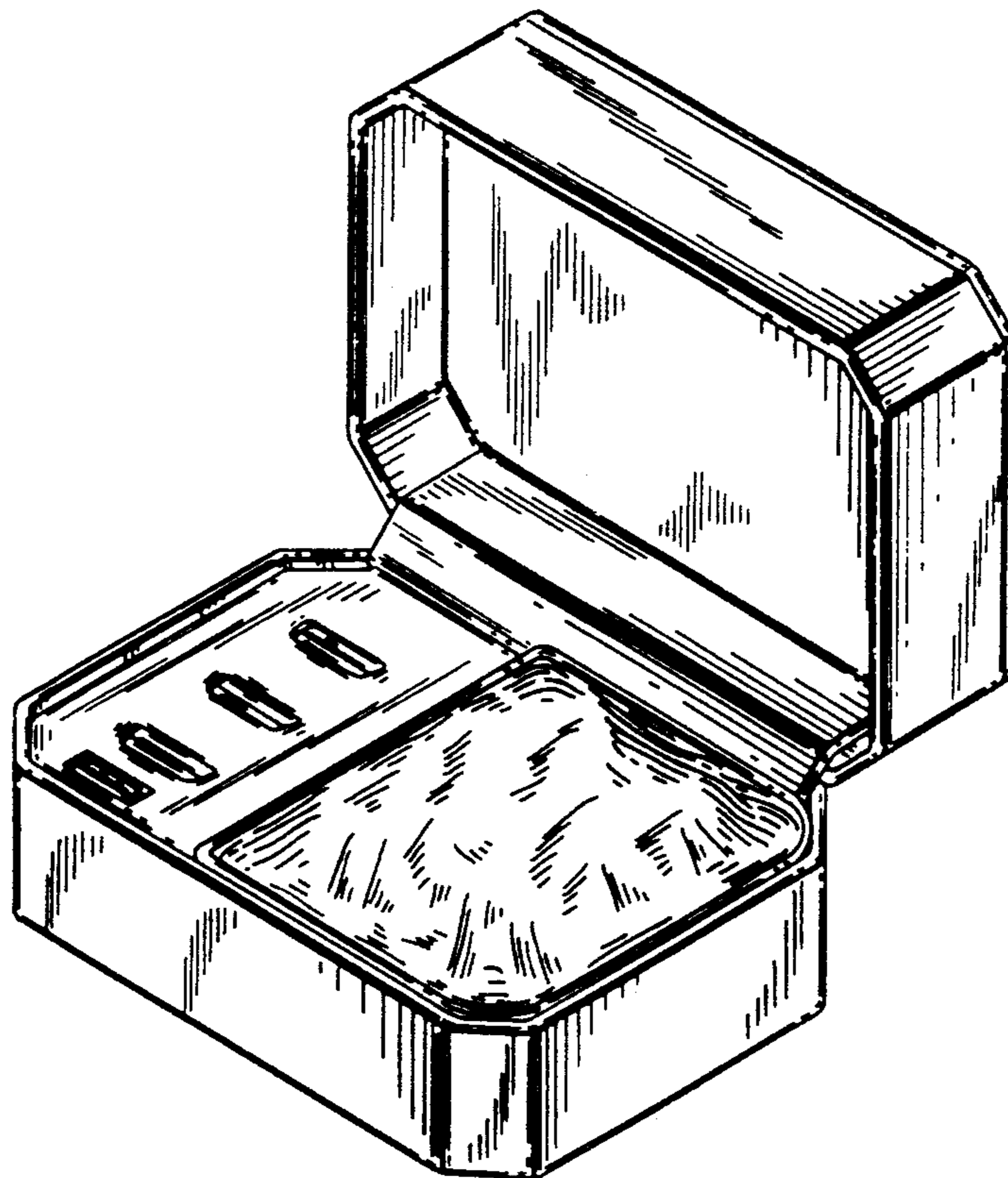

FIG. 1

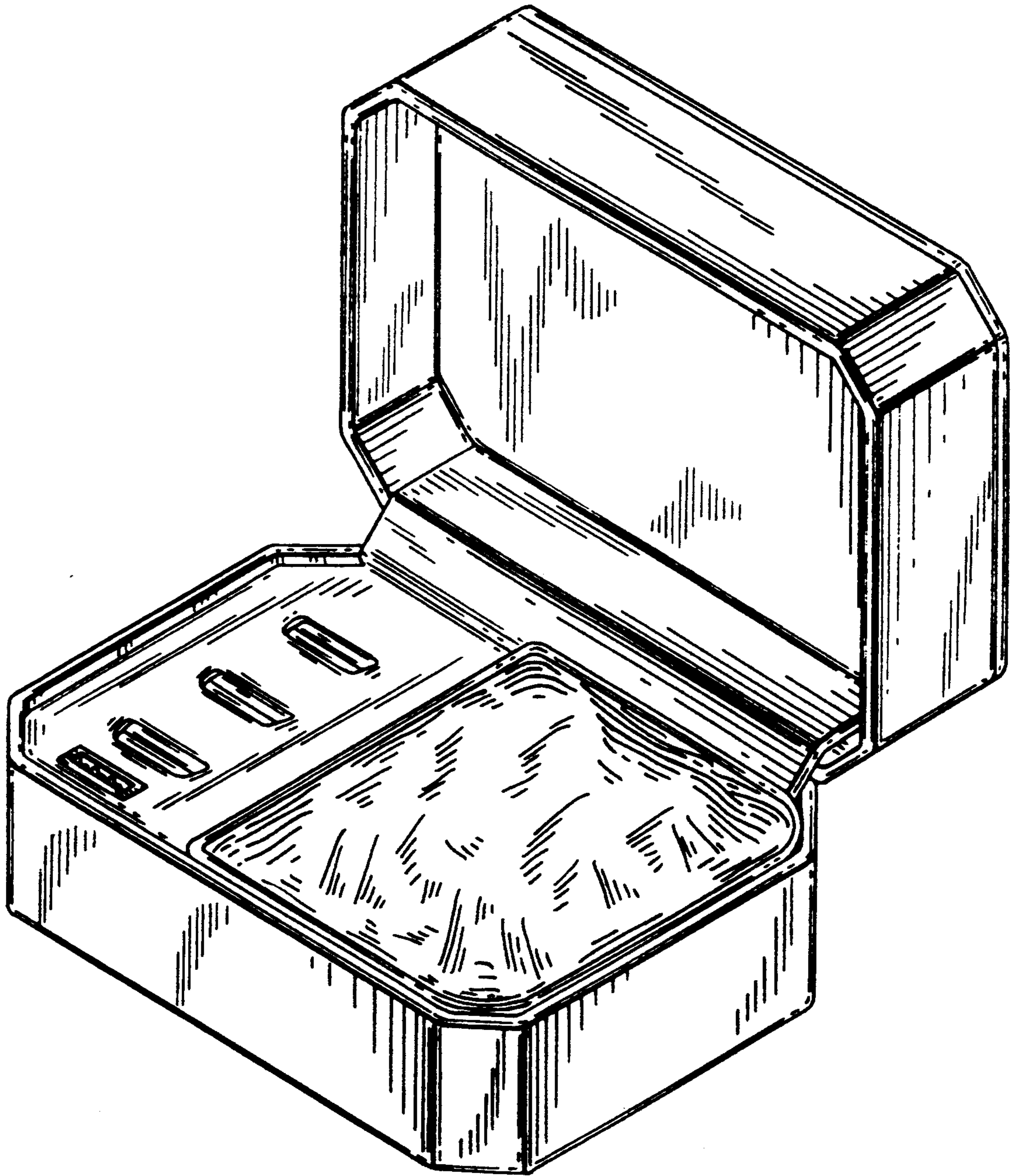

FIG. 2

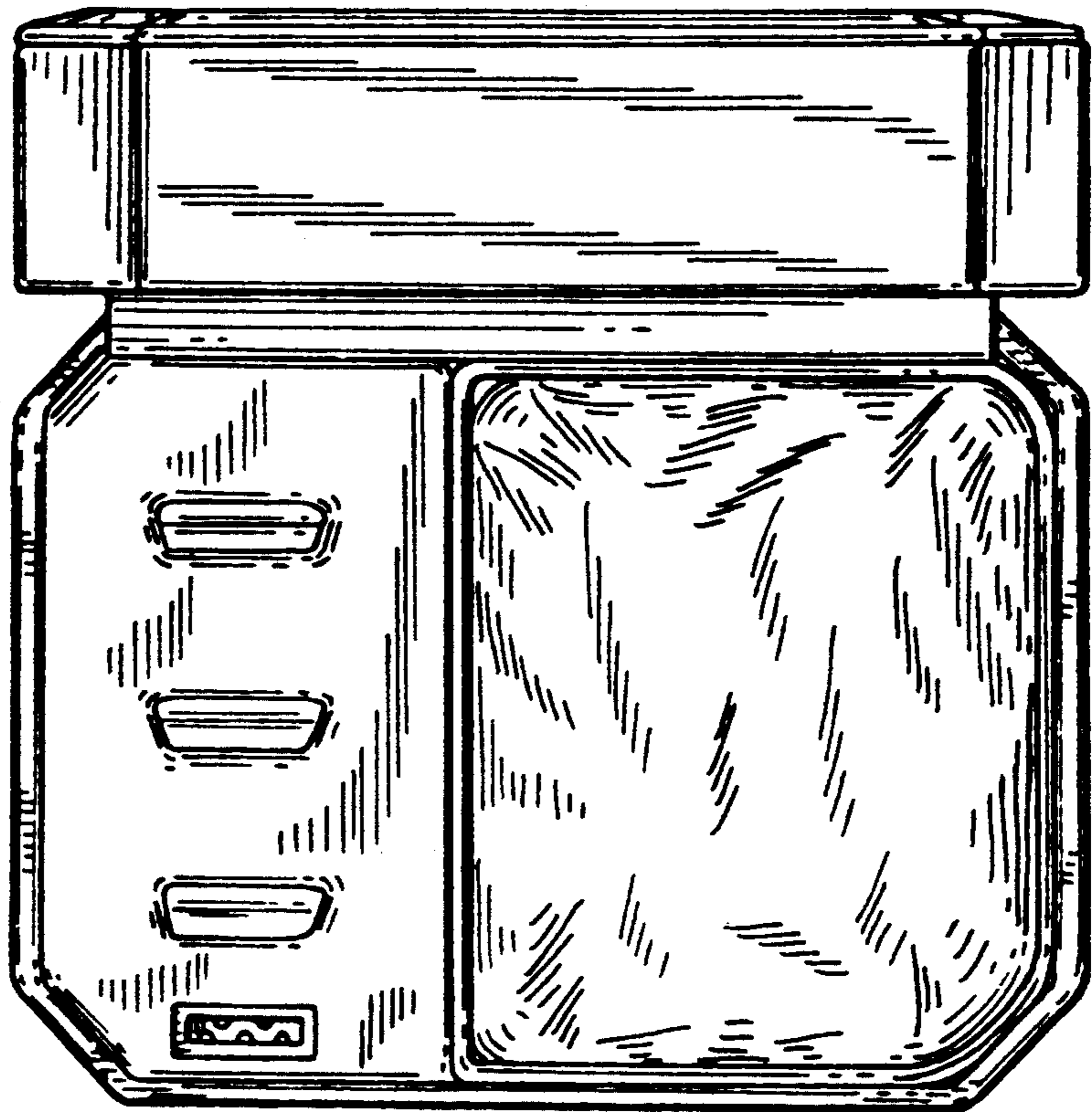

FIG. 3

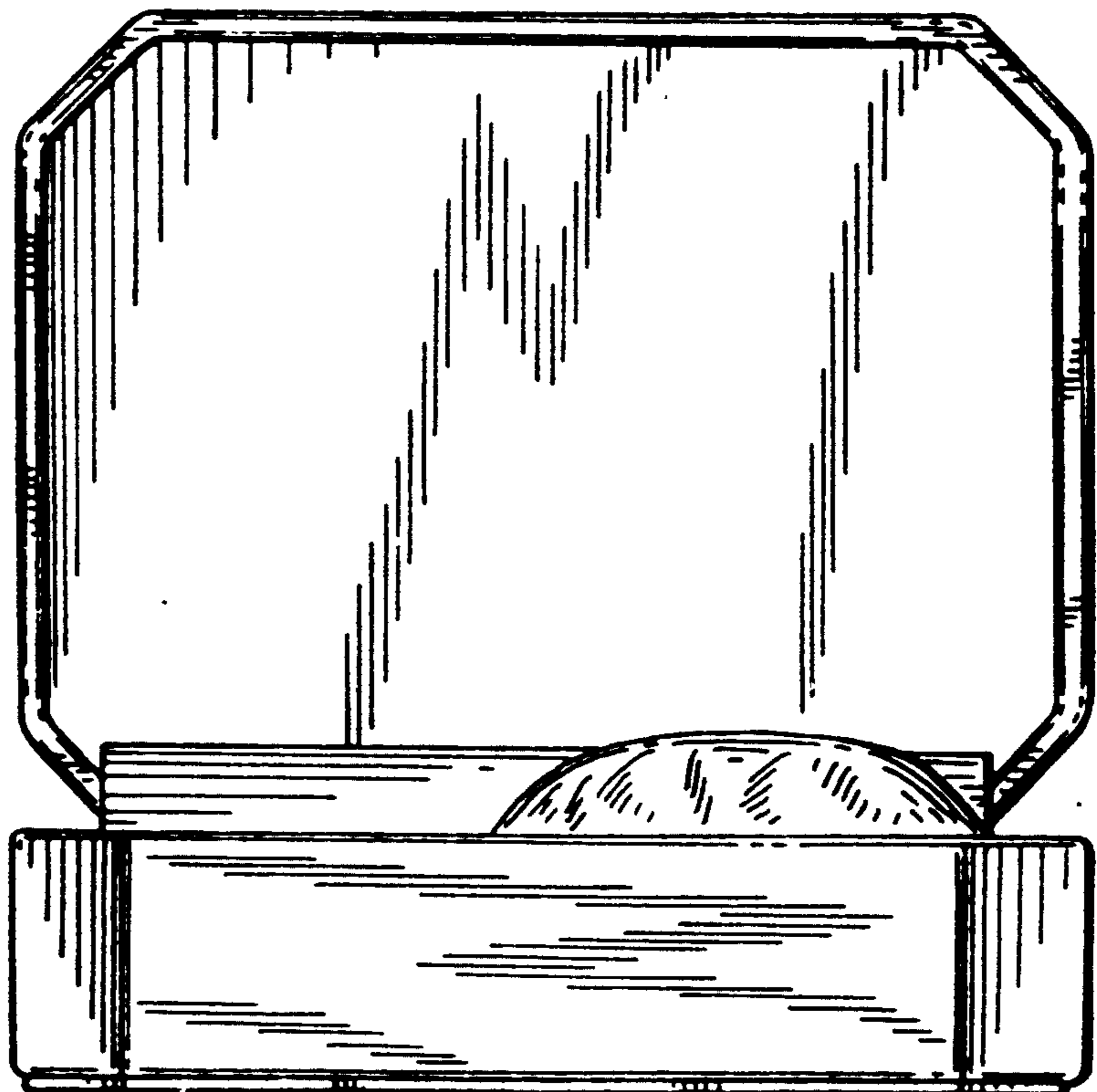

FIG. 5

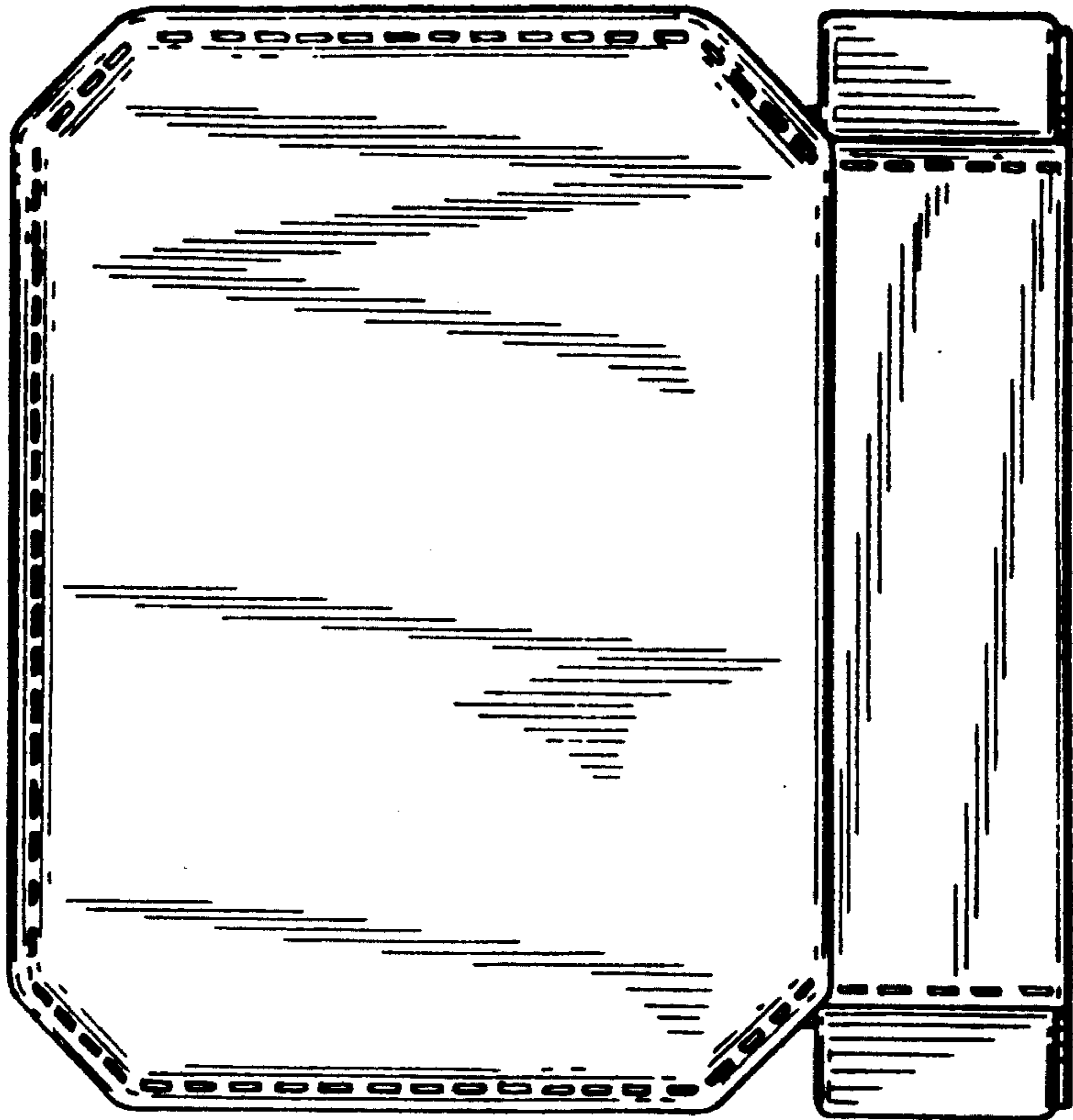

FIG. 4

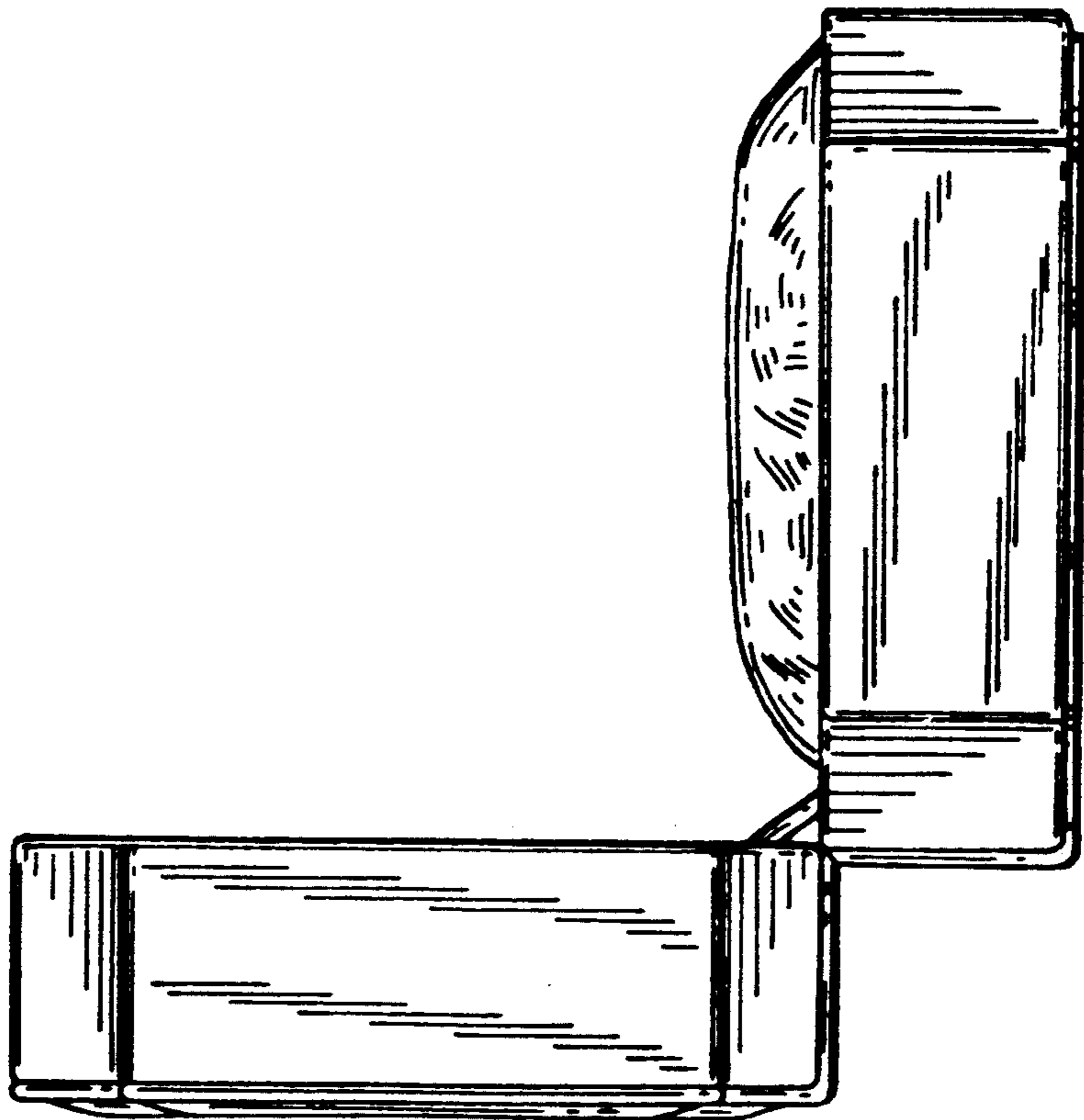

FIG. 6

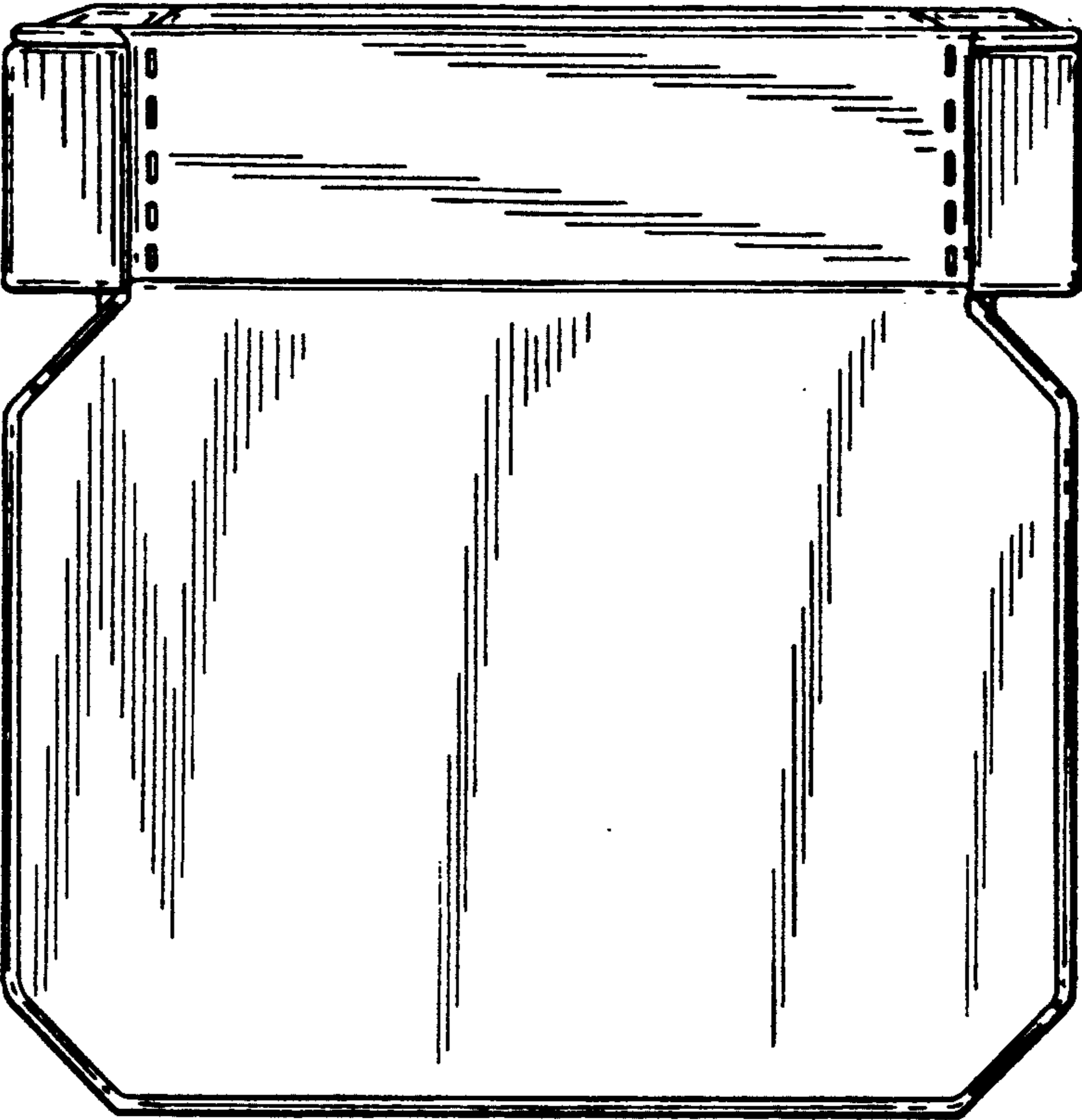

FIG. 7

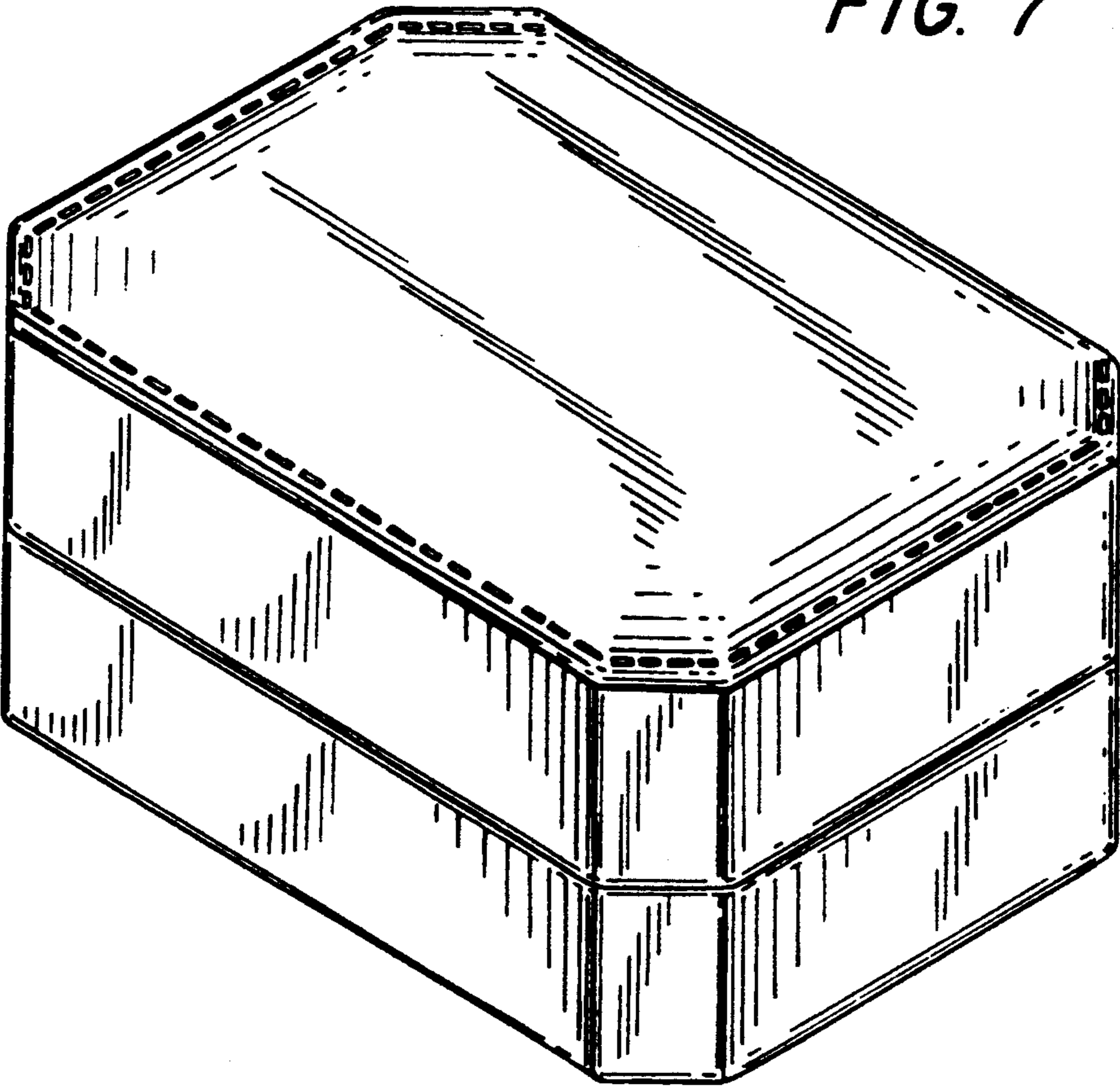

FIG. 8

