



US00D344639S

United States Patent [19]

[11] Patent Number: **Des. 344,639**

Evans, Jr.

[45] Date of Patent: **** Mar. 1, 1994**

[54] **BUILT IN BABY/CHILD CAR SEAT**

4,693,511	9/1987	Seltzer et al.	297/219
4,722,568	2/1988	Irvin	297/238
5,161,855	11/1992	Harman	297/391 X

[76] Inventor: **Leroy H. Evans, Jr.**, 363 E. Commerce St.-Apt. 508, Smyrna, Del. 19977

Primary Examiner—Nelson C. Holtje
Assistant Examiner—J. E. Seeger
Attorney, Agent, or Firm—S. Michael Bender

[**] Term: **14 Years**

[21] Appl. No.: **813,409**

[57] **CLAIM**

[22] Filed: **Dec. 30, 1991**

The ornamental design for a built in baby/child car seat, as shown and described.

[52] U.S. Cl. **D6/333**

[58] Field of Search D6/333, 339, 390-392, D6/364, 365; 297/232, 237, 238, 250, 253, 254, 219, 391

DESCRIPTION

FIG. 1 is a front elevational view of the built in baby/child car seat showing my new design; FIG. 2 is a rear elevational view thereof; FIG. 3 is a left side elevational view thereof; FIG. 4 is a right side elevational view thereof; FIG. 5 is a top plan view thereof; FIG. 6 is a bottom plan view thereof; and, FIG. 7 is an isometric view thereof.

[56] **References Cited**

U.S. PATENT DOCUMENTS

D. 193,058	6/1962	Hunter	D6/345
4,540,216	9/1985	Hassel, Sr.	297/238
4,664,443	5/1987	Casale	297/238

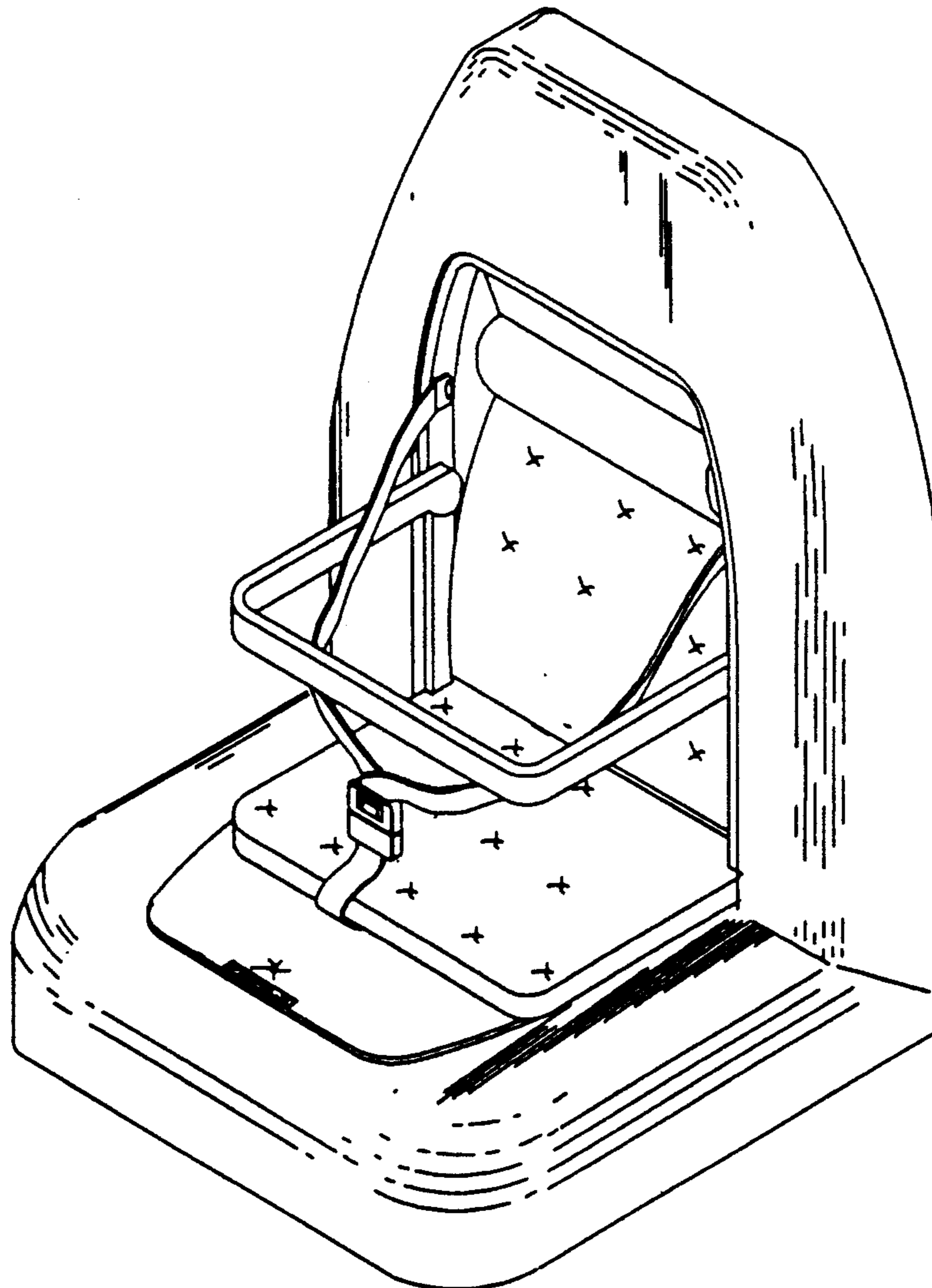

FIG. 1

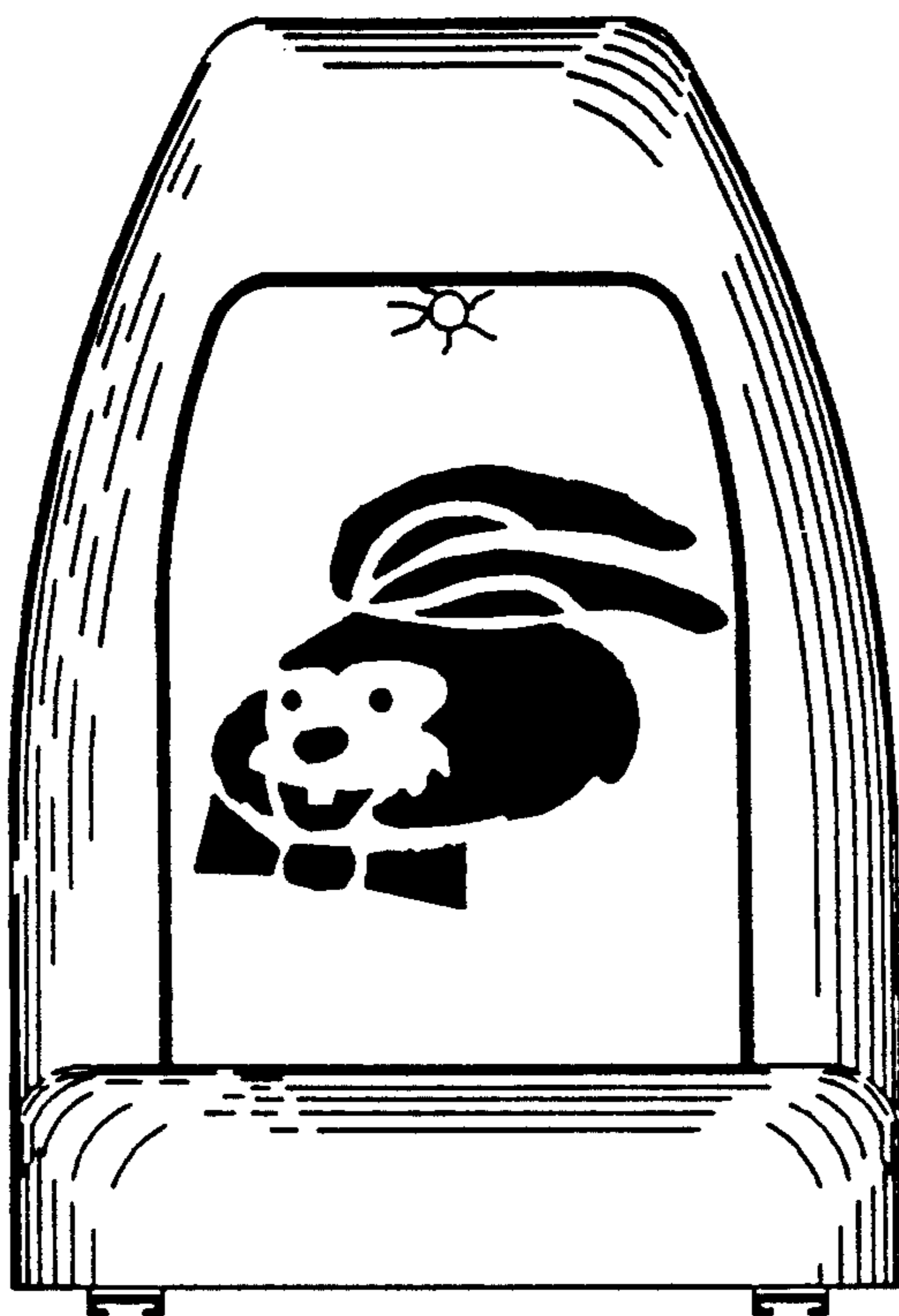

FIG. 2

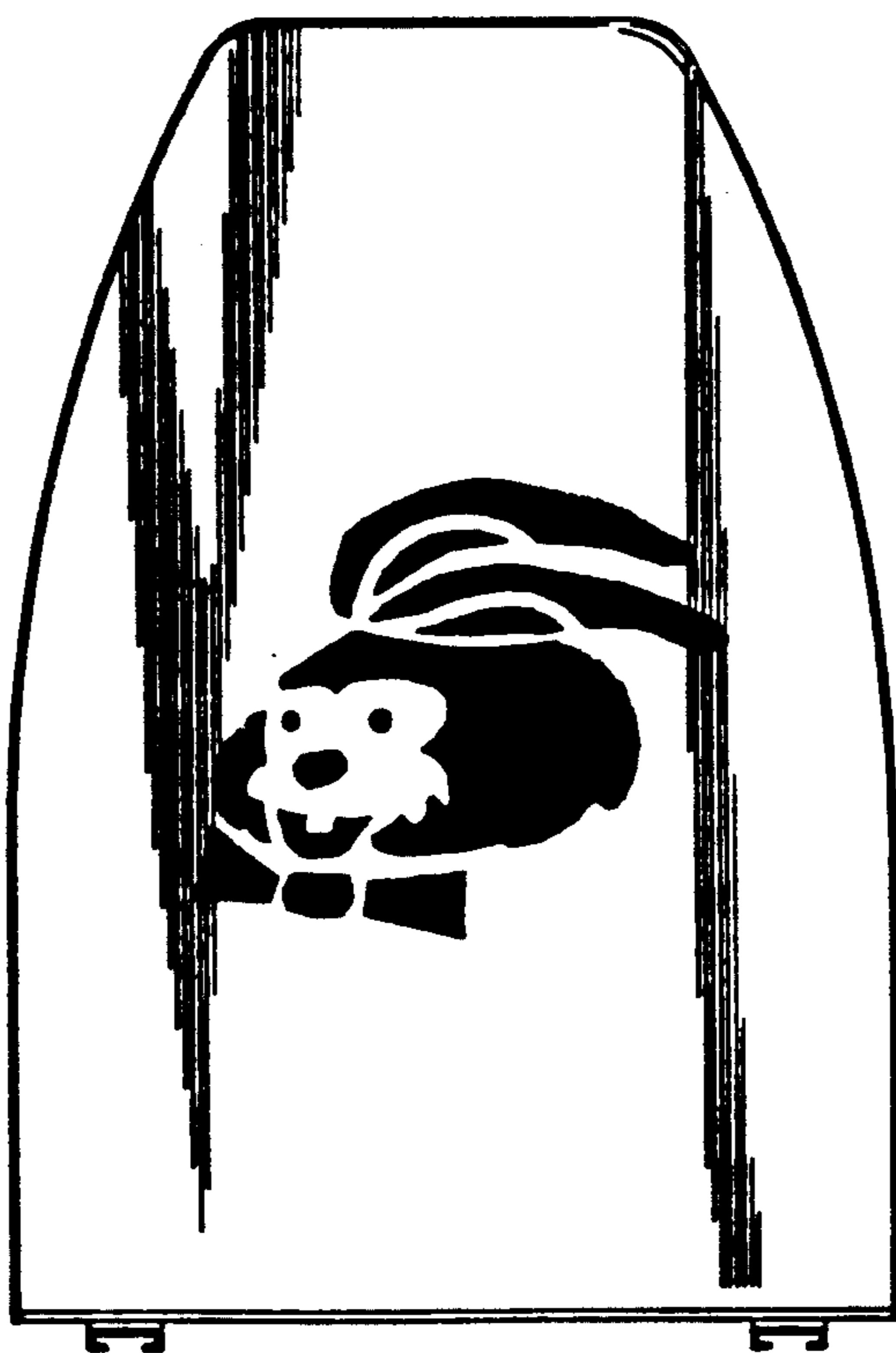

FIG. 3

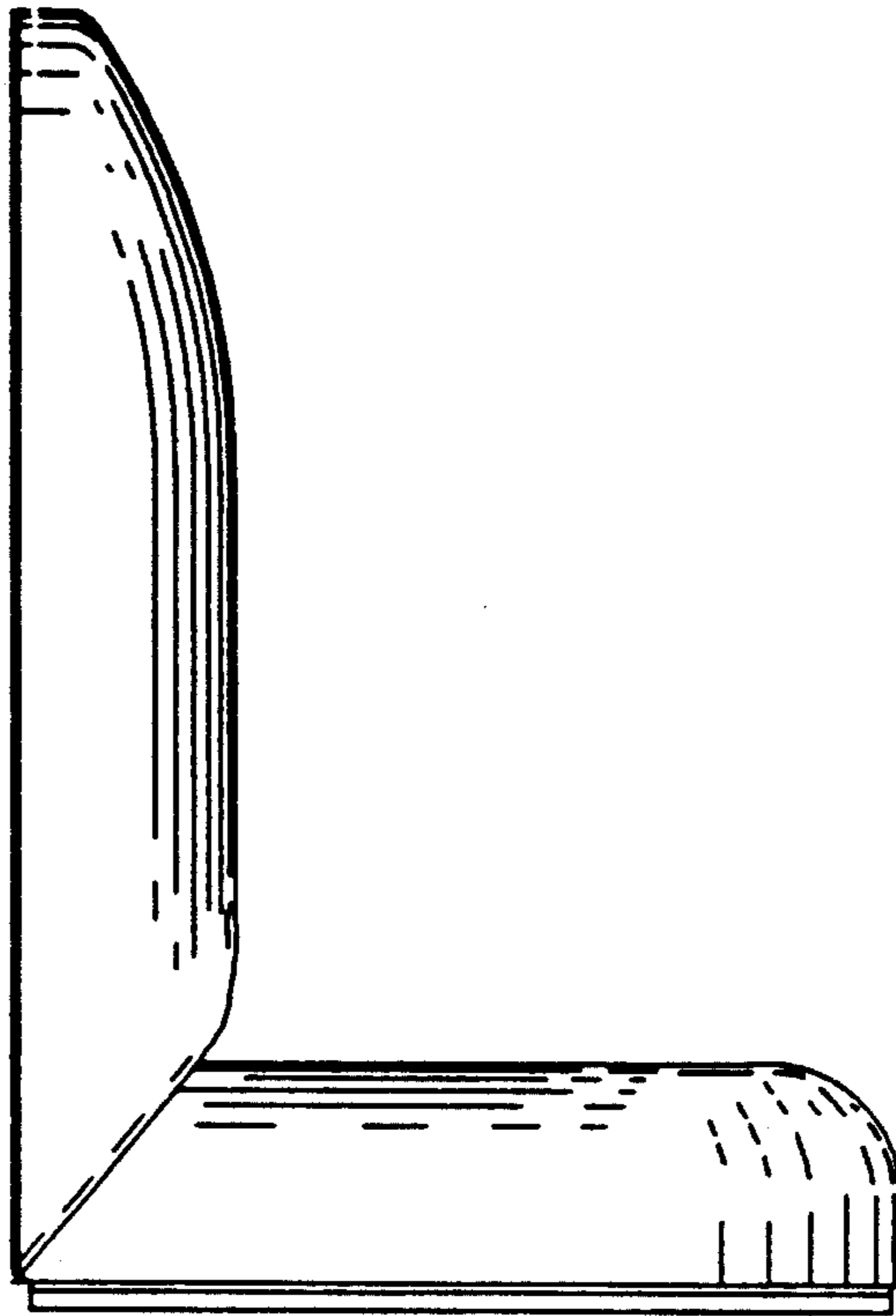

FIG. 4

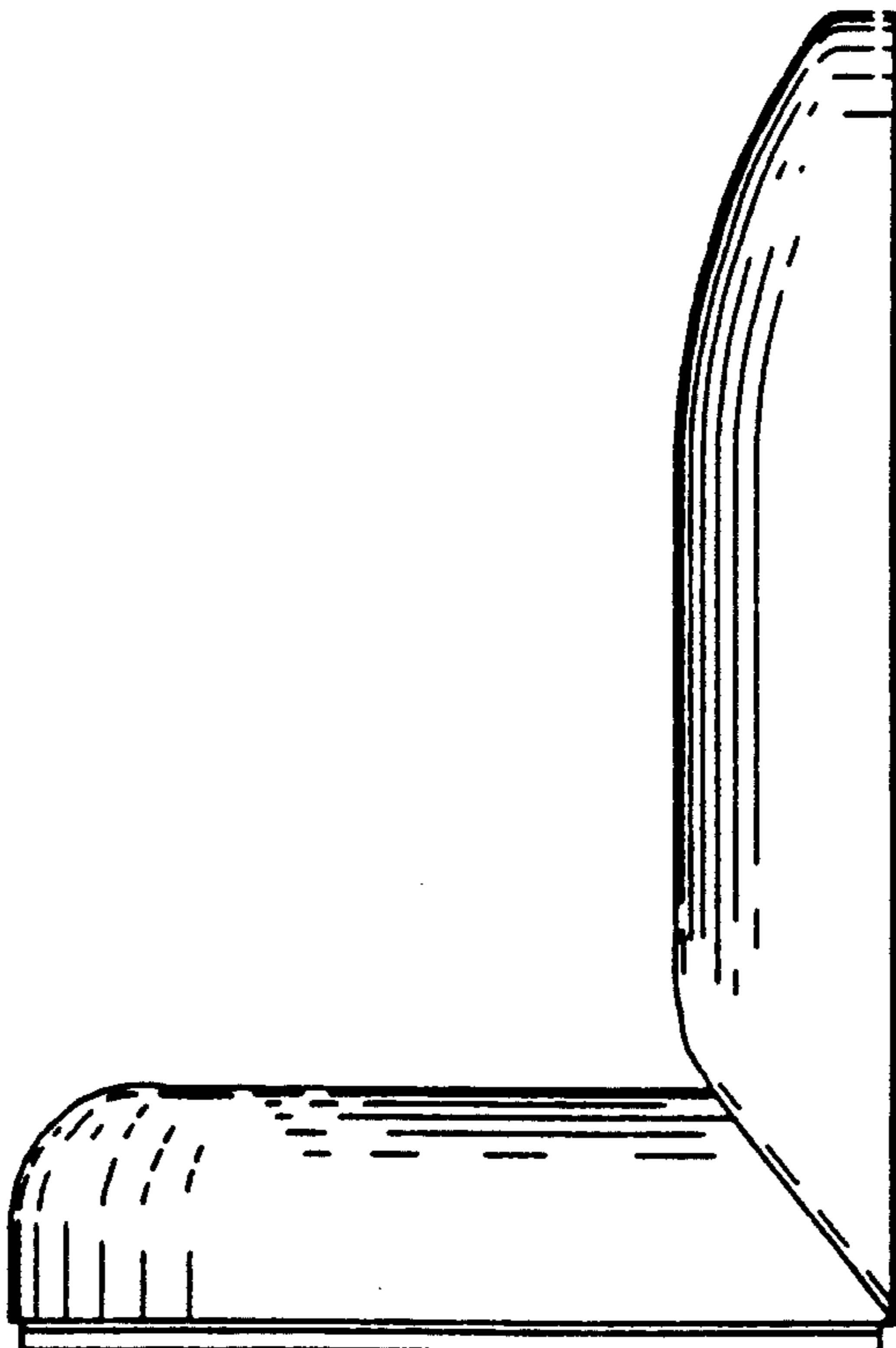

FIG. 5

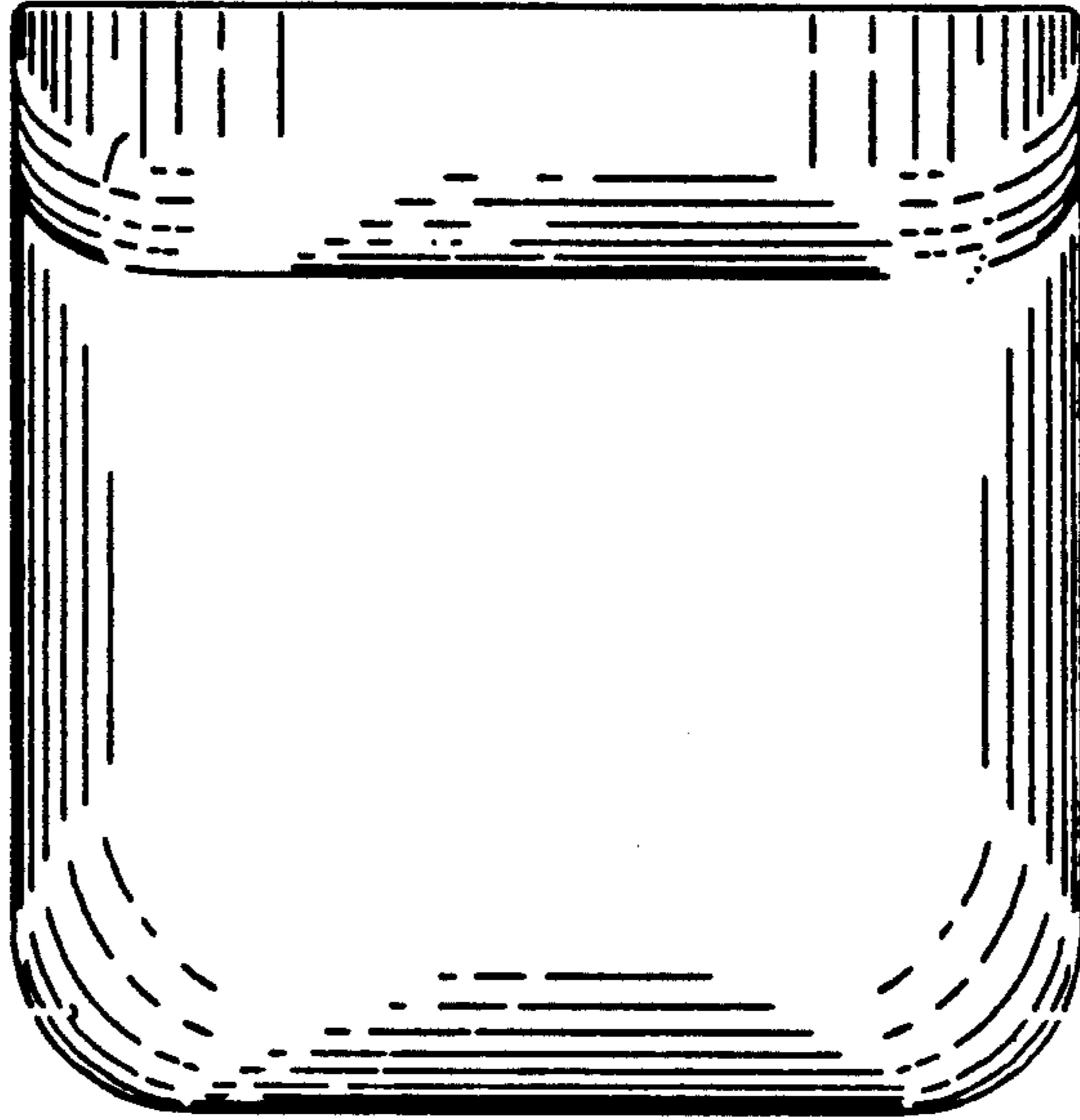

FIG. 6

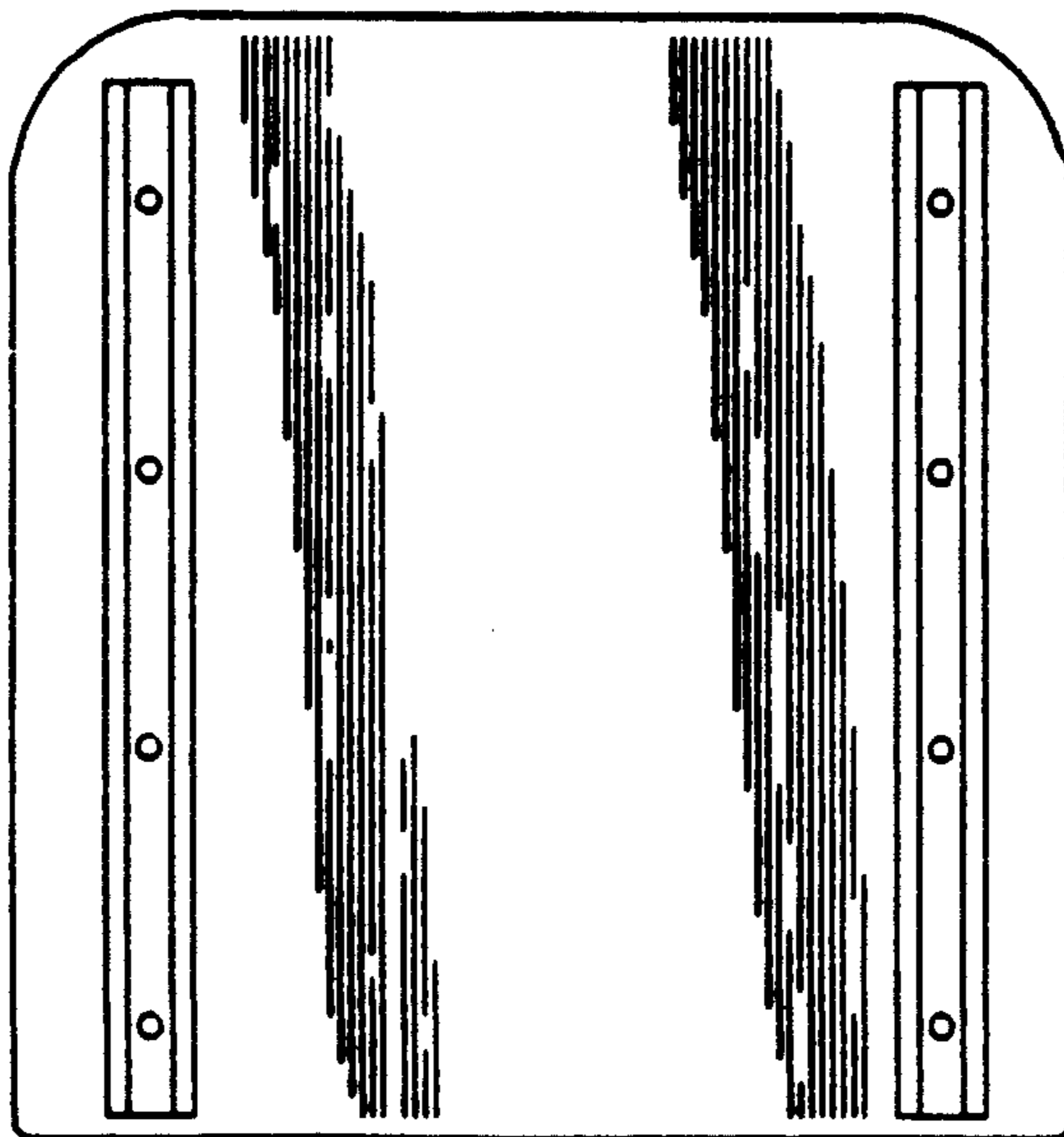

FIG. 7

