



US00D344632S

United States Patent [19]

[11] Patent Number: **Des. 344,632**

Owens

[45] Date of Patent: **** Mar. 1, 1994**

[54] BACK SUPPORTED CARPET CLEANING UNIT

[76] Inventor: **Robert J. Owens**, 11 Chamblet St., Boston, Mass. 02125

[**] Term: **14 Years**

[21] Appl. No.: **730,306**

[22] Filed: **Jul. 15, 1991**

[52] U.S. Cl. **D4/115; D32/45**

[58] Field of Search **D4/114, 115, 127, 129, D4/130; 15/104.92; 401/6, 41-42, 188 R, 270, 282-289; D32/17, 30, 35, 45**

[56] References Cited

U.S. PATENT DOCUMENTS

2,310,006	2/1943	Wisner	401/6
2,504,487	4/1950	Anson	401/285
4,152,084	5/1979	Melton et al.	401/188 R

FOREIGN PATENT DOCUMENTS

1489009 6/1967 France 401/188

Primary Examiner—Susan J. Lucas
Assistant Examiner—Lavone D. Tabor
Attorney, Agent, or Firm—Terry M. Gernstein

[57] CLAIM

The ornamental design for a back supported carpet cleaning unit, as shown and described.

DESCRIPTION

FIG. 1 is a perspective view of the back supported carpet cleaning unit embodying the design of the present invention;

FIG. 2 is a reduced front elevational view thereof;

FIG. 3 is a rear elevational view thereof;

FIG. 4 is a side elevational view thereof;

FIG. 5 is the opposite side elevational view thereof;

FIG. 6 is a top plan view thereof; and,

FIG. 7 is a bottom view thereof.

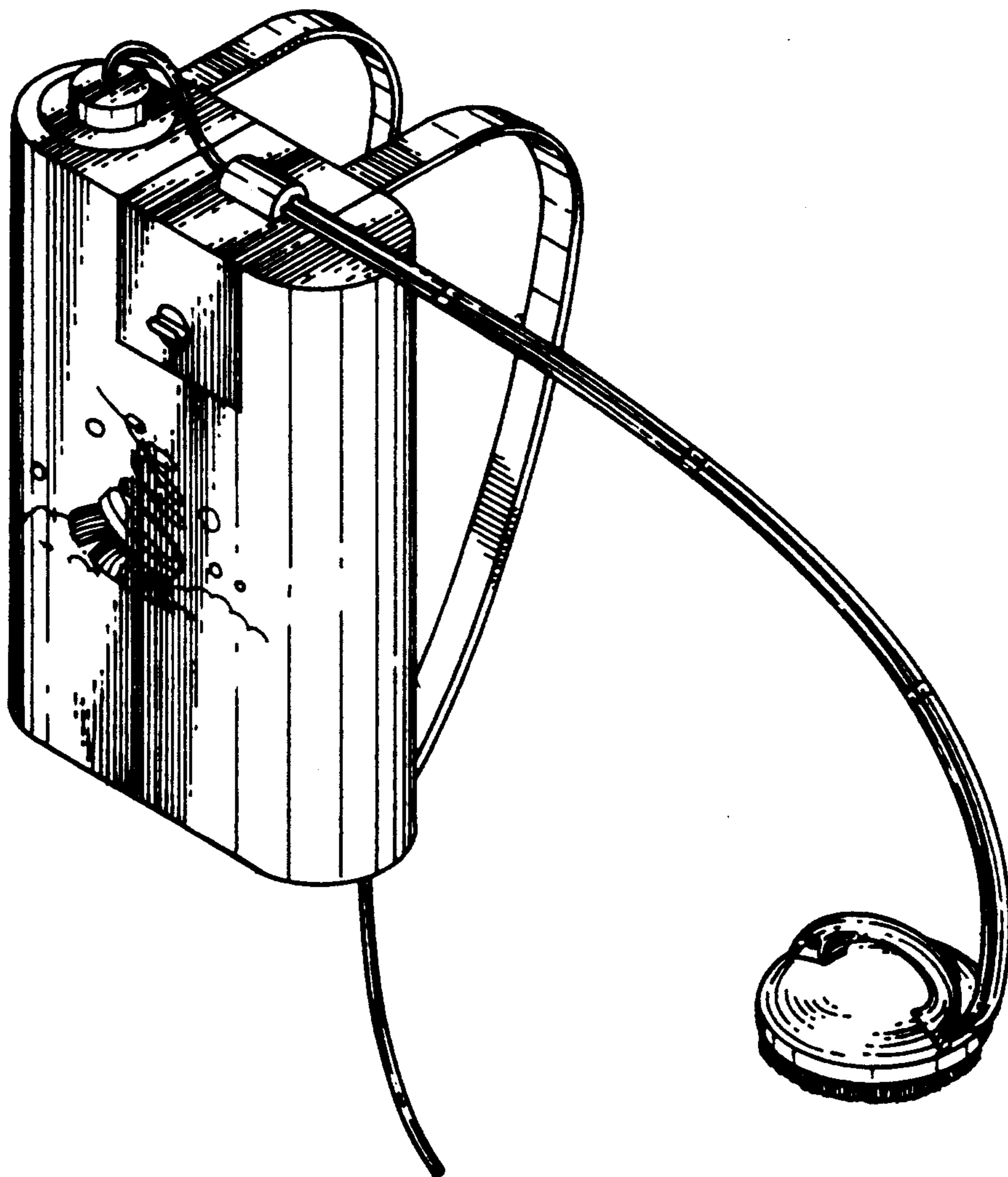

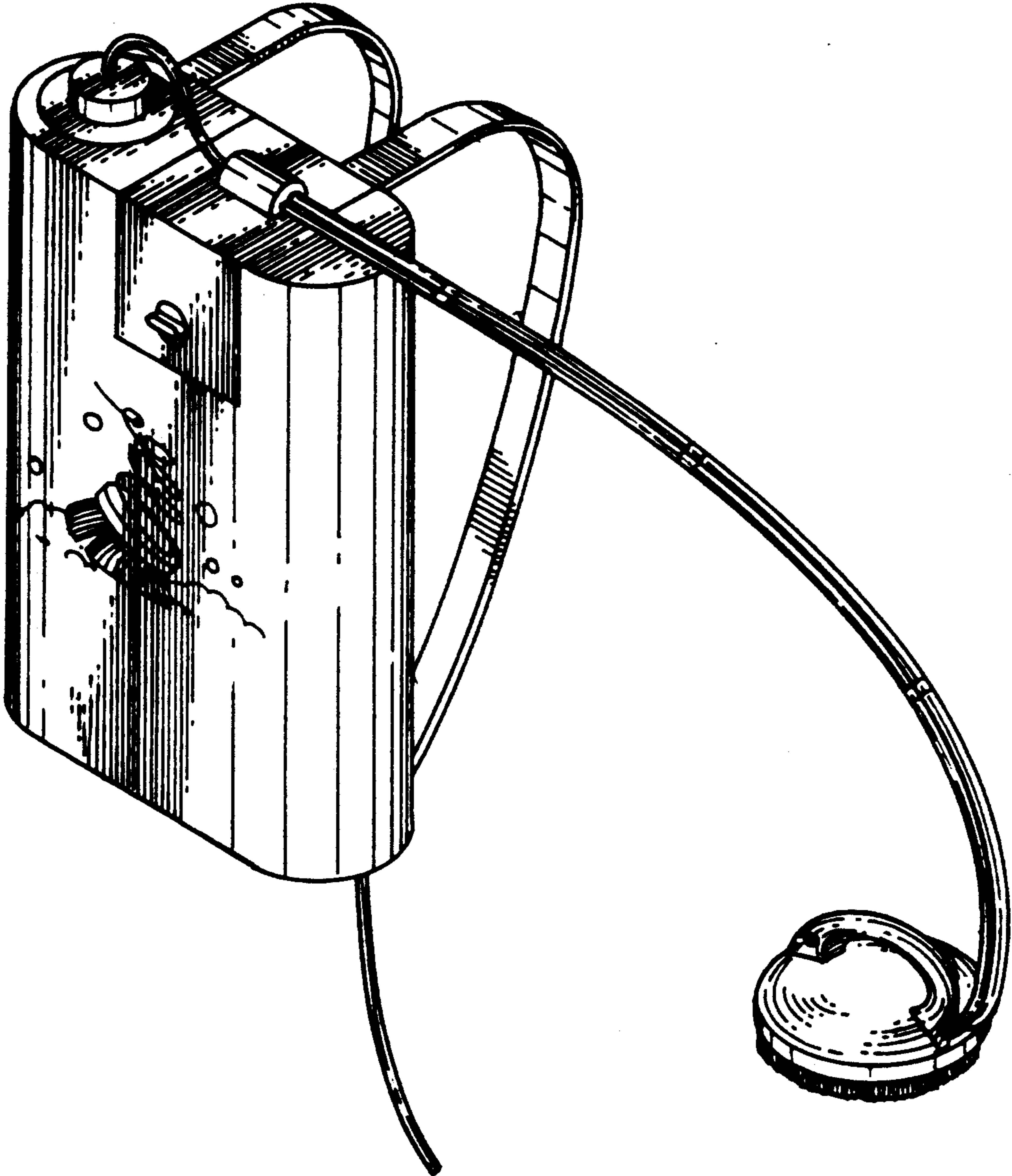

FIG. 1

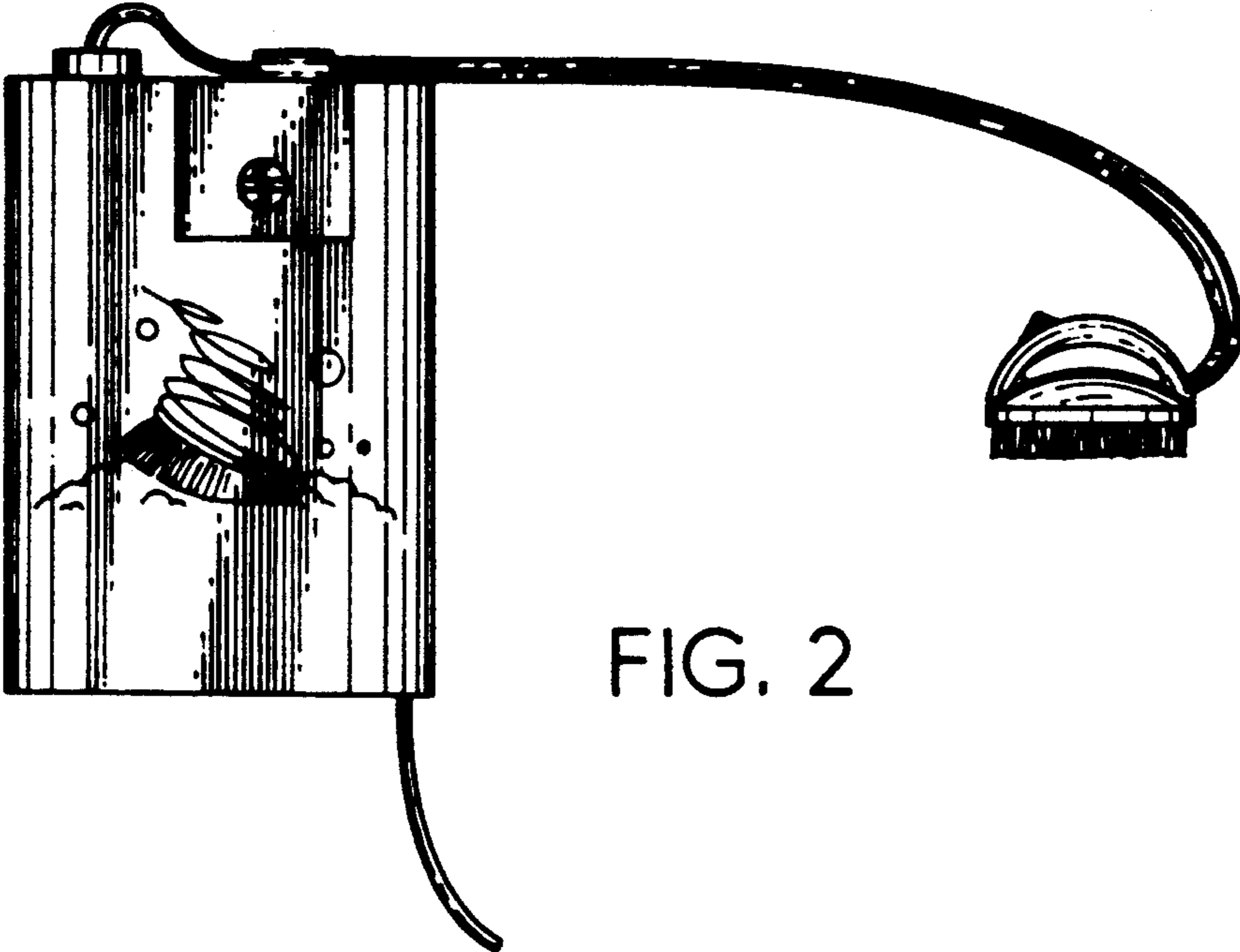

FIG. 2

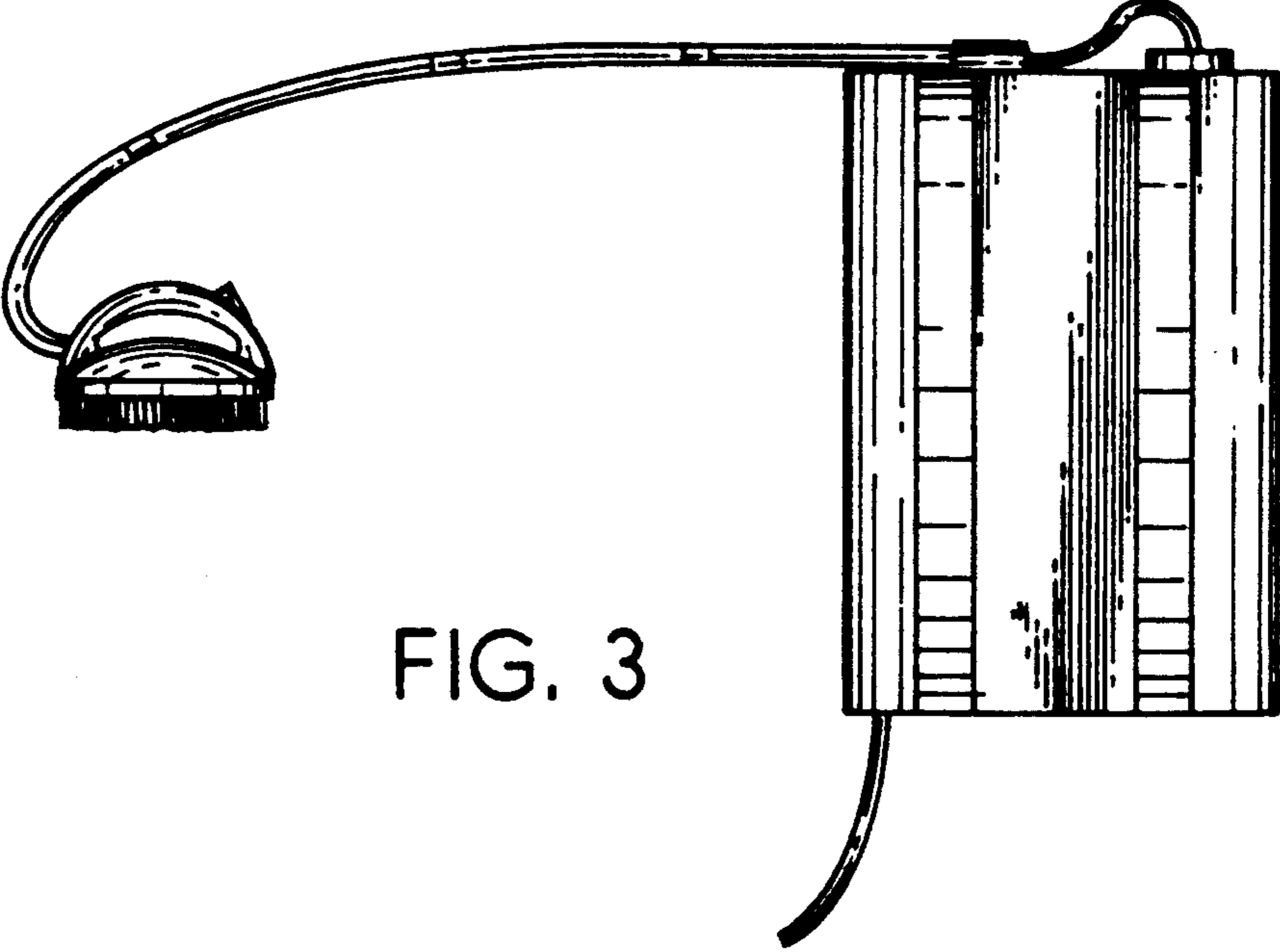

FIG. 3

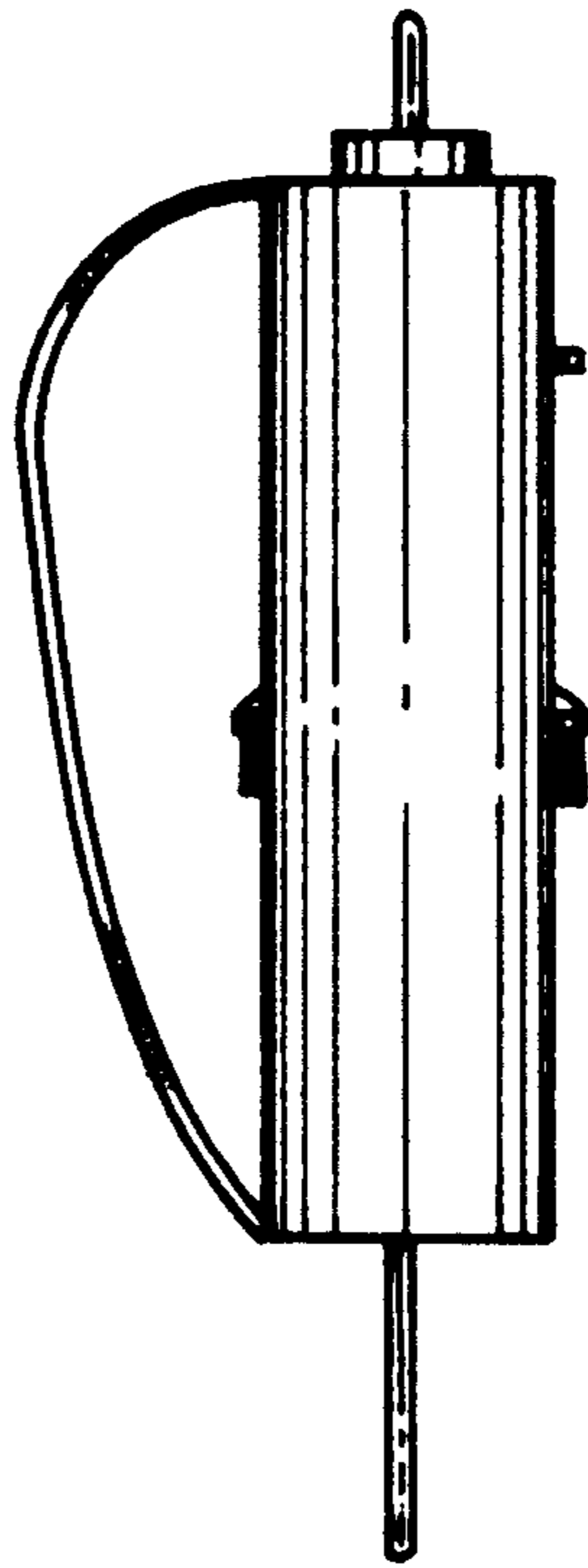

FIG. 4

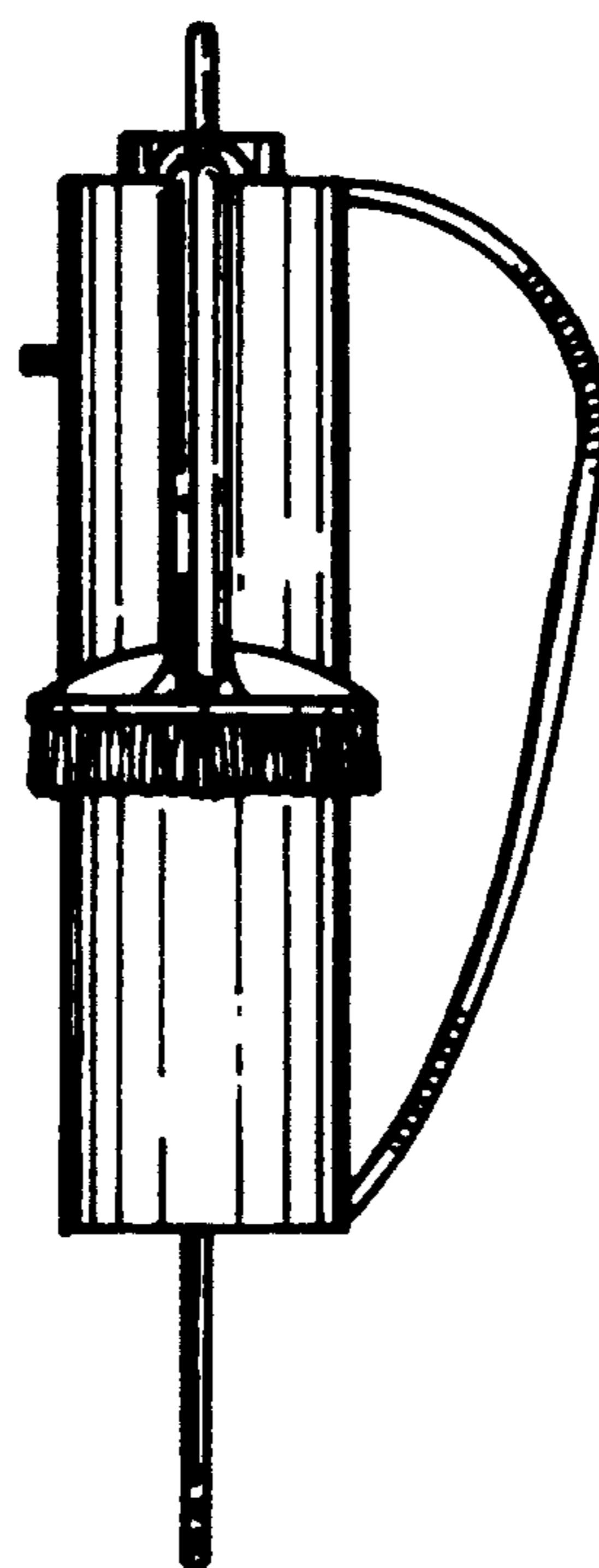

FIG. 5

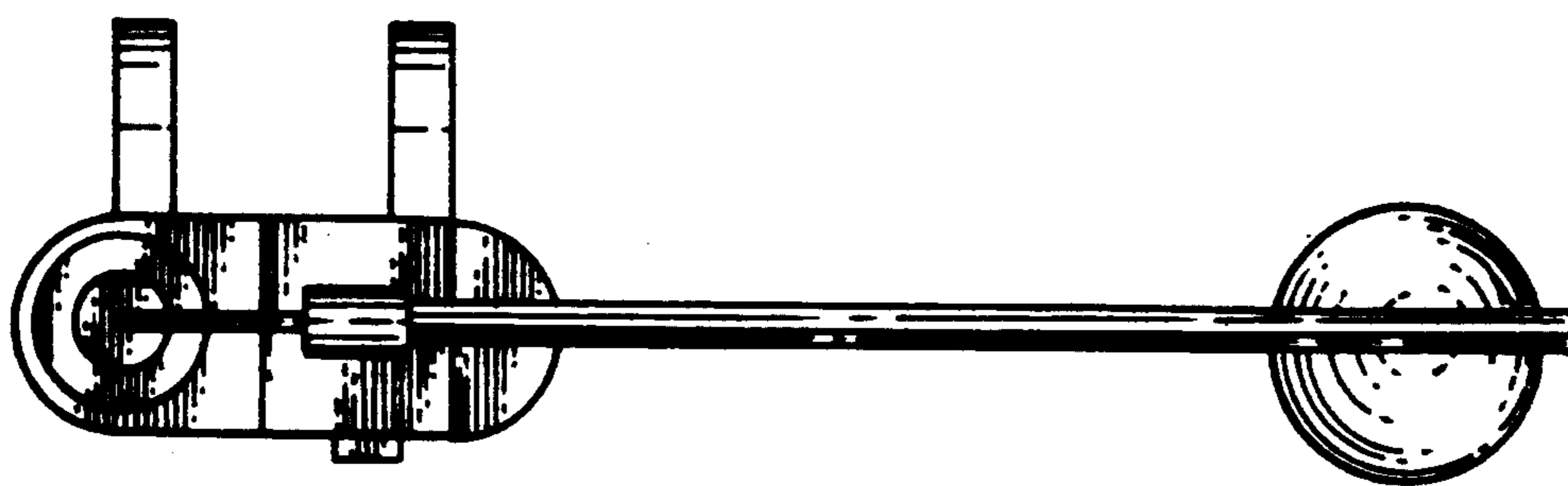

FIG. 6

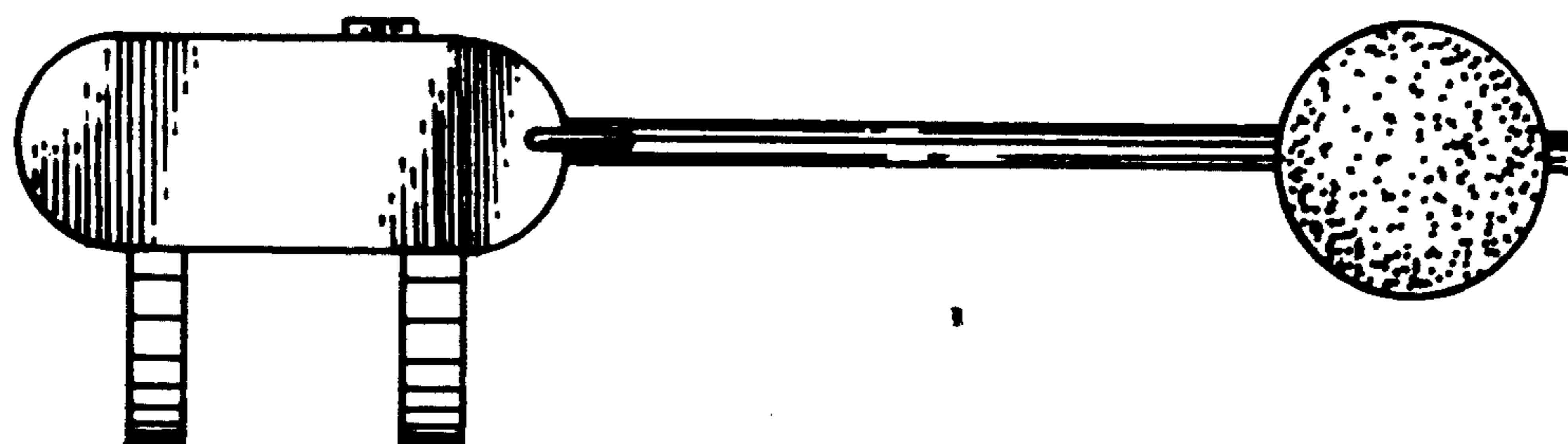

FIG. 7