



US00D344578S

United States Patent [19]

[11] Patent Number: **Des. 344,578**

Ohaus et al.

[45] Date of Patent: **** Feb. 22, 1994**

[54] LAVATORY

[75] Inventors: **Karl G. Ohaus, Chatham; Jeannette M. Long, Lawrenceville, both of N.J.; Jeff P. Walz, Toronto, Canada**

[73] Assignee: **American Standard Inc., New York, N.Y.**

[**] Term: **14 Years**

[21] Appl. No.: **692,027**

[22] Filed: **Apr. 26, 1991**

[52] U.S. Cl. **D23/294**

[58] Field of Search **4/619, 630-640, 4/651; D23/270-274, 284-294, 308**

[56] References Cited

U.S. PATENT DOCUMENTS

D. 240,825	8/1976	Gruber	D23/294
D. 319,689	9/1991	Levin	D23/294
3,358,296	12/1967	Bosler	4/619
3,577,572	5/1971	Ruggles et al.	4/631
4,937,899	7/1990	Morris et al.	4/651

OTHER PUBLICATIONS

Eljer Plumbingware Division Catalog, p. 20, "Burke Lavatory", item.

P. 2-1 from American Standard catalog of Oct. 1977.

Primary Examiner—James R. Largen

Attorney, Agent, or Firm—Elaine Brenner Robinson; Ann M. Knab

[57] CLAIM

The ornamental design for a lavatory, as shown and described.

DESCRIPTION

FIG. 1 is a top, front and left side perspective view of a lavatory showing our new design;

FIG. 2 is a top plan view thereof;

FIG. 3 is a front elevational view thereof;

FIGS. 4 is a right side elevational view thereof;

FIG. 5 is a left side elevational view thereof;

FIG. 6 is a rear elevational view thereof;

FIG. 7 is a bottom plan view thereof; and,

FIG. 8 is a cross-sectional view taken along line 8-8 of FIG. 1.

The broken line representation of openings for fittings in FIGS. 1, 2 and 7 are for purposes of illustration only and form no part of the claimed design.

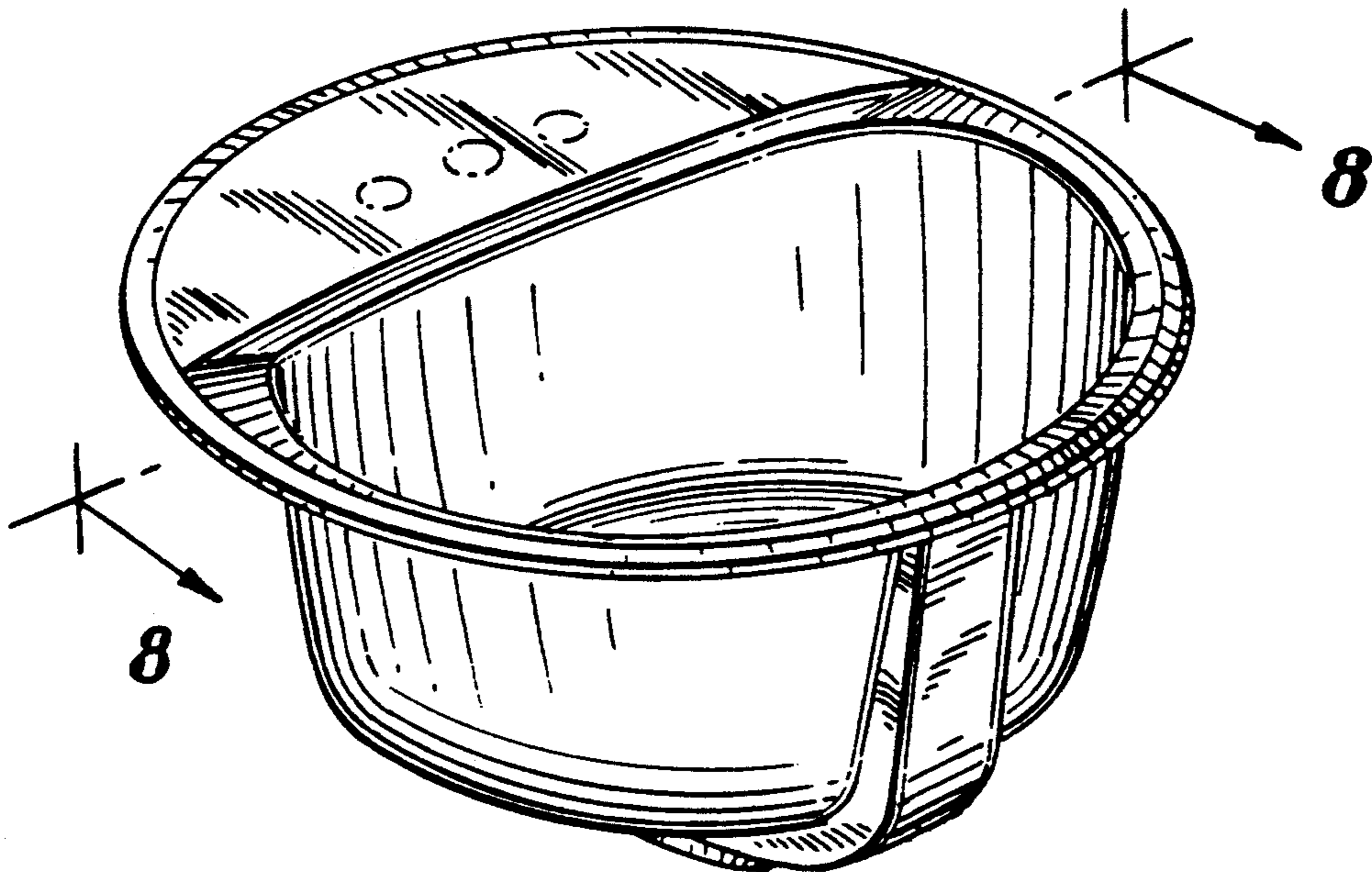

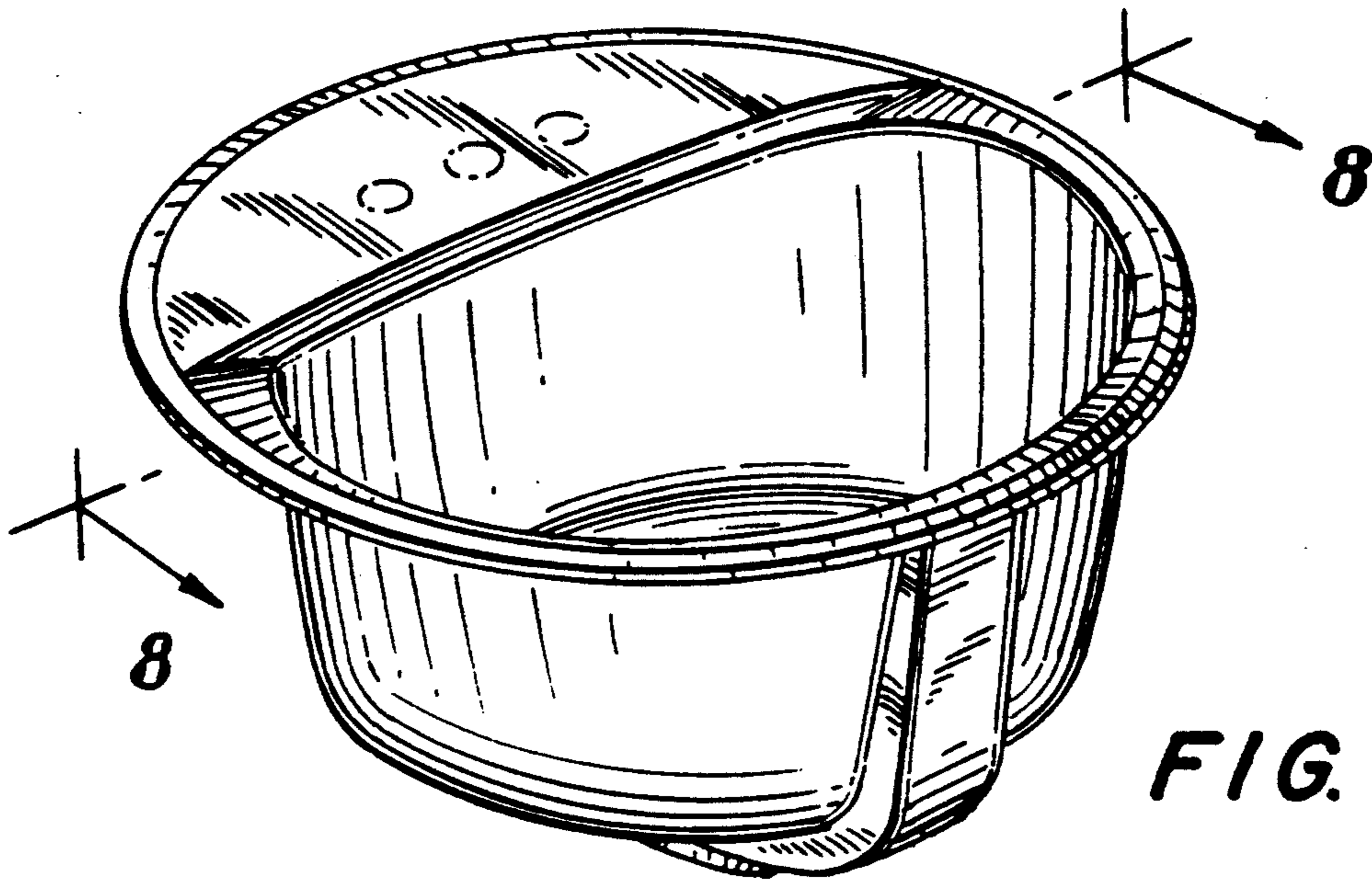

FIG. 1

FIG. 8

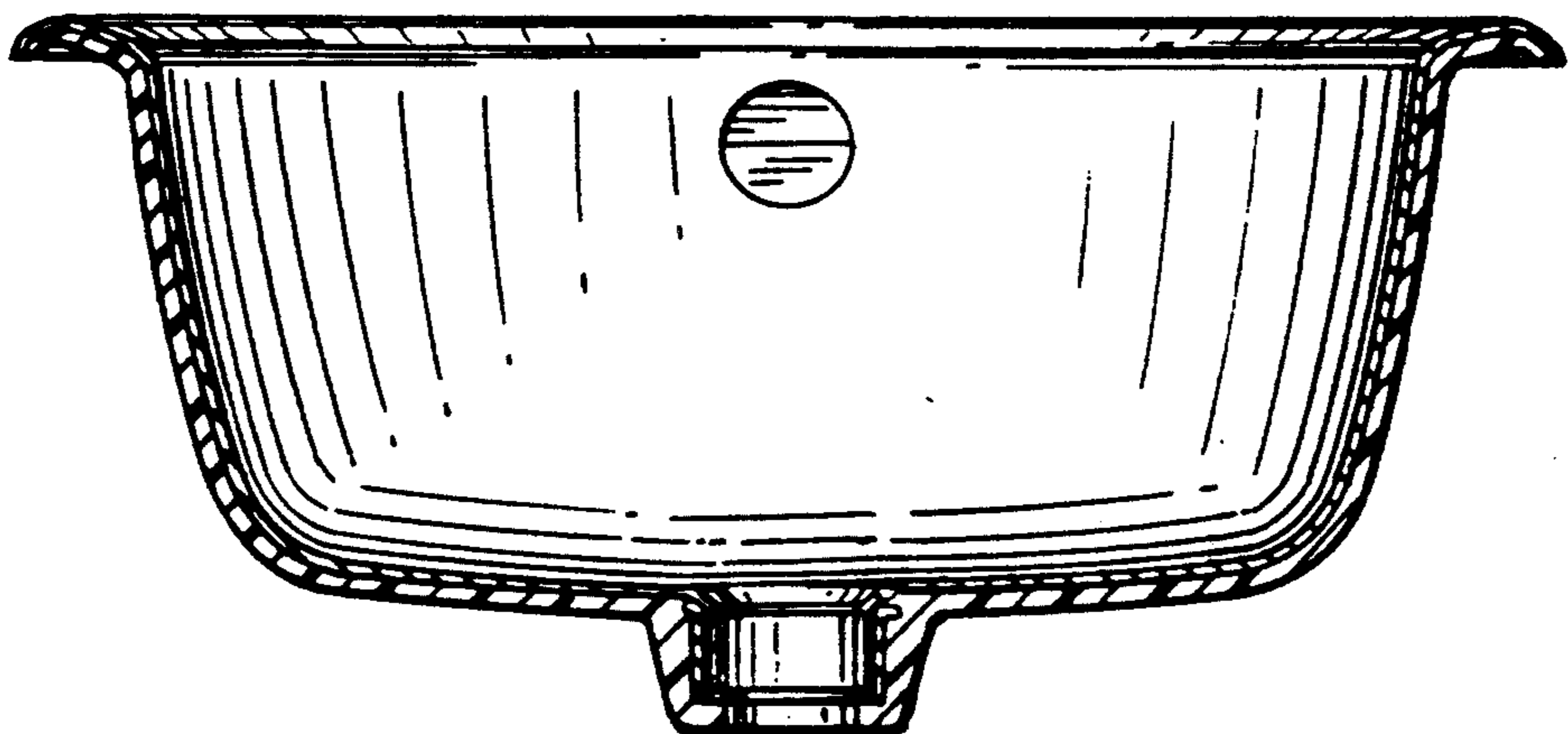

FIG. 2

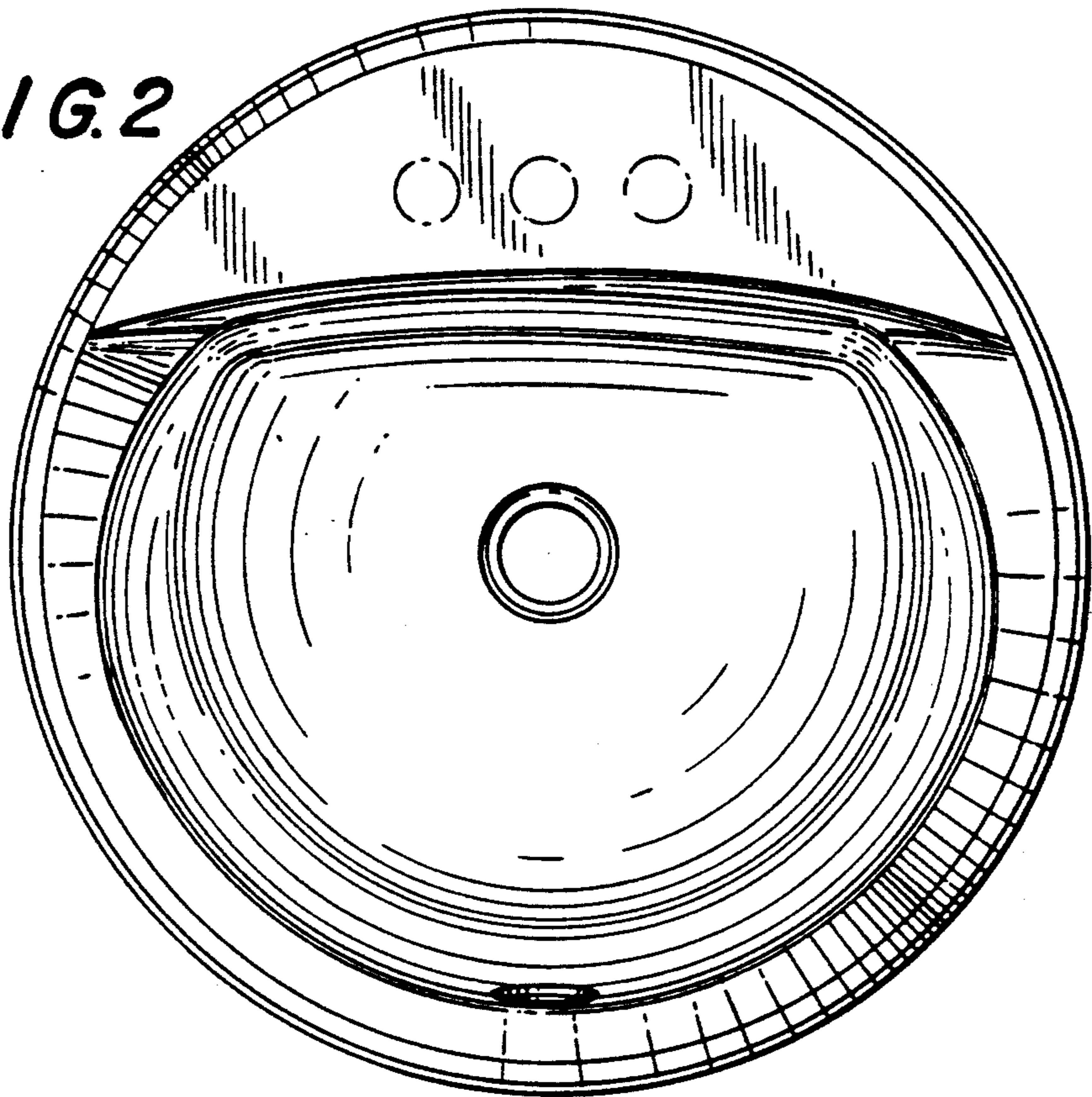

FIG. 3

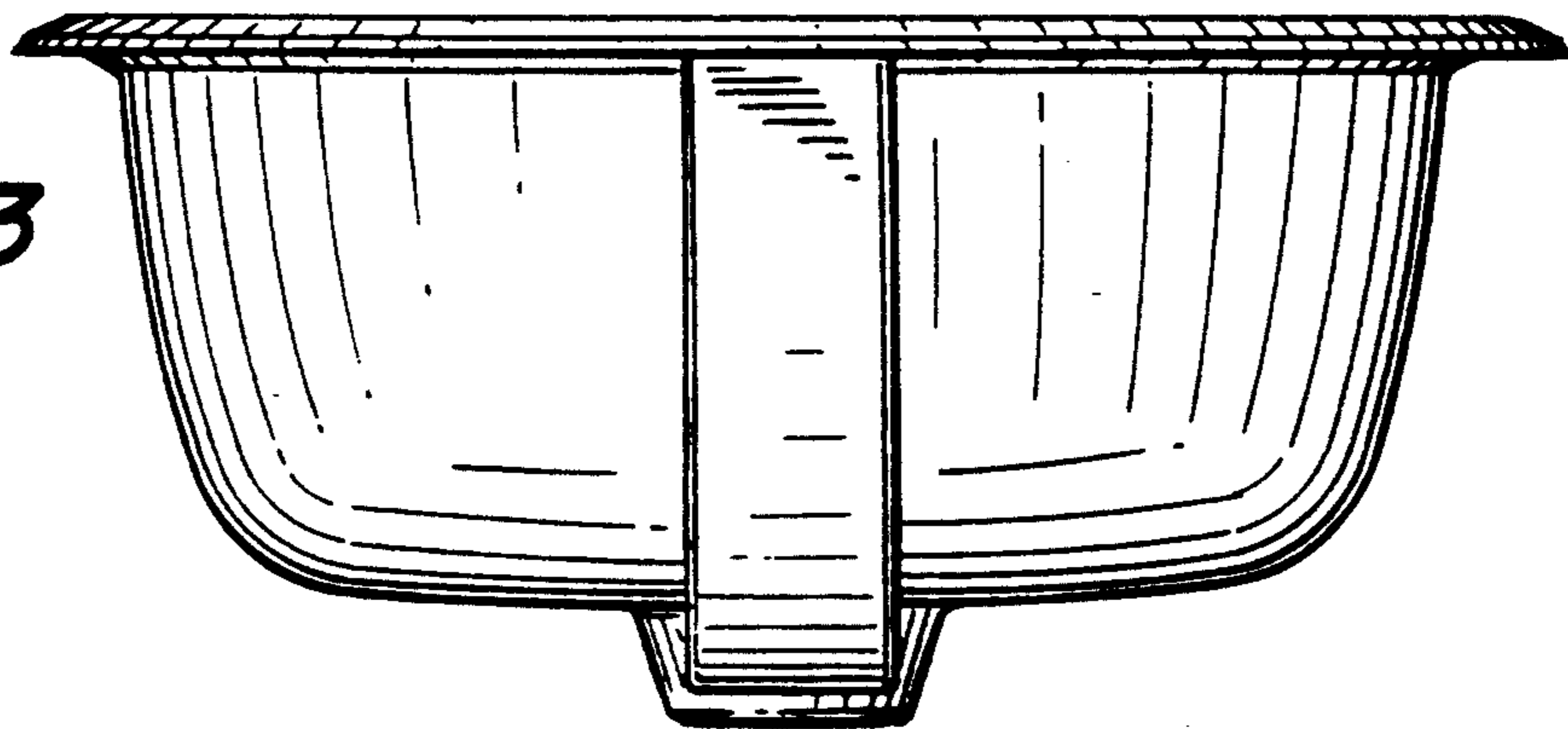
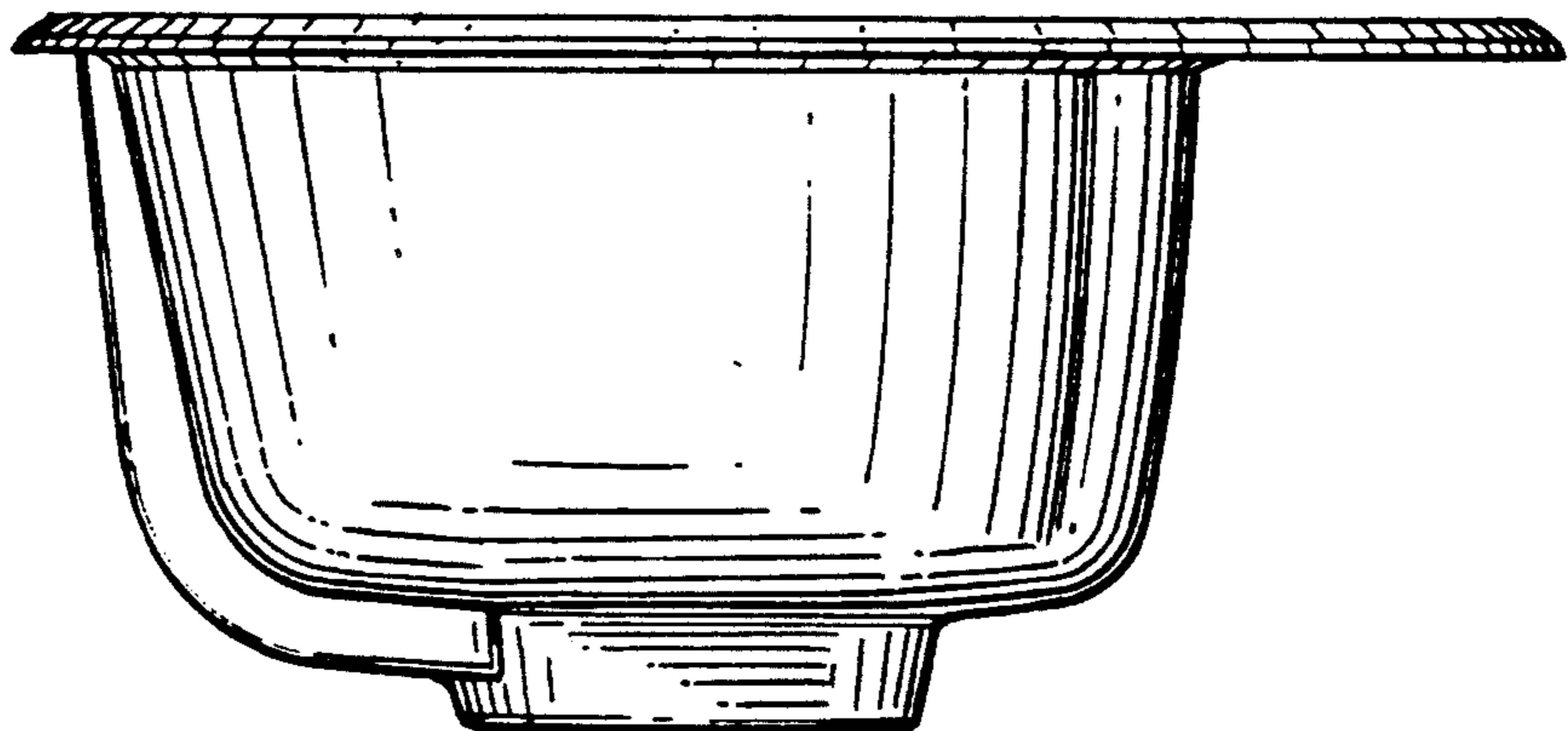

FIG. 4



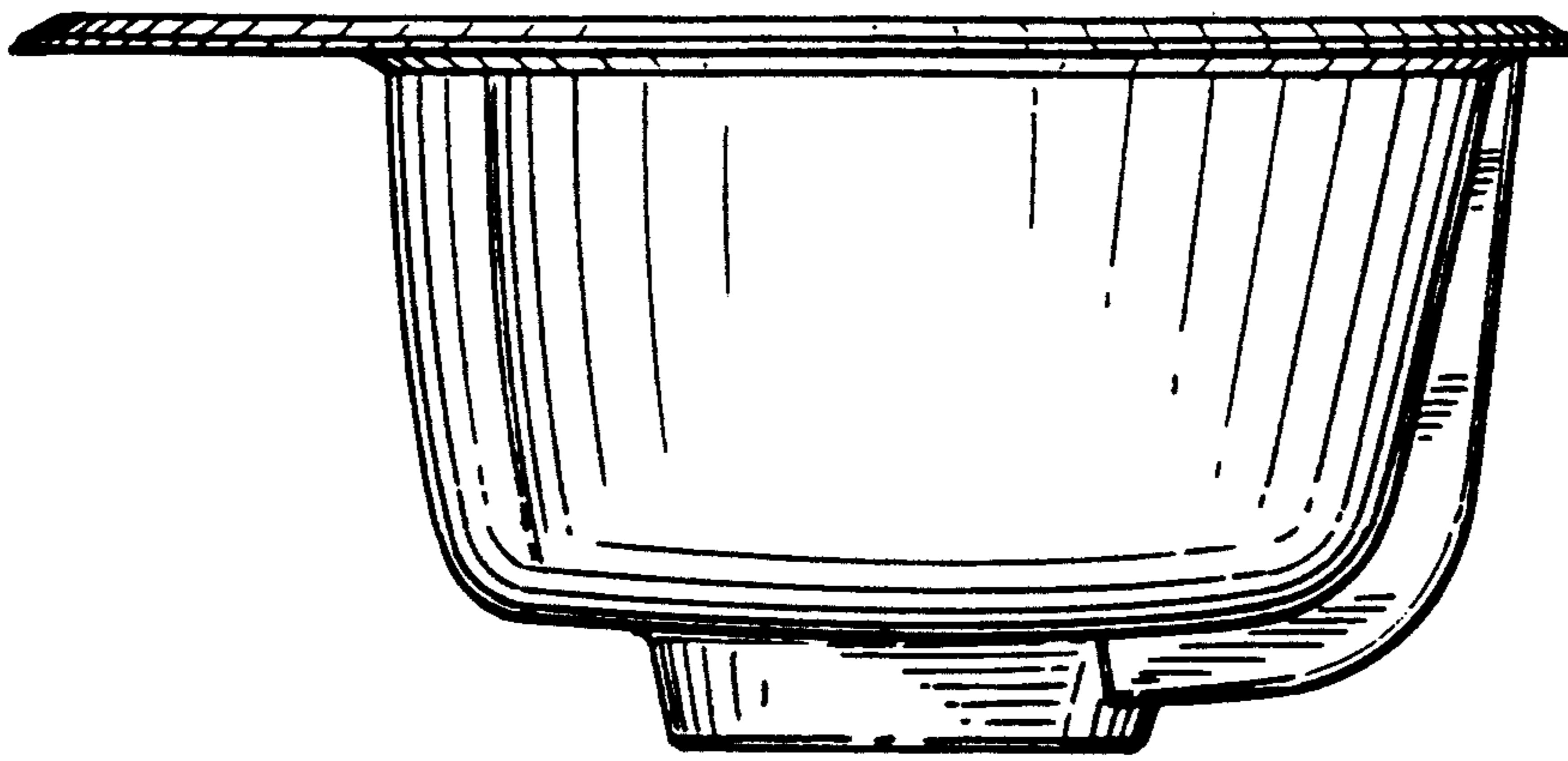

FIG. 5

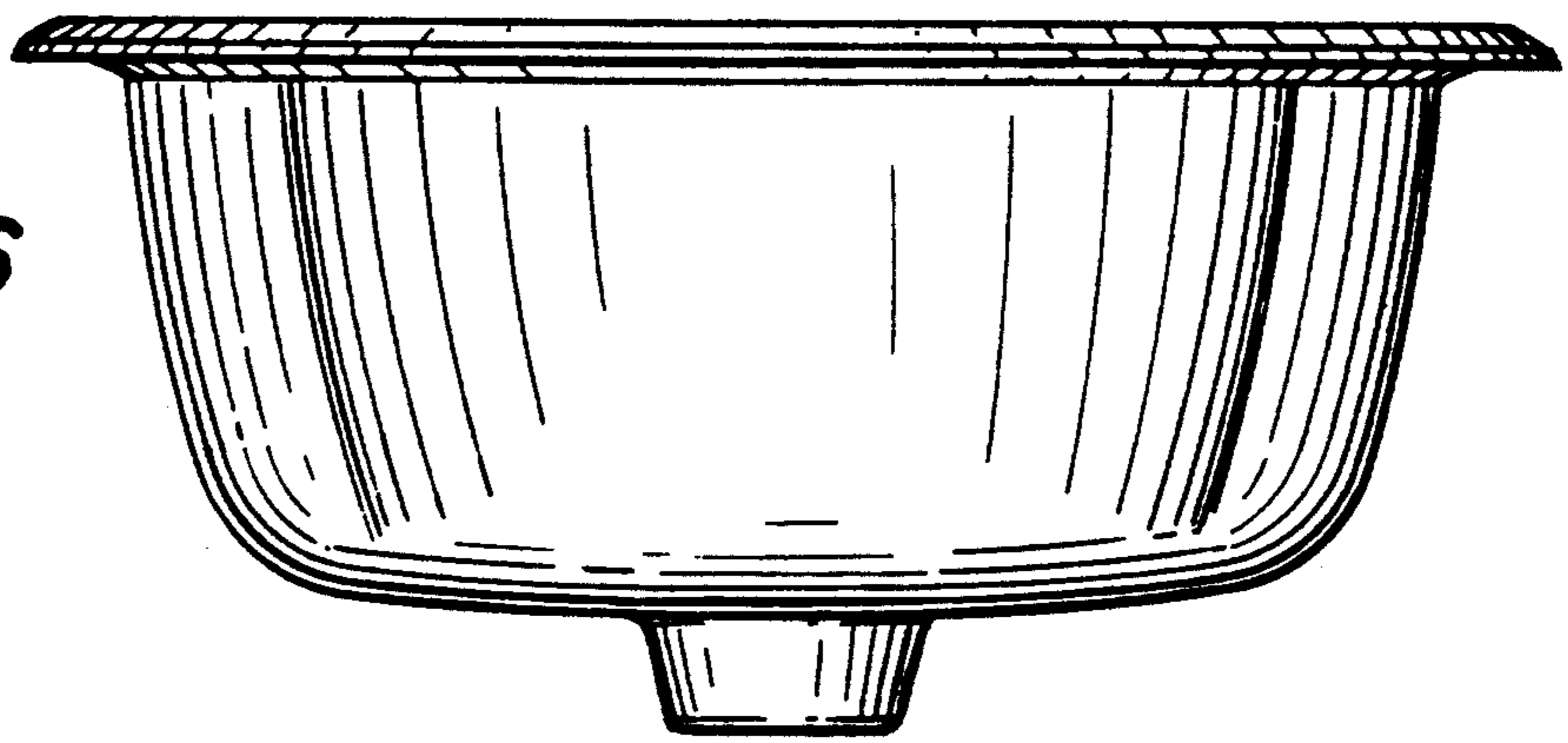

FIG. 6

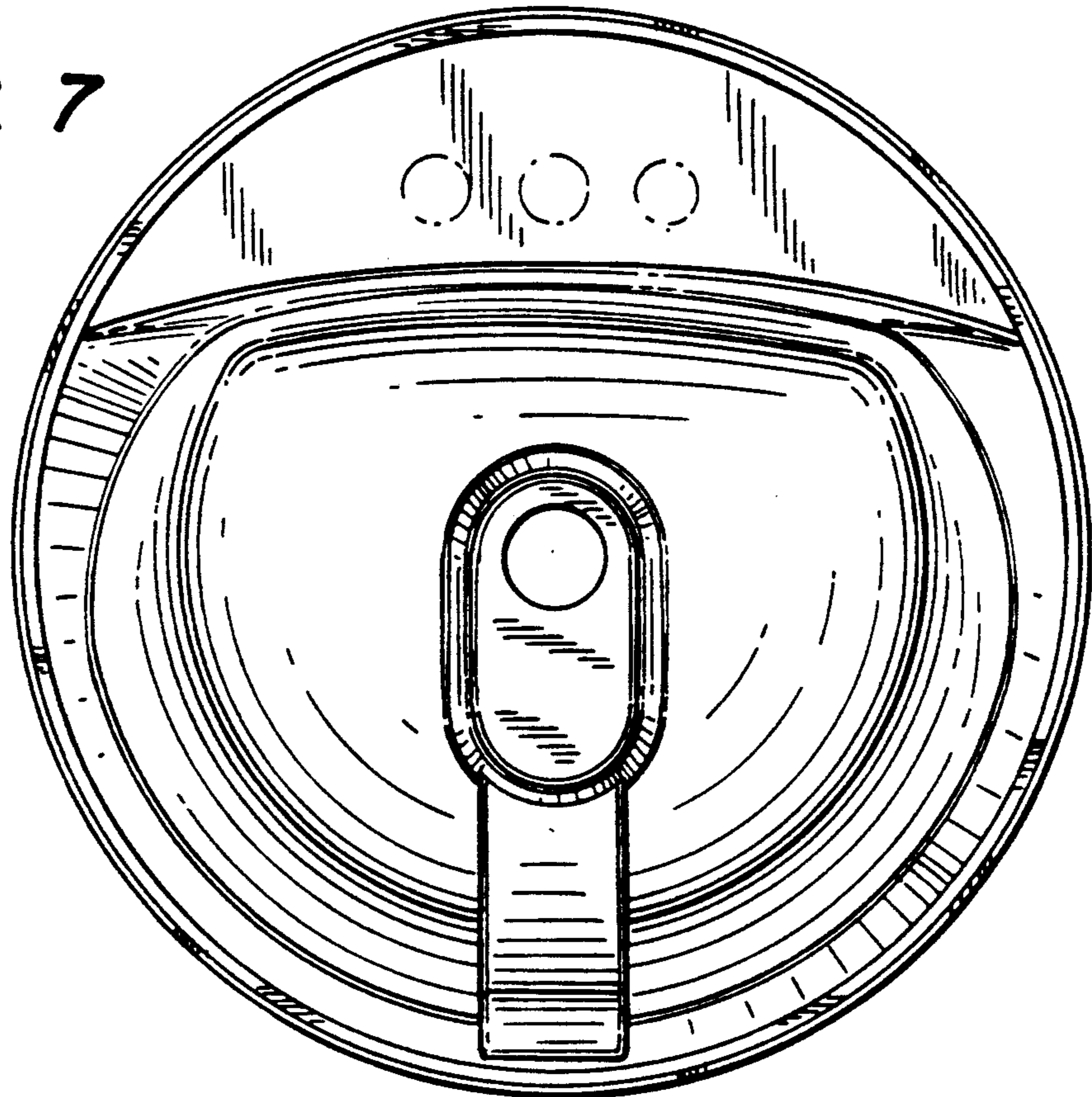

FIG. 7