



US00D344573S

# United States Patent [19]

Bruno et al.

[11] Patent Number: **Des. 344,573**

[45] Date of Patent: **\*\* Feb. 22, 1994**

[54] **PERSONAL SHOWER HEAD**

[75] Inventors: **Robert H. Bruno, Avon; Tim C. Repp, New Hartford, both of Conn.**

[73] Assignee: **Pollenex Corporation, Chicago, Ill.**

[\*\*] Term: **14 Years**

[21] Appl. No.: **900,249**

[22] Filed: **Jan. 17, 1992**

[52] U.S. Cl. .... **D23/223**

[58] Field of Search ..... **4/567-570, 4/599-603, 596, 615, 675-678; 239/276, 280-281, 282-283, 288.5, 310, 443-449, 456-460, 525, 550-552, 556-559, 562-565, 567, 581.1, 586-588; D23/213, 223-229**

[56] **References Cited**

**U.S. PATENT DOCUMENTS**

- D. 241,546 9/1976 Rizzuto ..... D23/223
- D. 245,859 9/1977 Grube ..... D23/223
- D. 295,437 4/1988 Fabian ..... D23/223
- D. 317,348 6/1991 Geneve et al. .... D23/223

- D. 327,729 7/1992 Rogers ..... D23/223
- D. 328,634 8/1992 Ward ..... D23/223
- 5,070,552 12/1991 Gentry et al. .... 4/615

*Primary Examiner*—Wallace R. Burke  
*Assistant Examiner*—M. H. Tung  
*Attorney, Agent, or Firm*—Laff, Whitesel, Conte & Saret

[57] **CLAIM**

The ornamental design for a personal shower head, as shown.

**DESCRIPTION**

FIG. 1 is a top plan view of the personal shower head; FIG. 2 is a left side elevation of the personal shower head; FIG. 3 is a right side elevation of the personal shower head; FIG. 4 is a front elevation of the personal shower head; FIG. 5 is a bottom plan view of the personal shower head; FIG. 6 is a back elevation of the personal shower head; and, FIG. 7 is a three-quarter perspective view taken from the front right of the personal shower head.

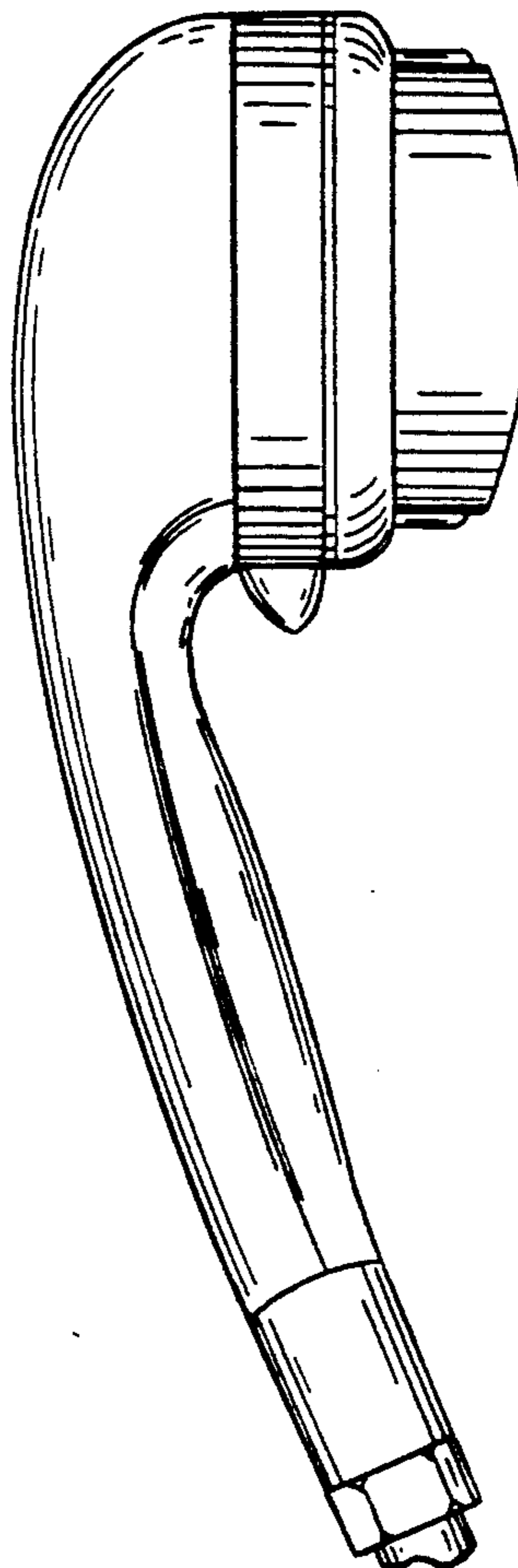
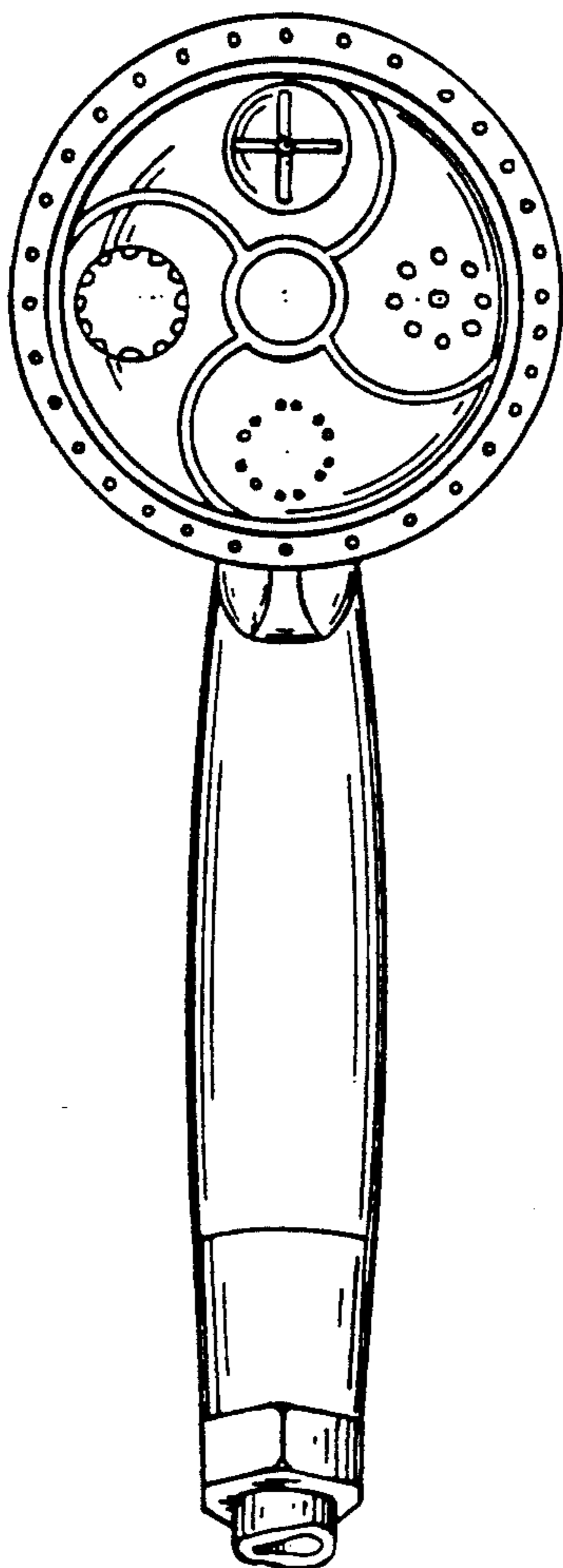

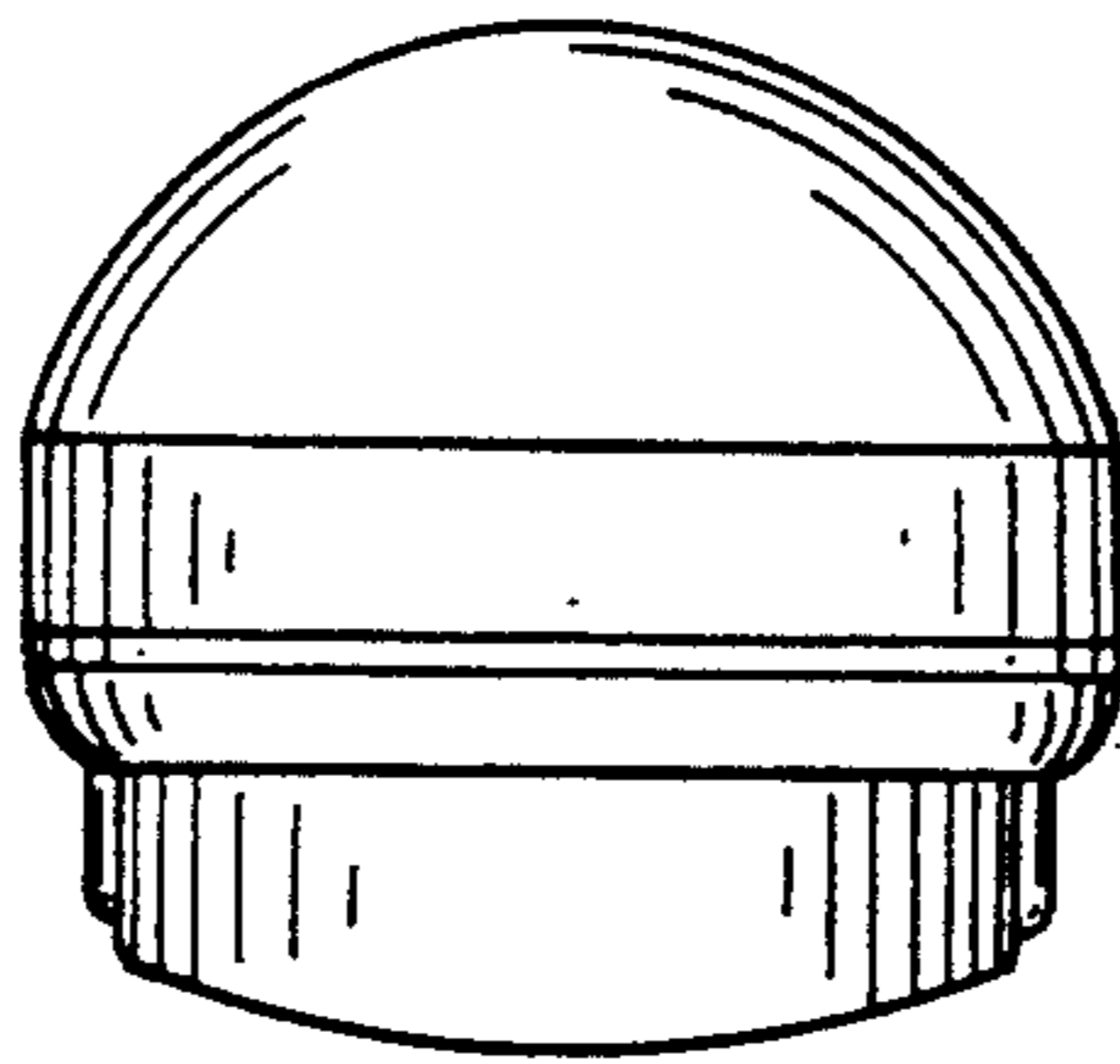

FIG. 4

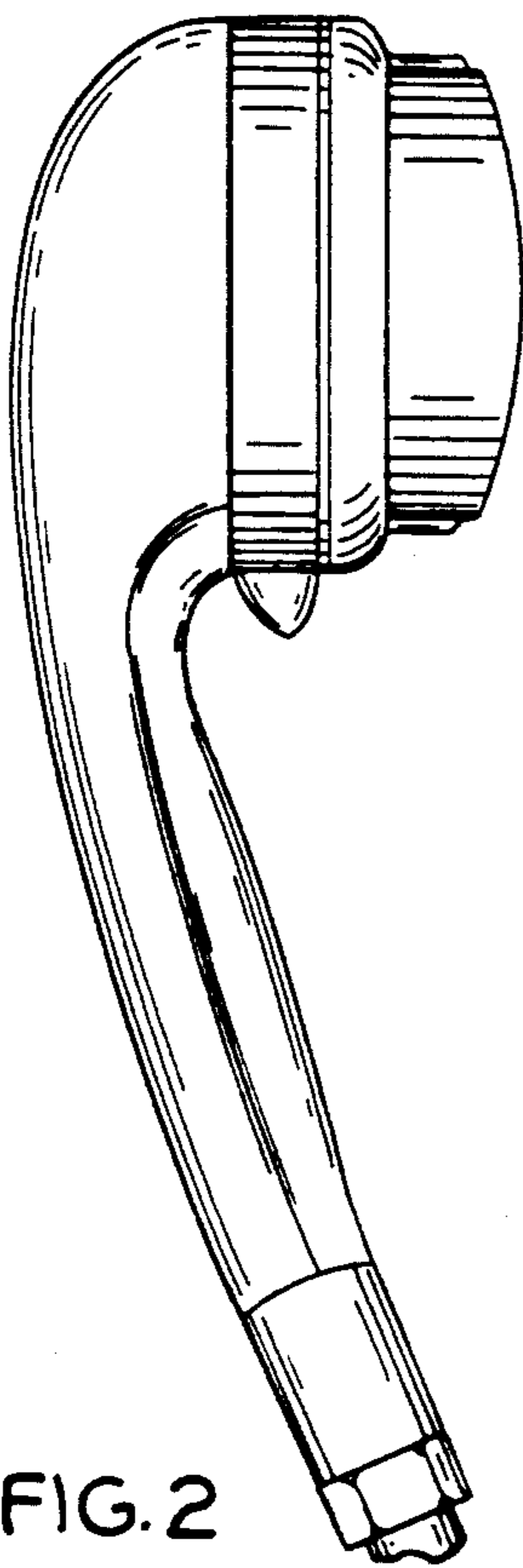

FIG. 2

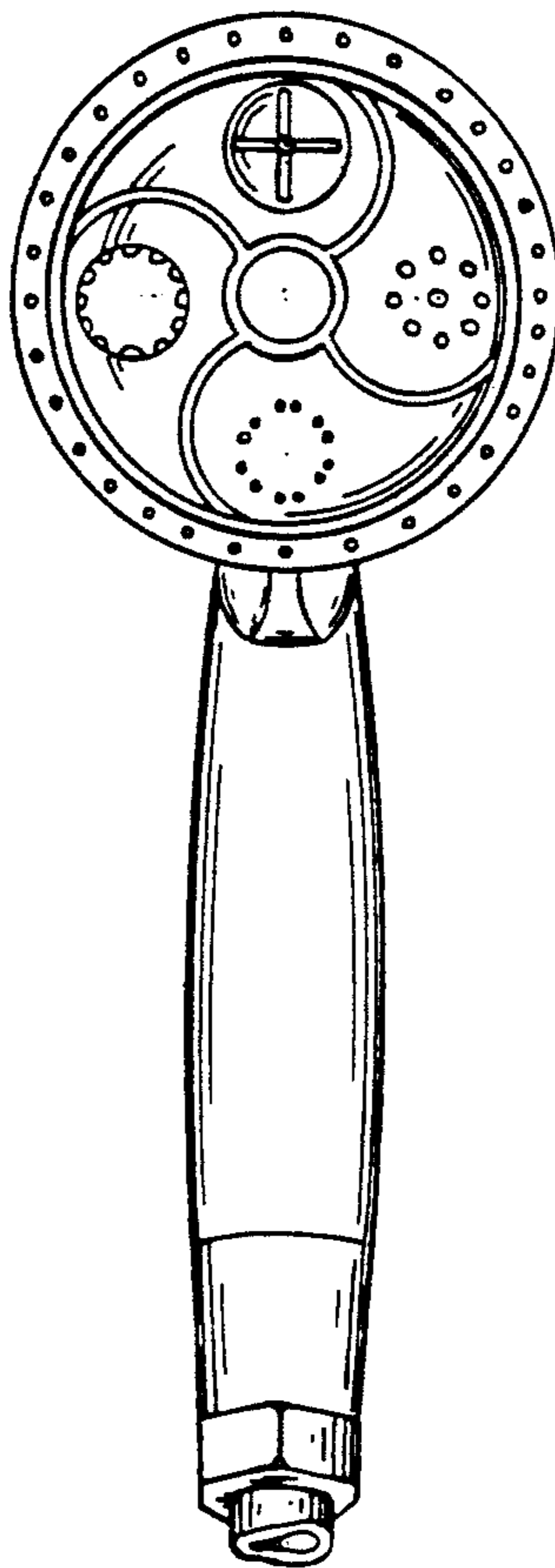

FIG. 1

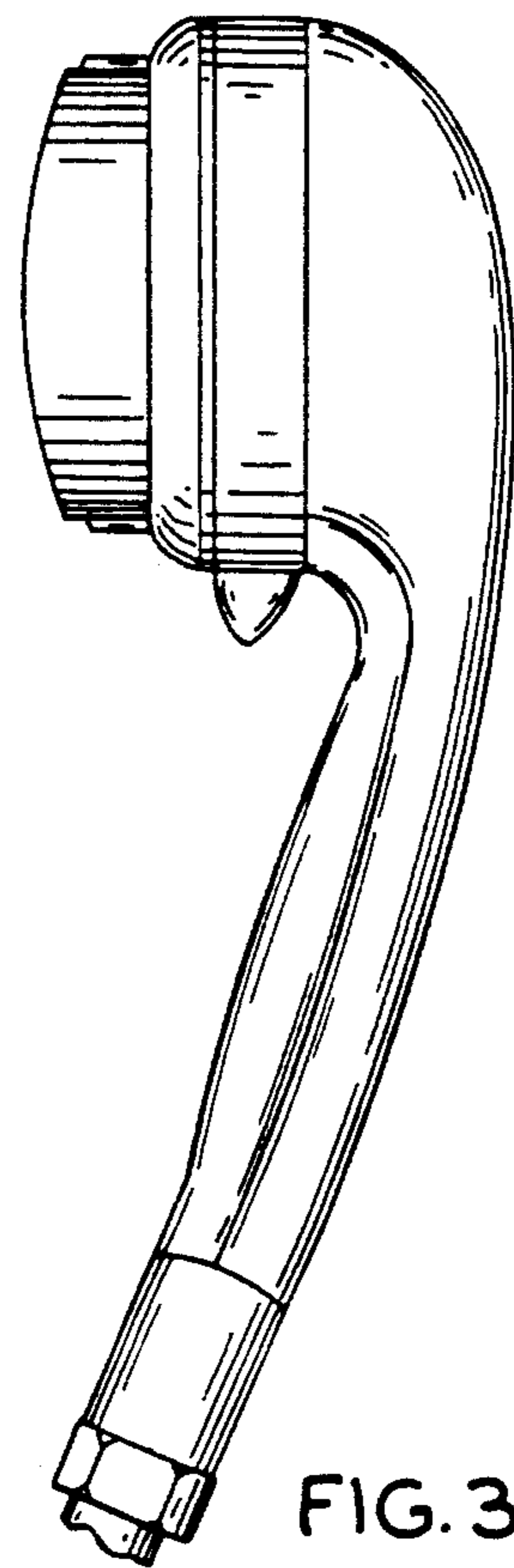

FIG. 3

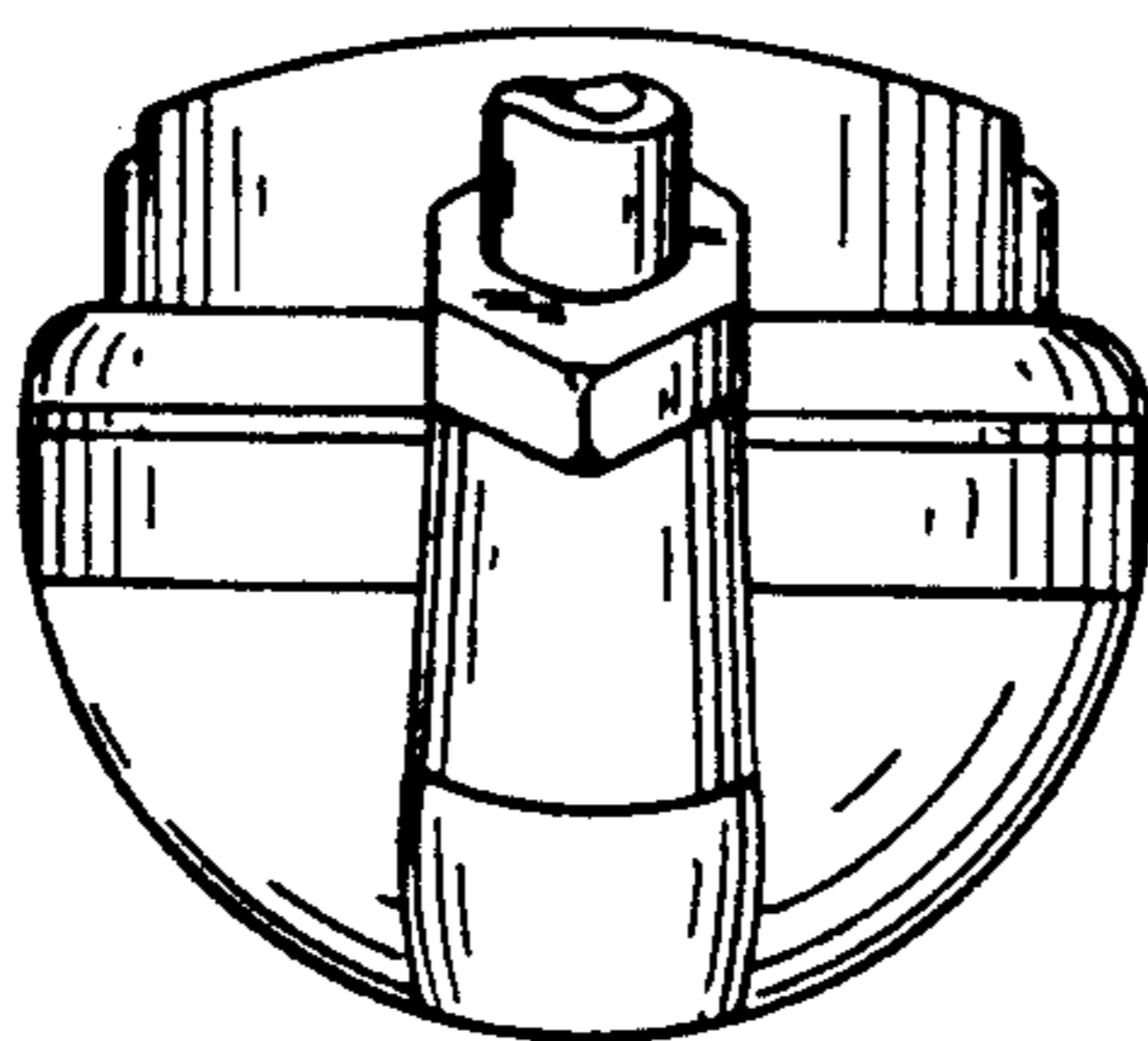

FIG. 5

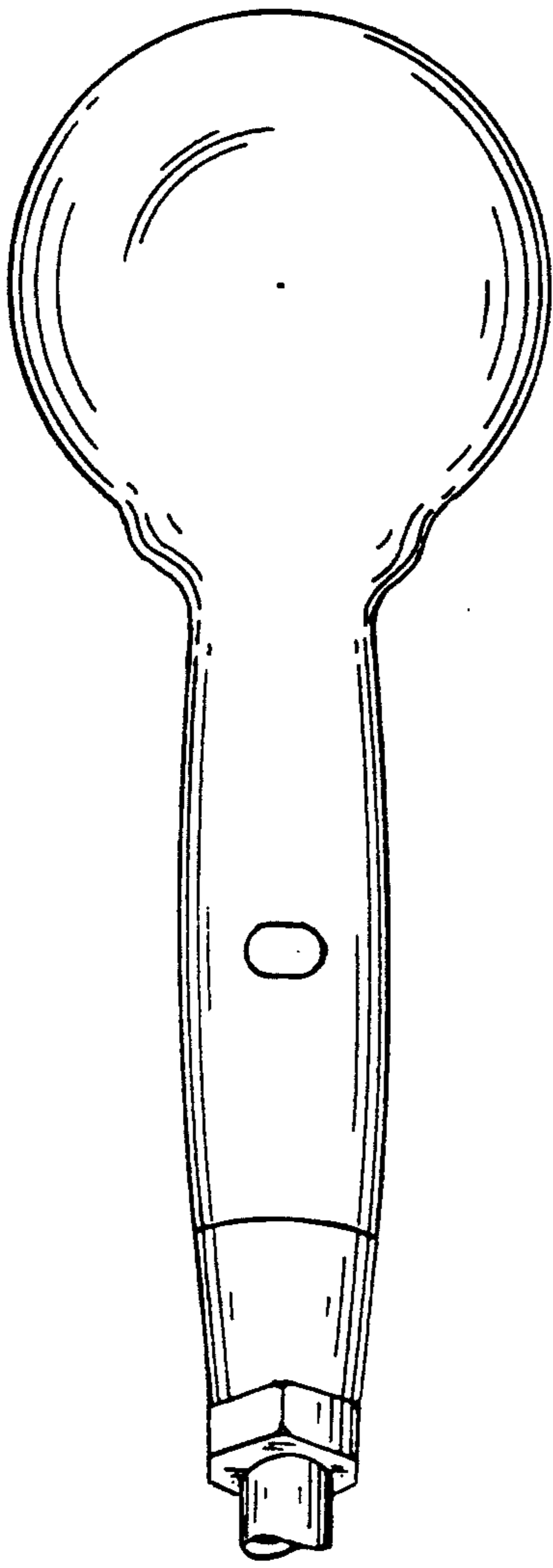

FIG. 6

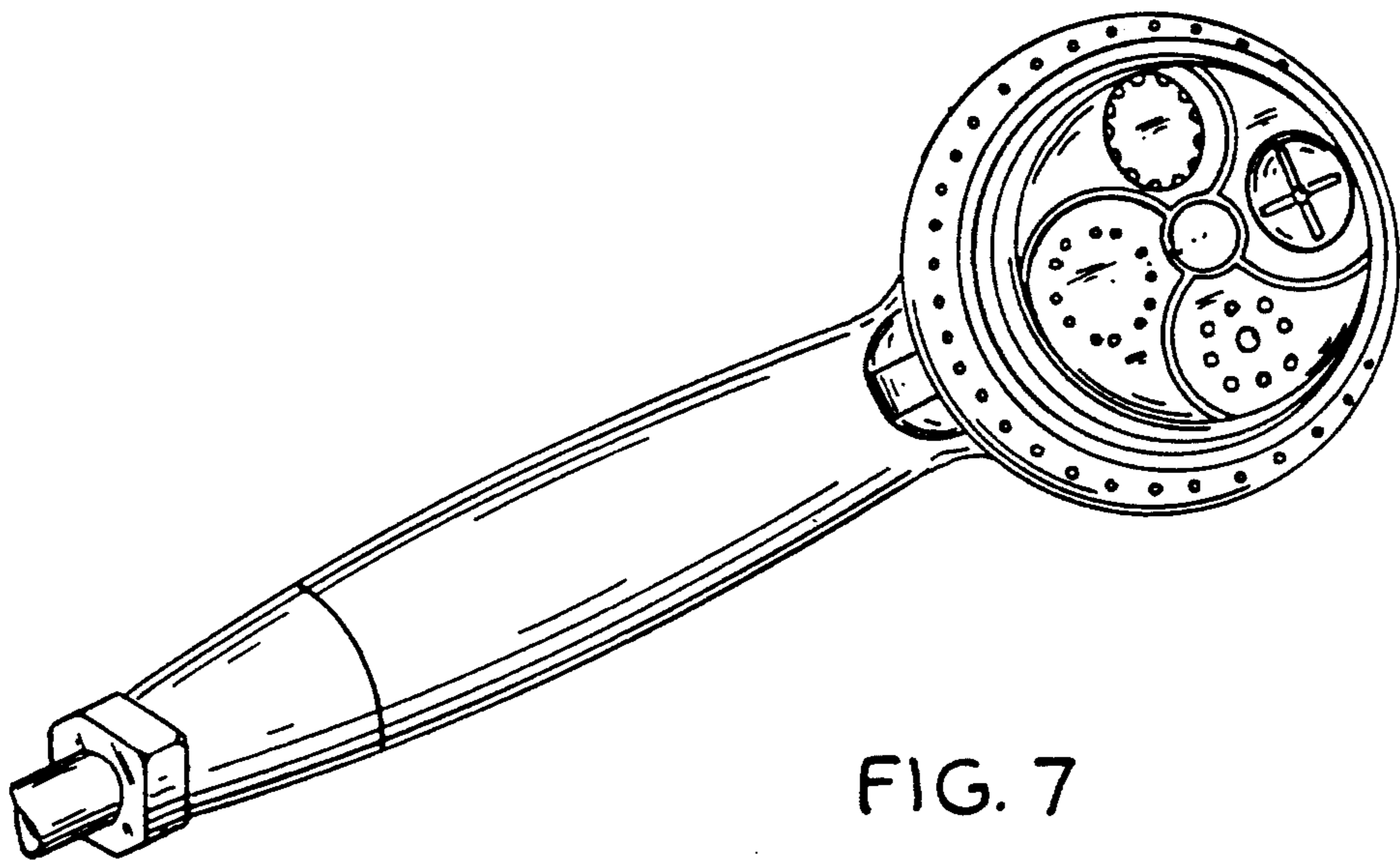

FIG. 7