



US00D344506S

United States Patent [19]

Ichikawa

[11] Patent Number: Des. 344,506

[45] Date of Patent: ** Feb. 22, 1994

[54] TELEVISION RECEIVER

[75] Inventor: Kazuo Ichikawa, Tokyo, Japan

[73] Assignee: Sony Corporation, Tokyo, Japan

[**] Term: 14 Years

[21] Appl. No.: 897,964

[22] Filed: Jun. 12, 1992

[30] Foreign Application Priority Data

Dec. 12, 1991 [JP] Japan 3-37531

[52] U.S. Cl. D14/126

[58] Field of Search 358/60, 237-239, 358/254-255; 312/7.2; D14/124-134, 299

[56] References Cited

U.S. PATENT DOCUMENTS

- D. 294,700 3/1988 Sakuta D14/126
- D. 298,245 10/1988 Nakamaru D14/126
- D. 303,257 9/1989 Kawata et al. D14/126
- D. 311,531 10/1990 Saeki et al. D14/126
- D. 319,229 8/1991 Hino et al. D14/126

Primary Examiner—Theodore M. Shooman

Attorney, Agent, or Firm—Lewis H. Eslinger; Jay H. Maioli

[57] CLAIM

The ornamental design for a television receiver, as shown and described.

DESCRIPTION

FIG. 1 is a top plan view of a television receiver, showing my new design;
 FIG. 2 is a left-side elevational view thereof;
 FIG. 3 is a front elevational view thereof;
 FIG. 4 is a right-side elevational view thereof;
 FIG. 5 is a rear elevational view thereof;
 FIG. 6 is a bottom plan view thereof;
 FIG. 7 is a top, front and right-side perspective view thereof;
 FIG. 8 is a top, rear and left-side perspective view thereof, shown with belt attached; and,
 FIG. 9 is a top, front and right-side perspective view thereof, shown with the aerial in an extended position. The broken line showing of the belt in FIG. 9 is for illustrative purposes only and forms no part of the claimed design.

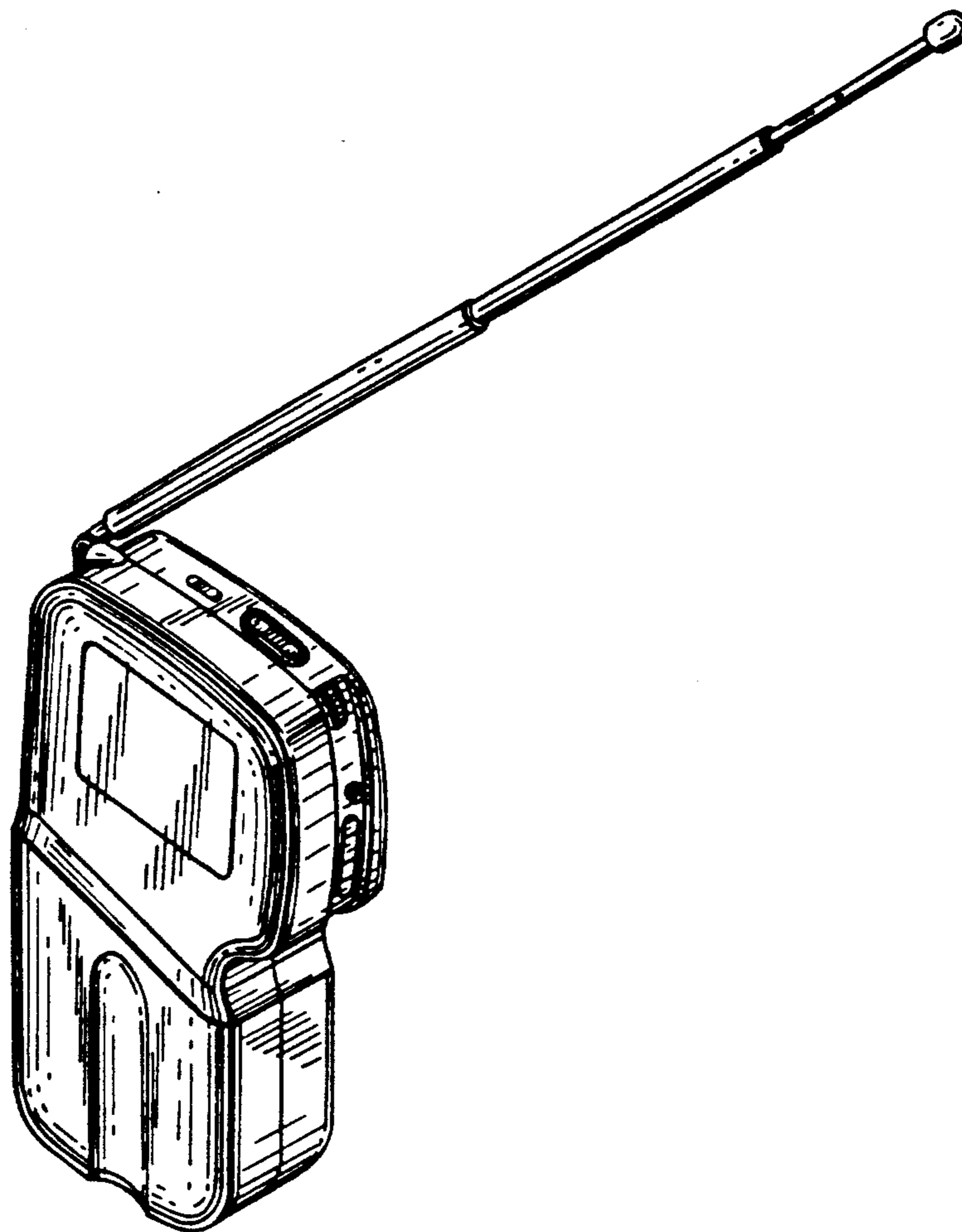

FIG. 1

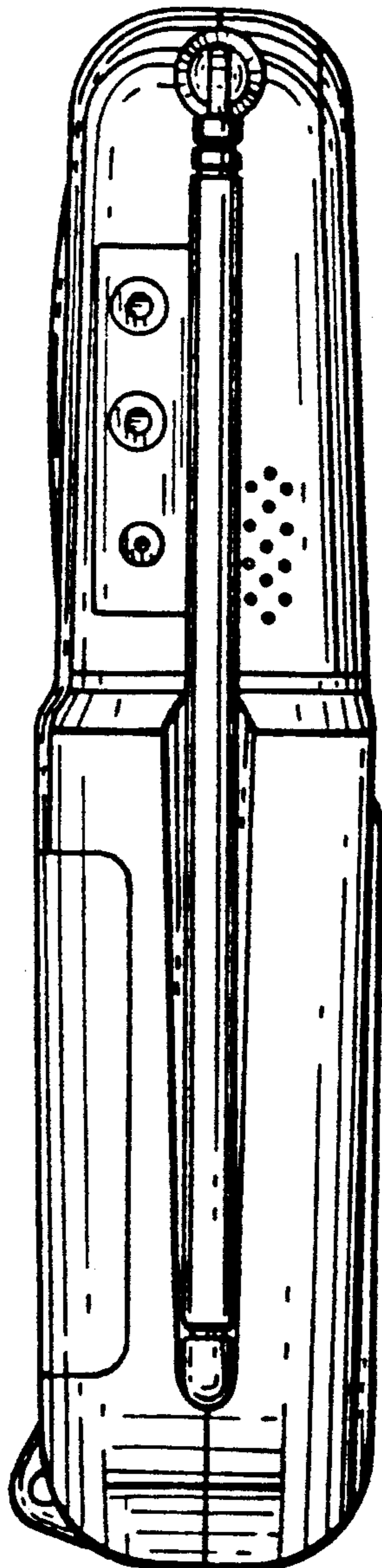
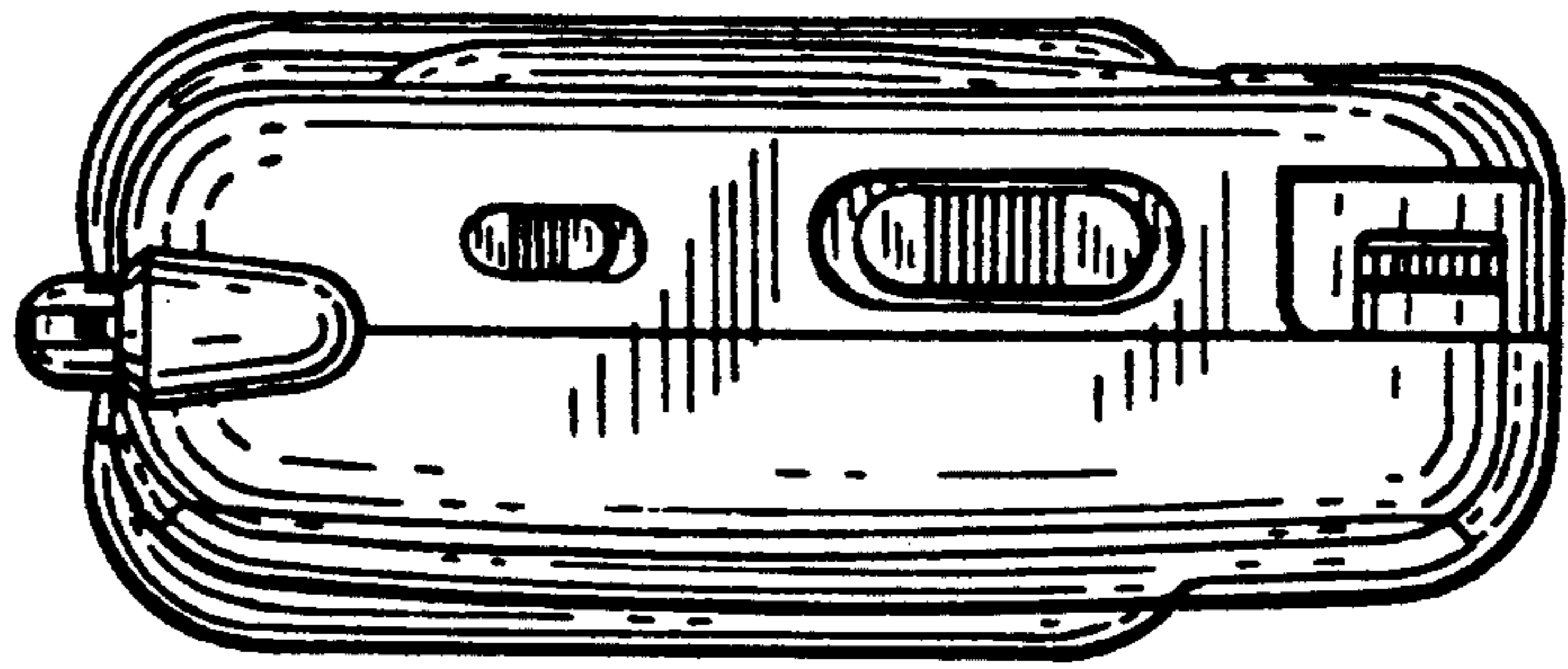

FIG. 2

FIG.3

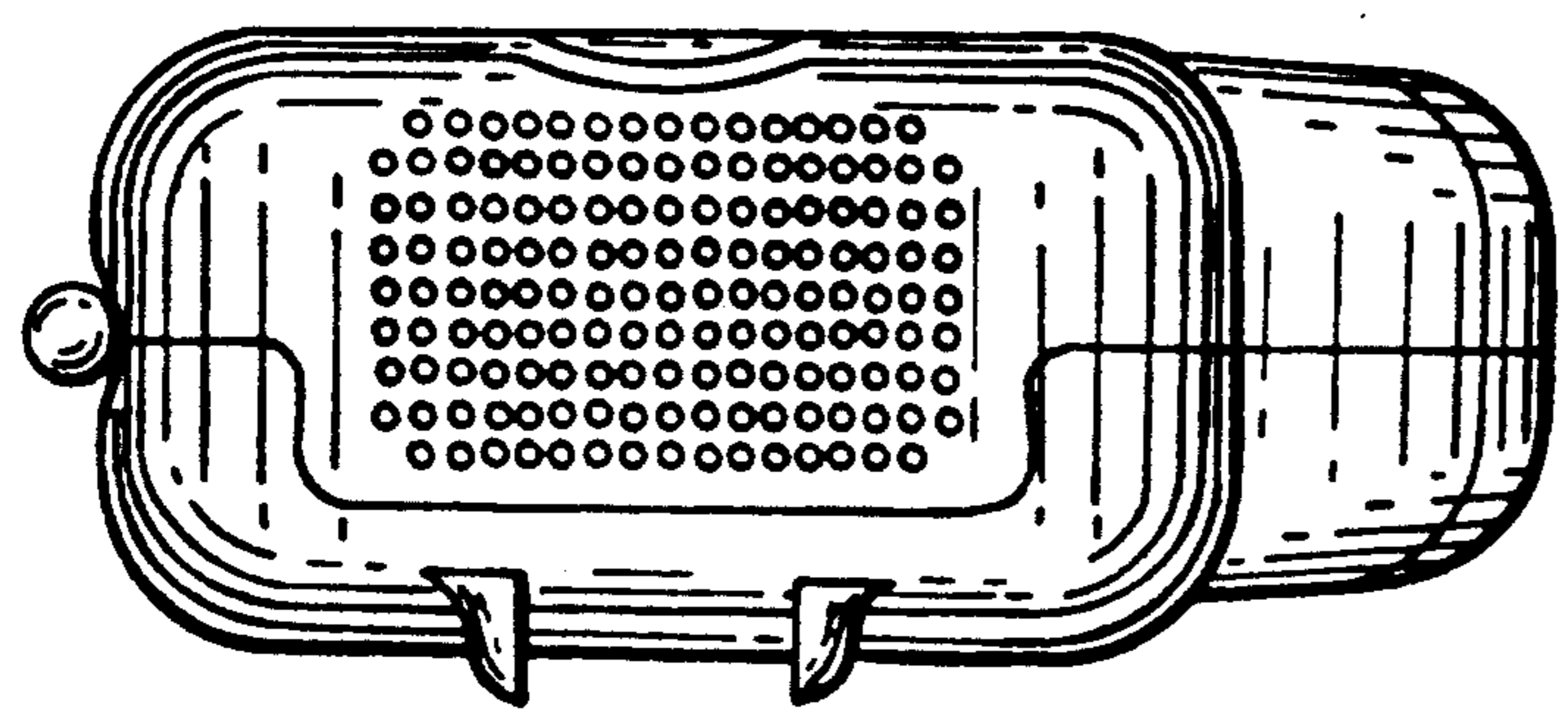
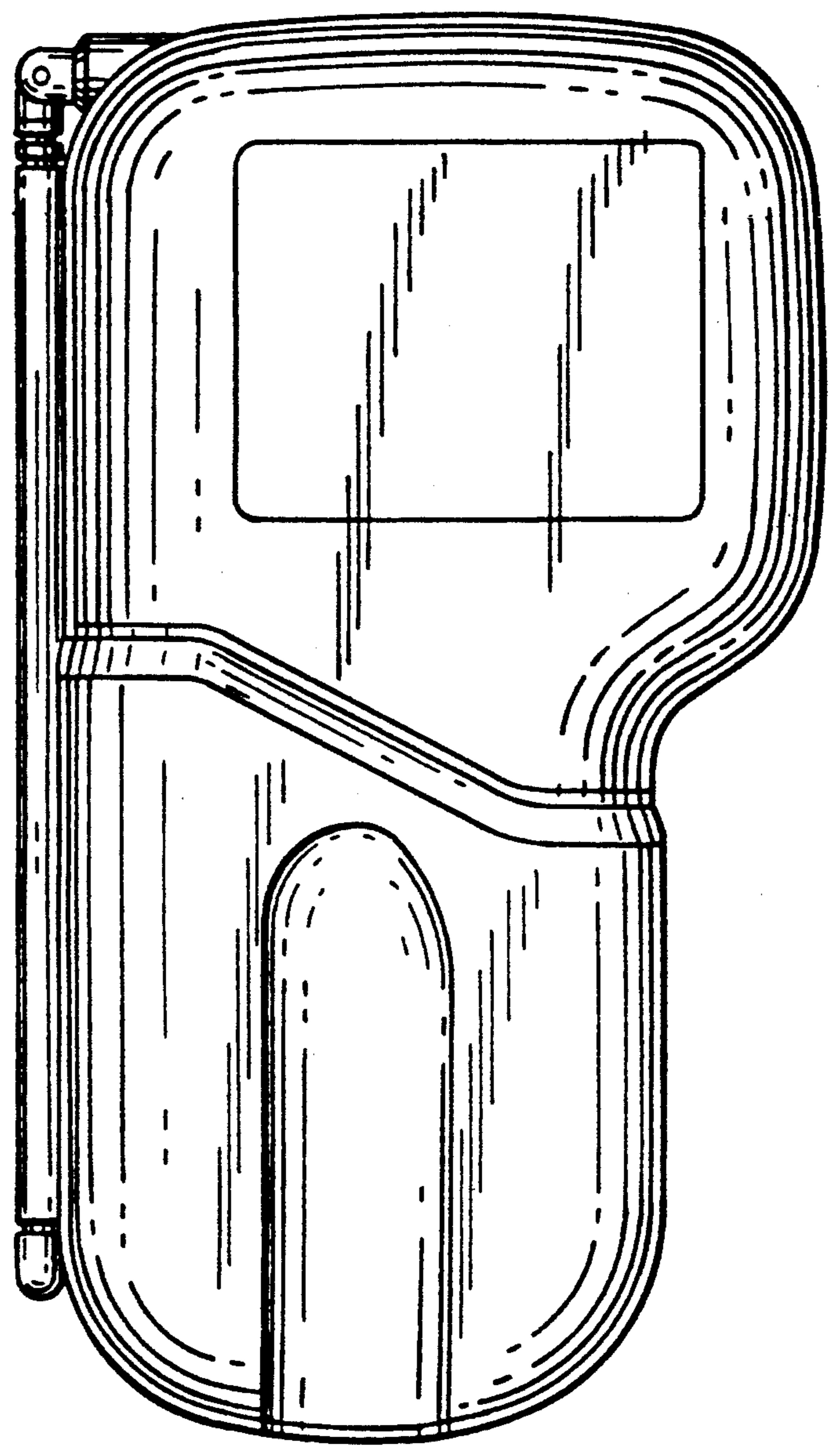

FIG.6

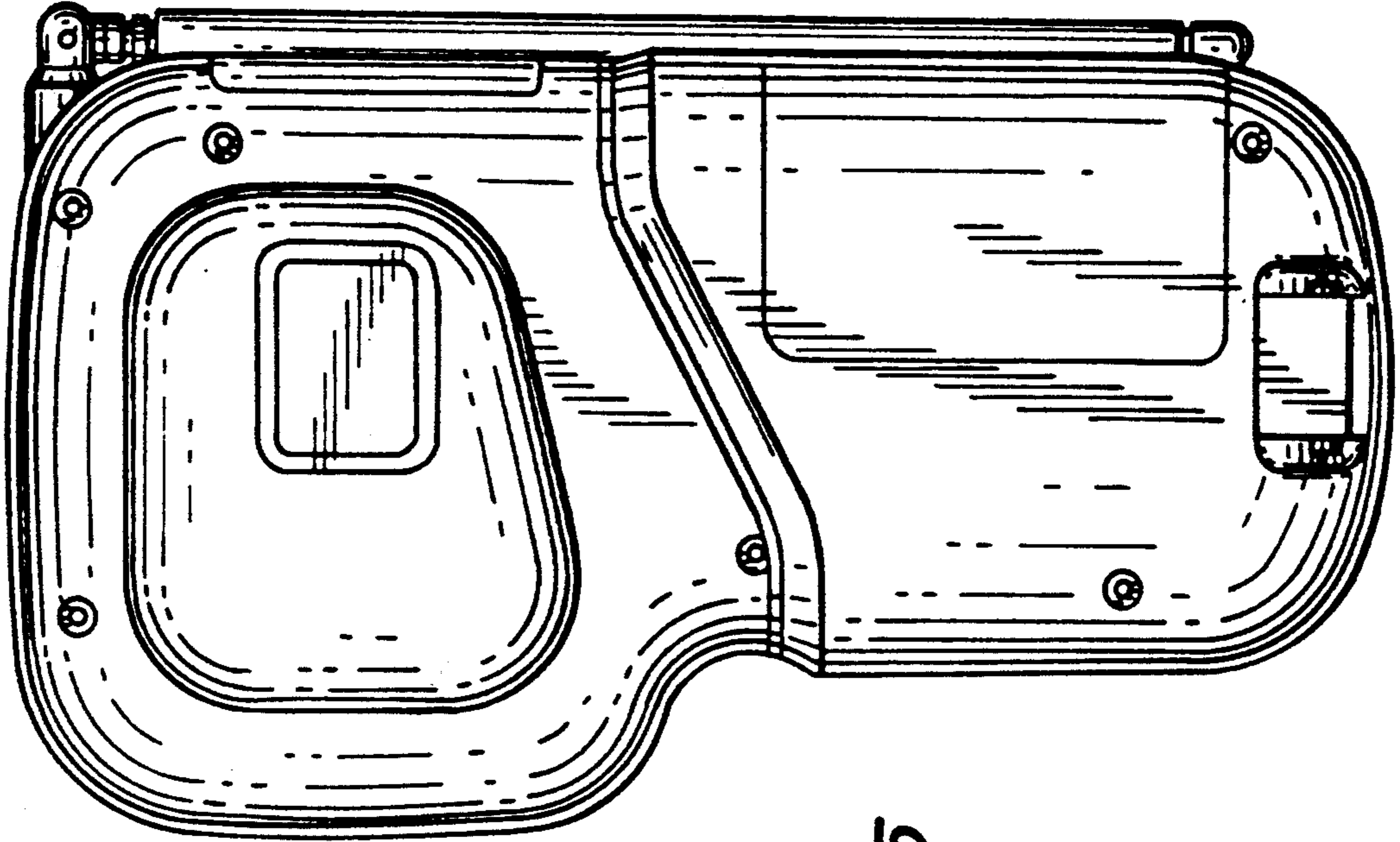

FIG. 5

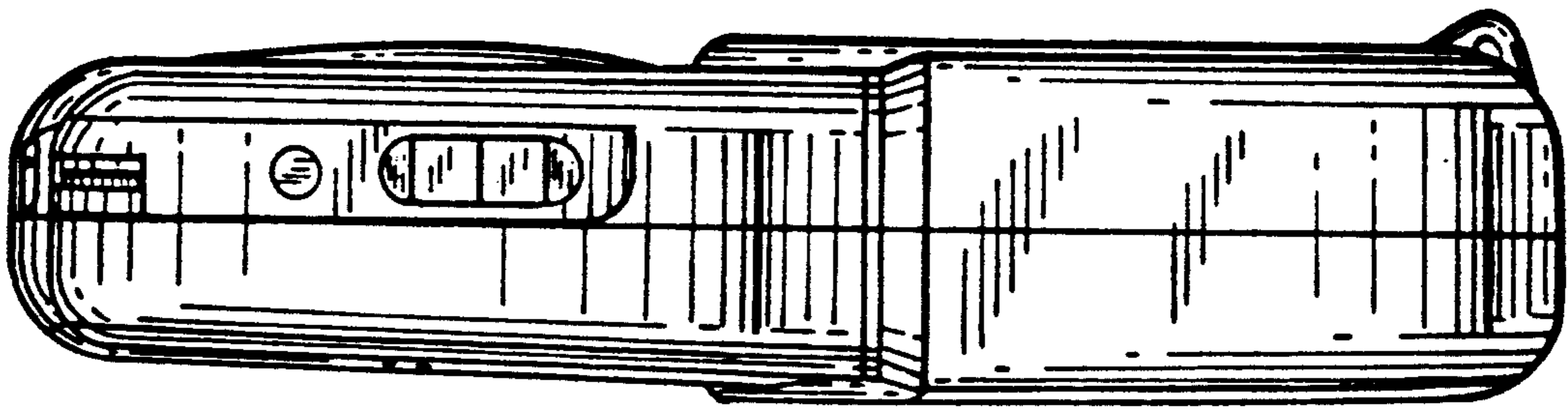

FIG. 4

FIG.7

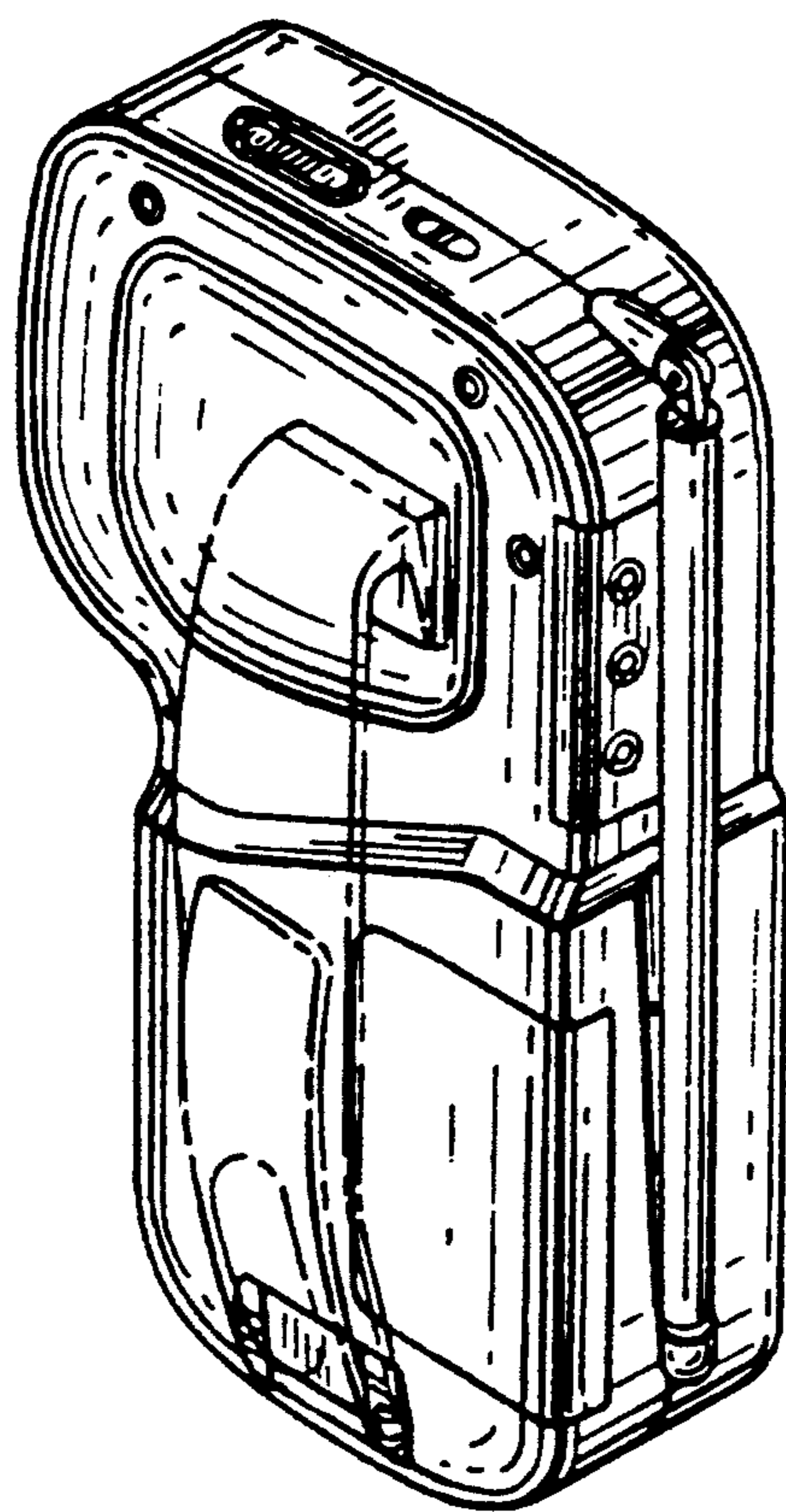
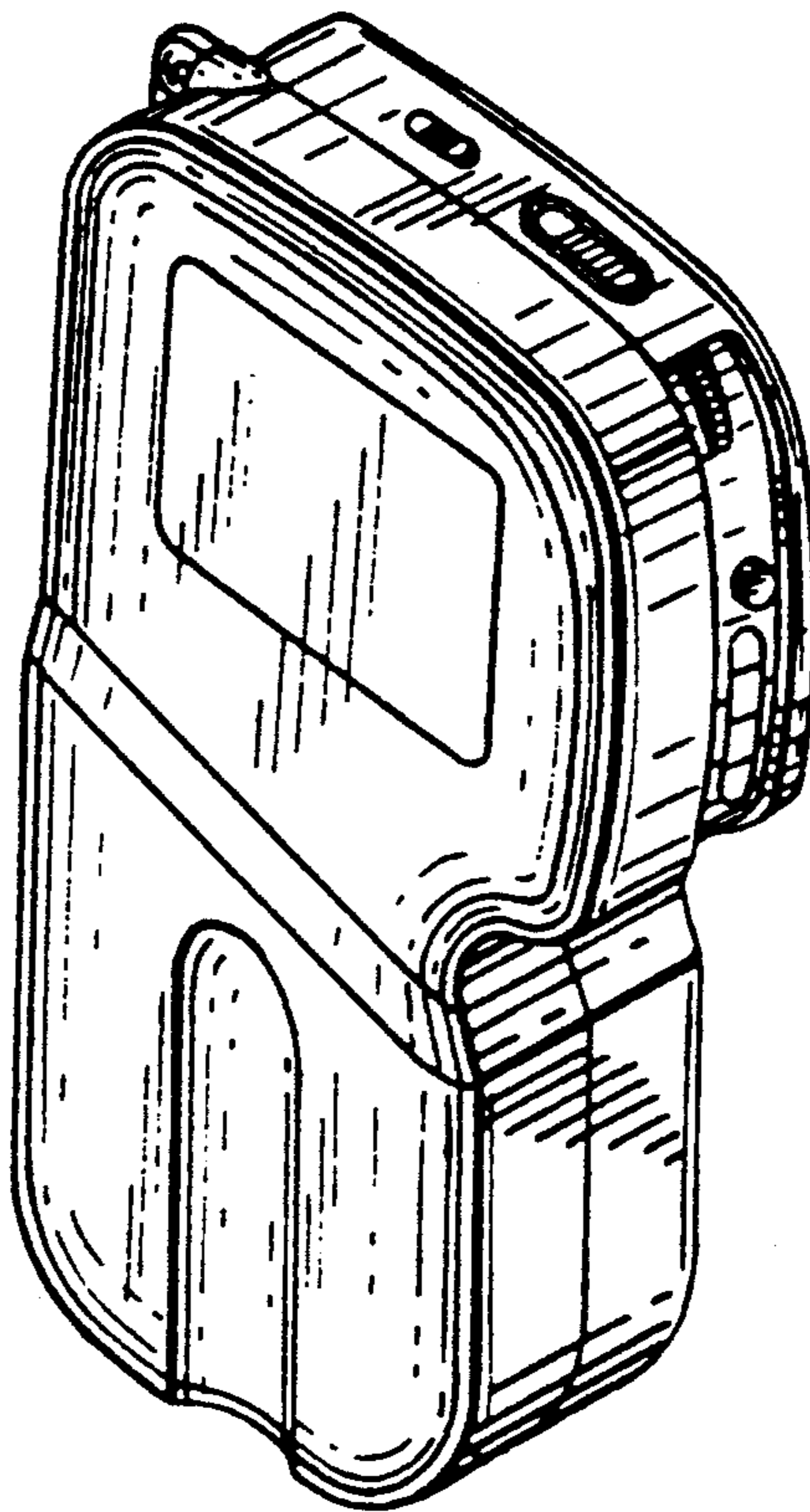

FIG.8

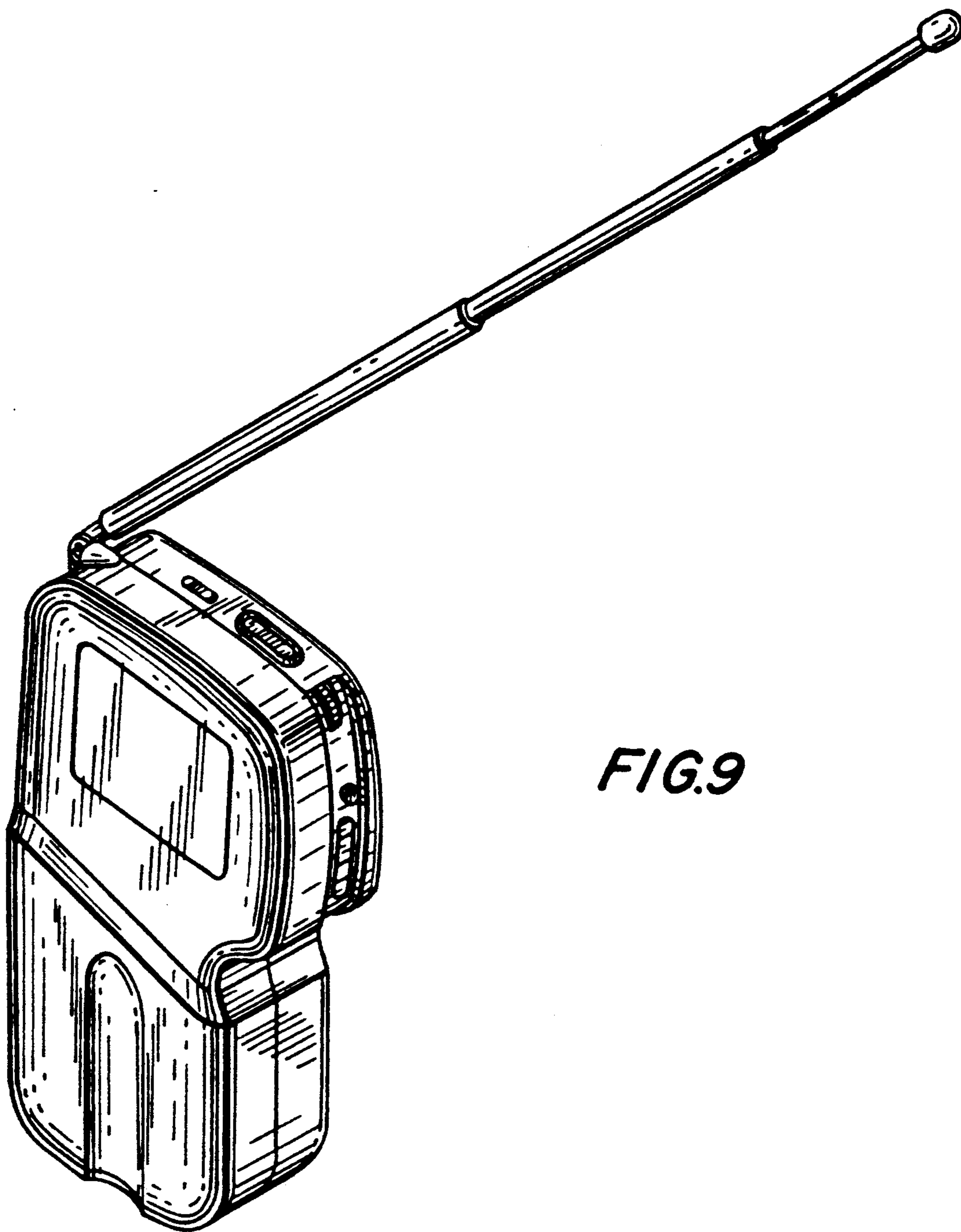

FIG.9