



US00D344491S

United States Patent [19] Nakamura

[11] Patent Number: **Des. 344,491**

[45] Date of Patent: **** Feb. 22, 1994**

[54] **ELECTRICAL CONNECTING PLUG**

[75] Inventor: **Masahiko Nakamura, Yao, Japan**

[73] Assignee: **Hosiden Corporation, Yao, Japan**

[**] Term: **14 Years**

[21] Appl. No.: **842,589**

[22] Filed: **Feb. 27, 1992**

[30] **Foreign Application Priority Data**

Sep. 3, 1991 [JP] Japan 3-26654

[52] U.S. Cl. **D13/147**

[58] Field of Search 439/350, 352, 357, 358,
439/609, 638, 678, 680, 682, 686, 687, 692;
D13/133, 147

[56] **References Cited**

U.S. PATENT DOCUMENTS

- D. 316,081 4/1991 Tsubokura et al. D13/147
- D. 319,998 9/1991 Kozono D13/133
- 4,354,719 10/1982 Weidler 439/687 X
- 4,898,548 2/1990 Case et al. 439/686

- 4,915,642 4/1990 Lin et al. 439/350 X
- 4,983,127 1/1991 Kawai et al. 439/609 X
- 5,082,455 1/1992 Wei 439/352

FOREIGN PATENT DOCUMENTS

0879344 10/1961 United Kingdom 439/680

Primary Examiner—Wallace R. Burke

Assistant Examiner—Joel Sincavage

Attorney, Agent, or Firm—Jones, Tullar & Cooper

[57] **CLAIM**

The ornamental design for an electrical connecting plug, as shown and described.

DESCRIPTION

FIG. 1 is a front, top and right side perspective view of an electrical connecting plug showing my new design; FIG. 2 is a front elevational view thereof; FIG. 3 is a rear elevational view thereof; FIG. 4 is a right side elevational view thereof, the left side elevational view being a mirror image; FIG. 5 is a top plan view thereof; FIG. 6 is a bottom plan view thereof; and, FIG. 7 is a rear and upper left perspective view thereof.

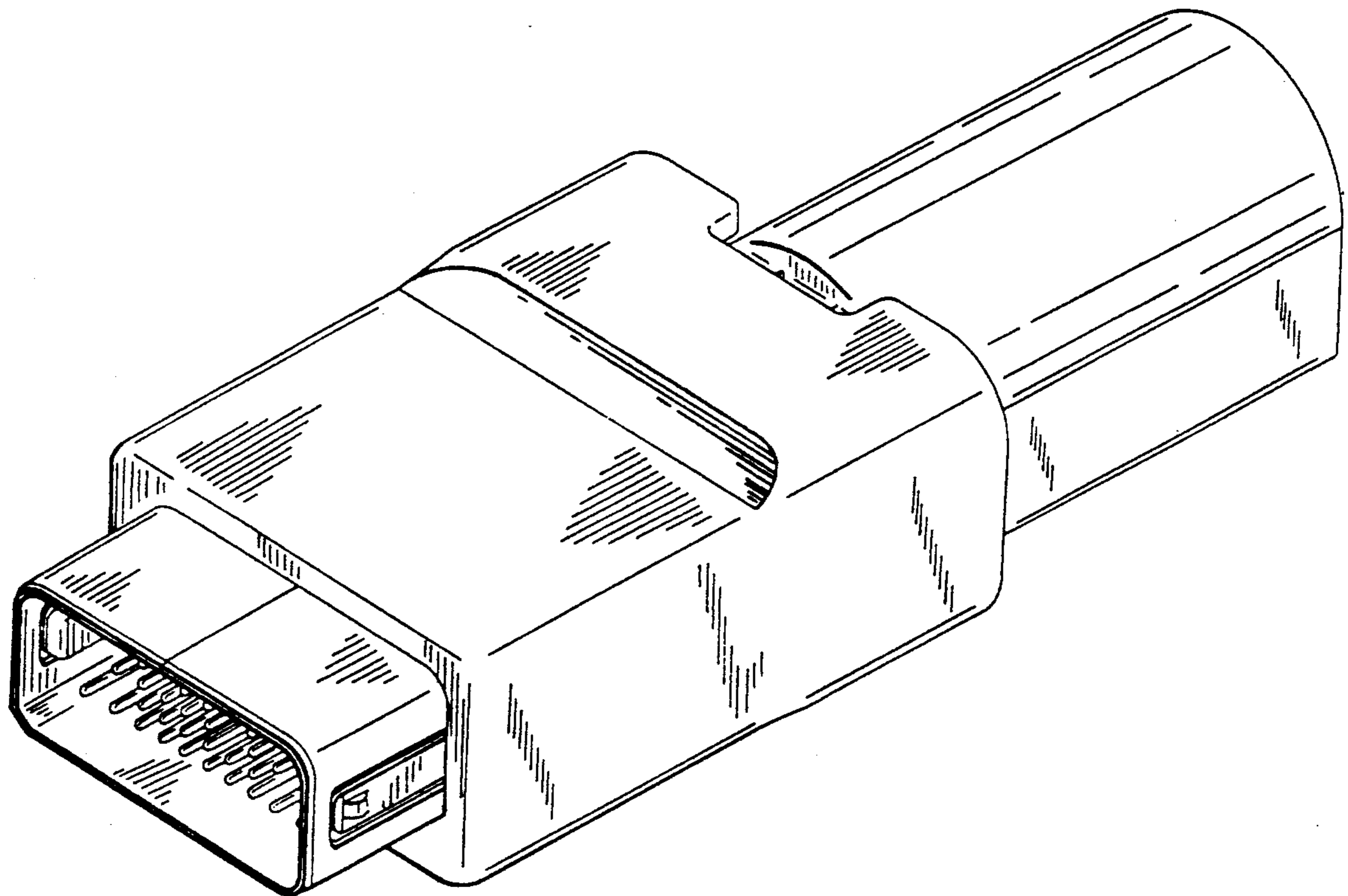

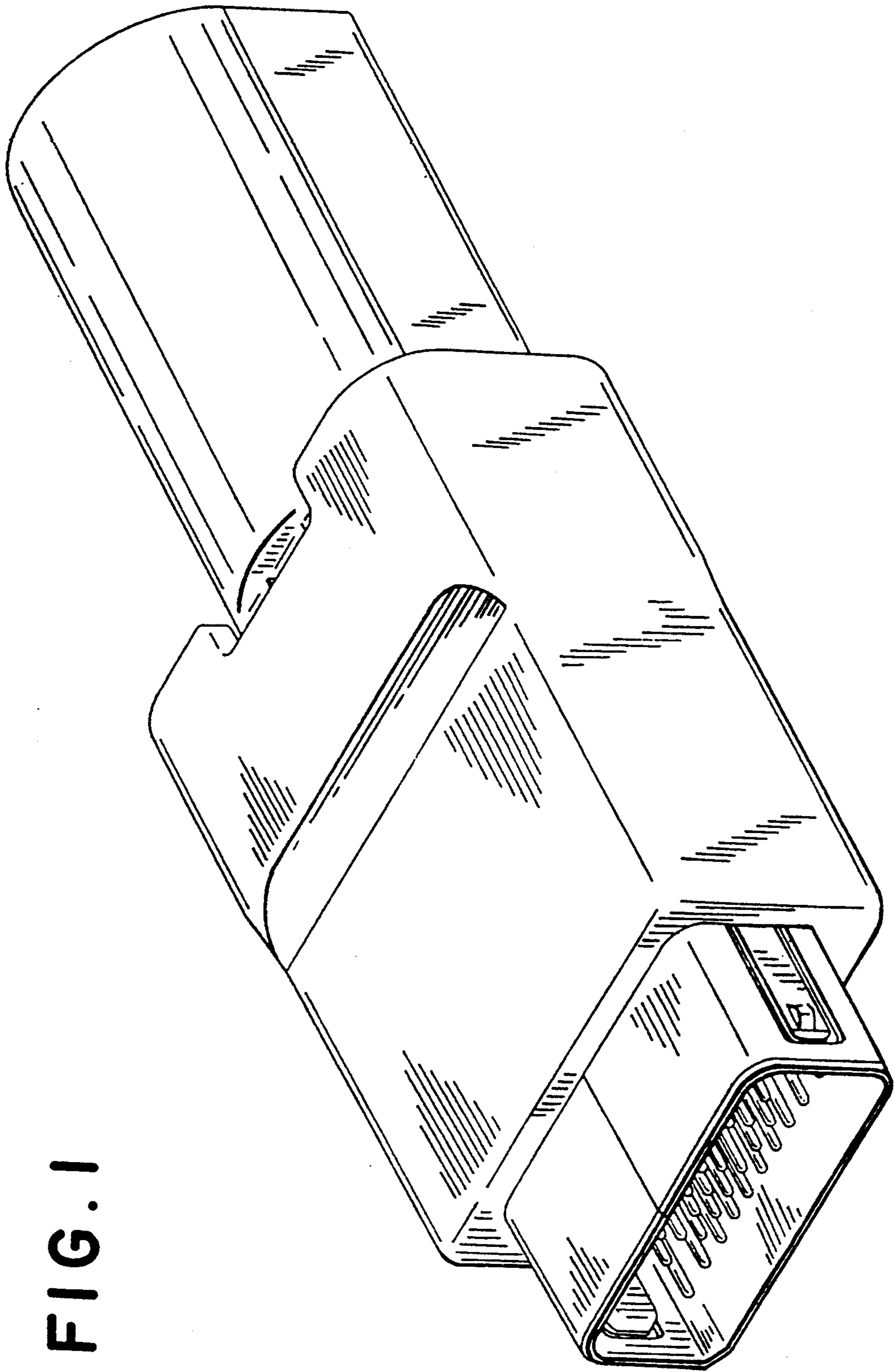
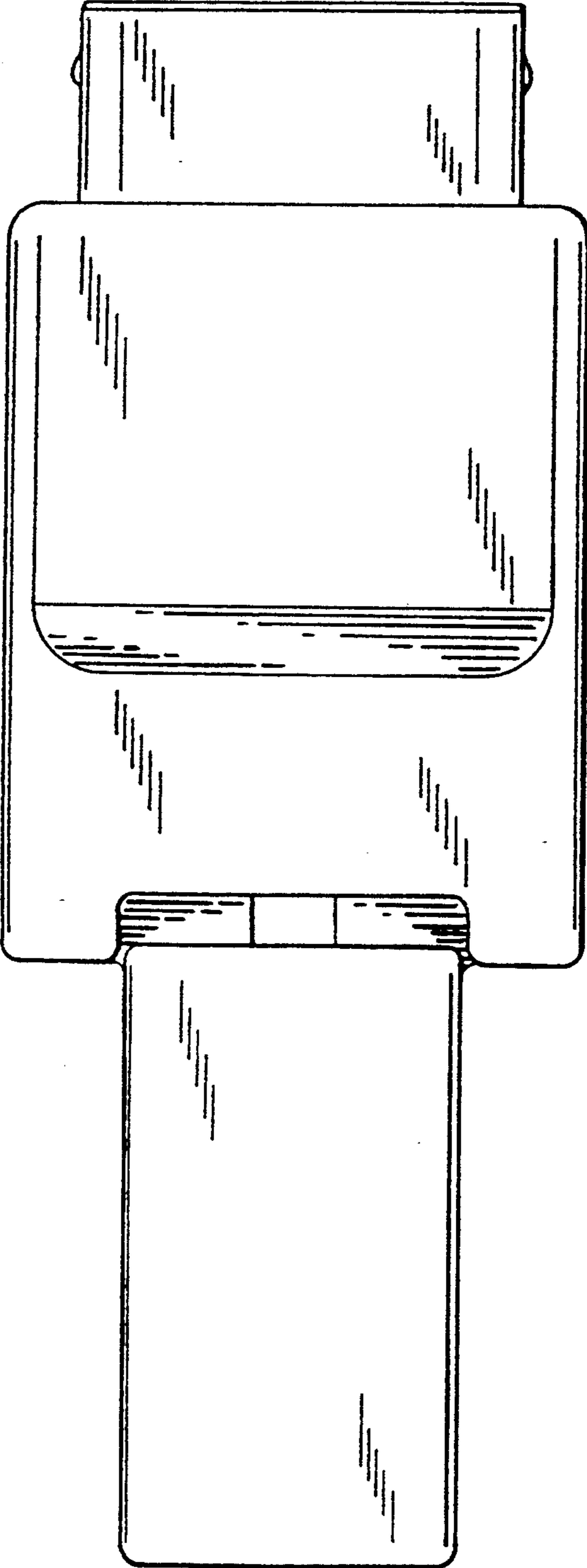

FIG. 1

FIG. 2



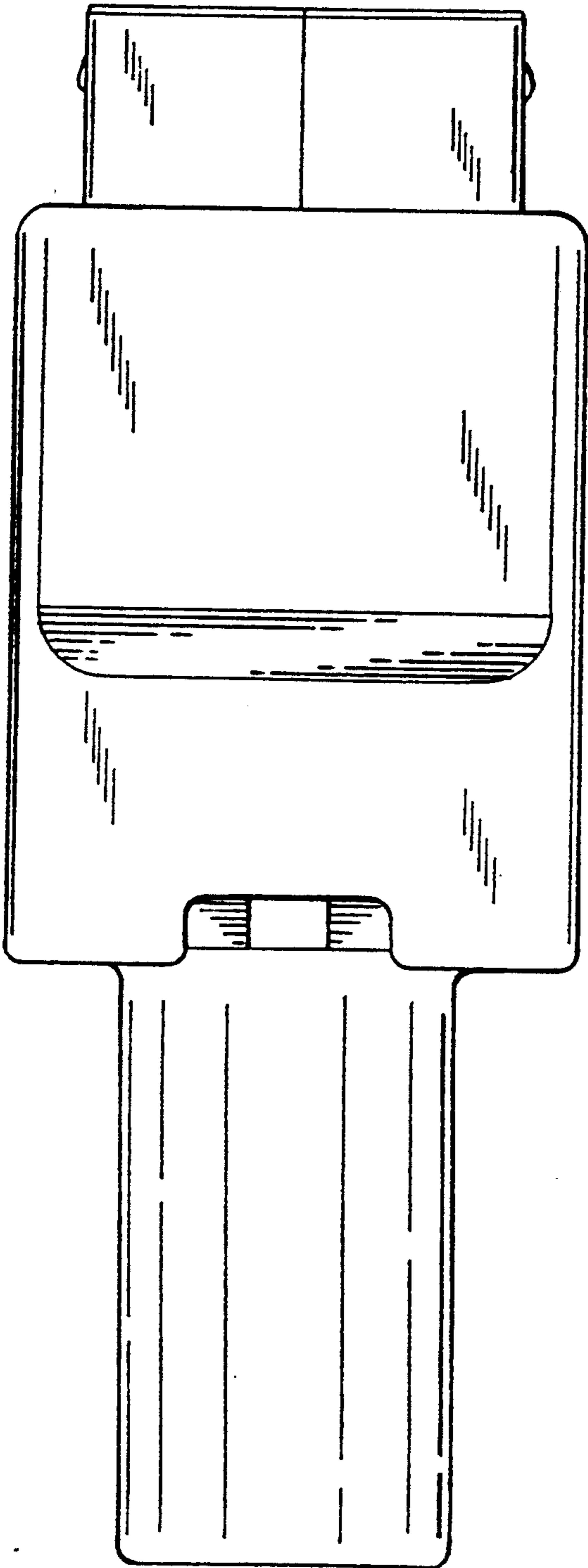

FIG. 3

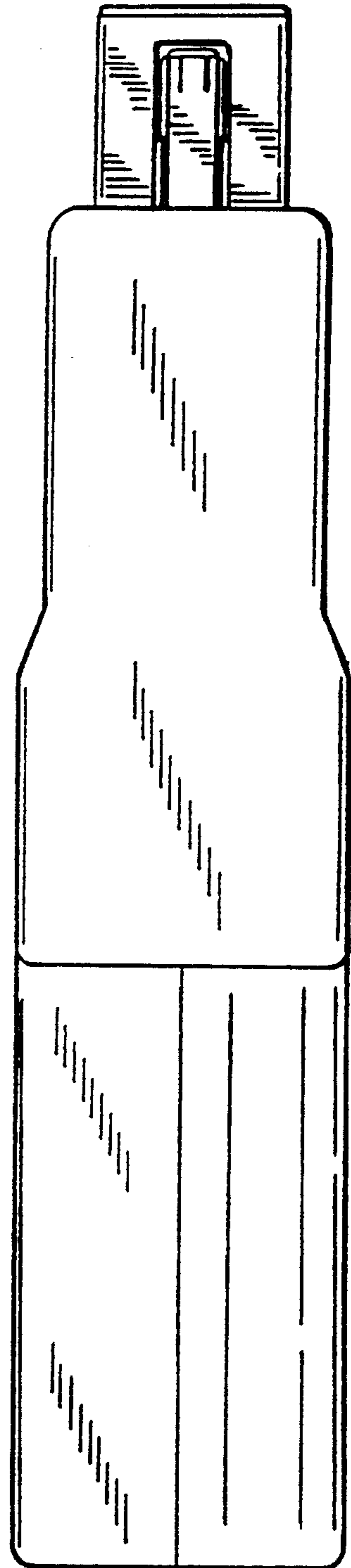

FIG. 4

FIG. 5

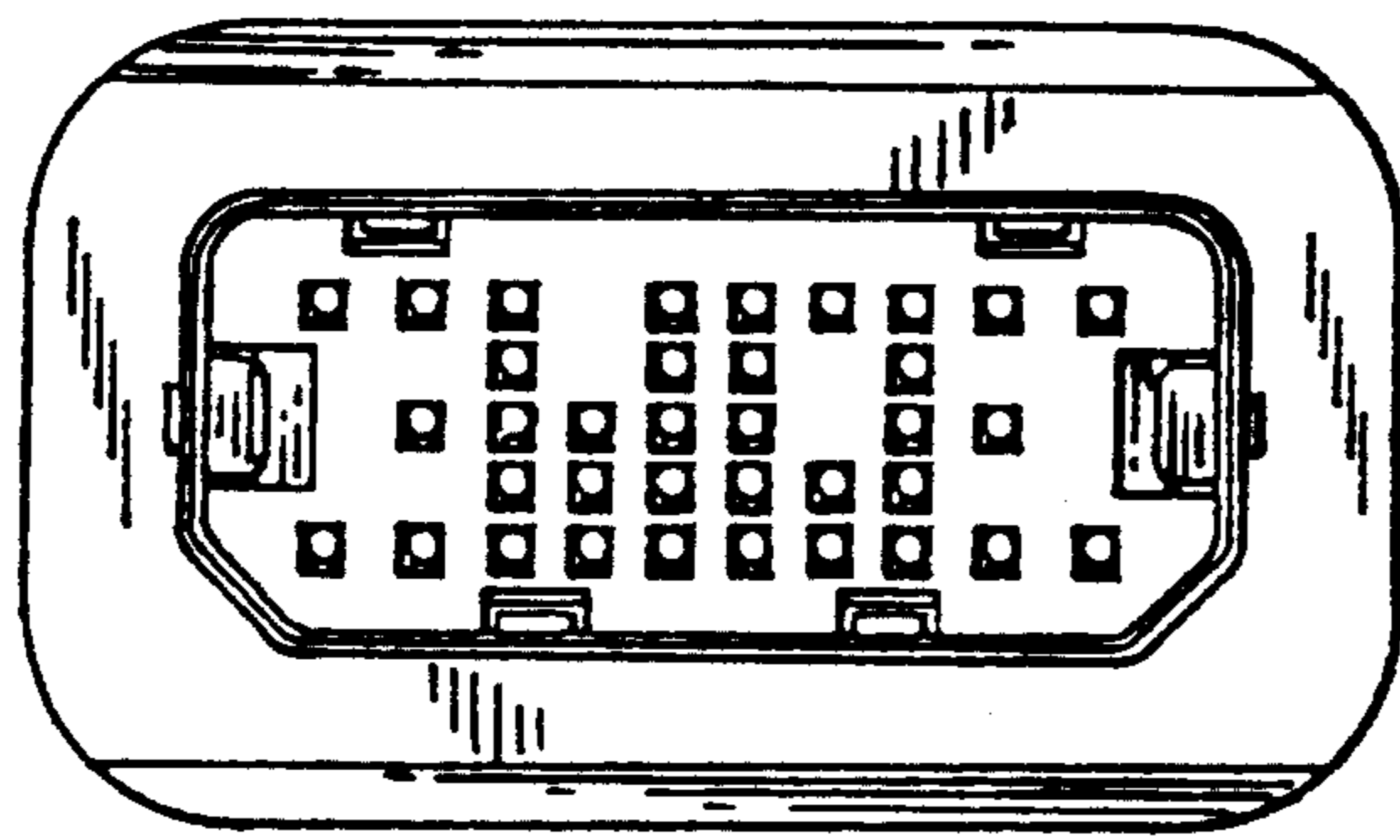
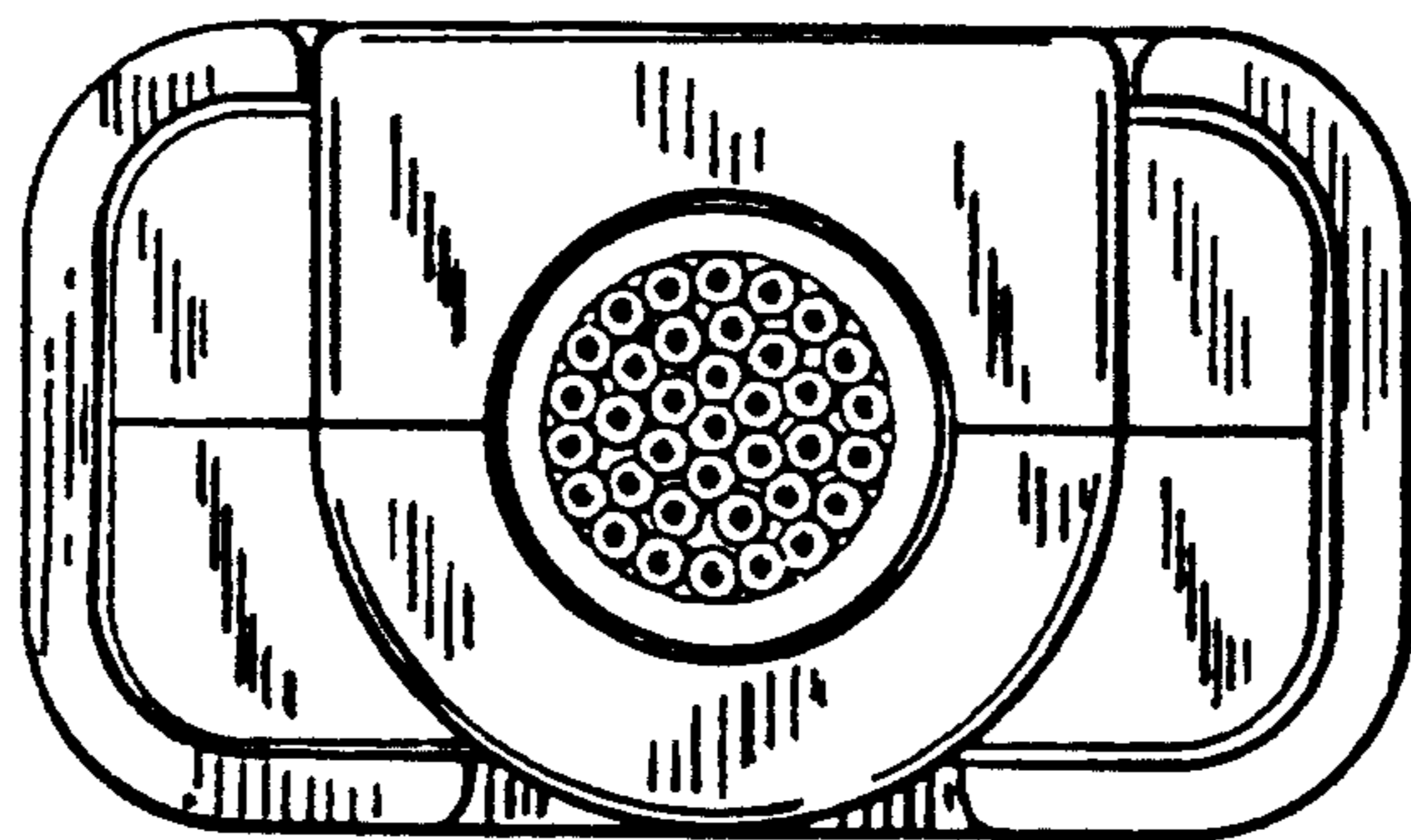

FIG. 6



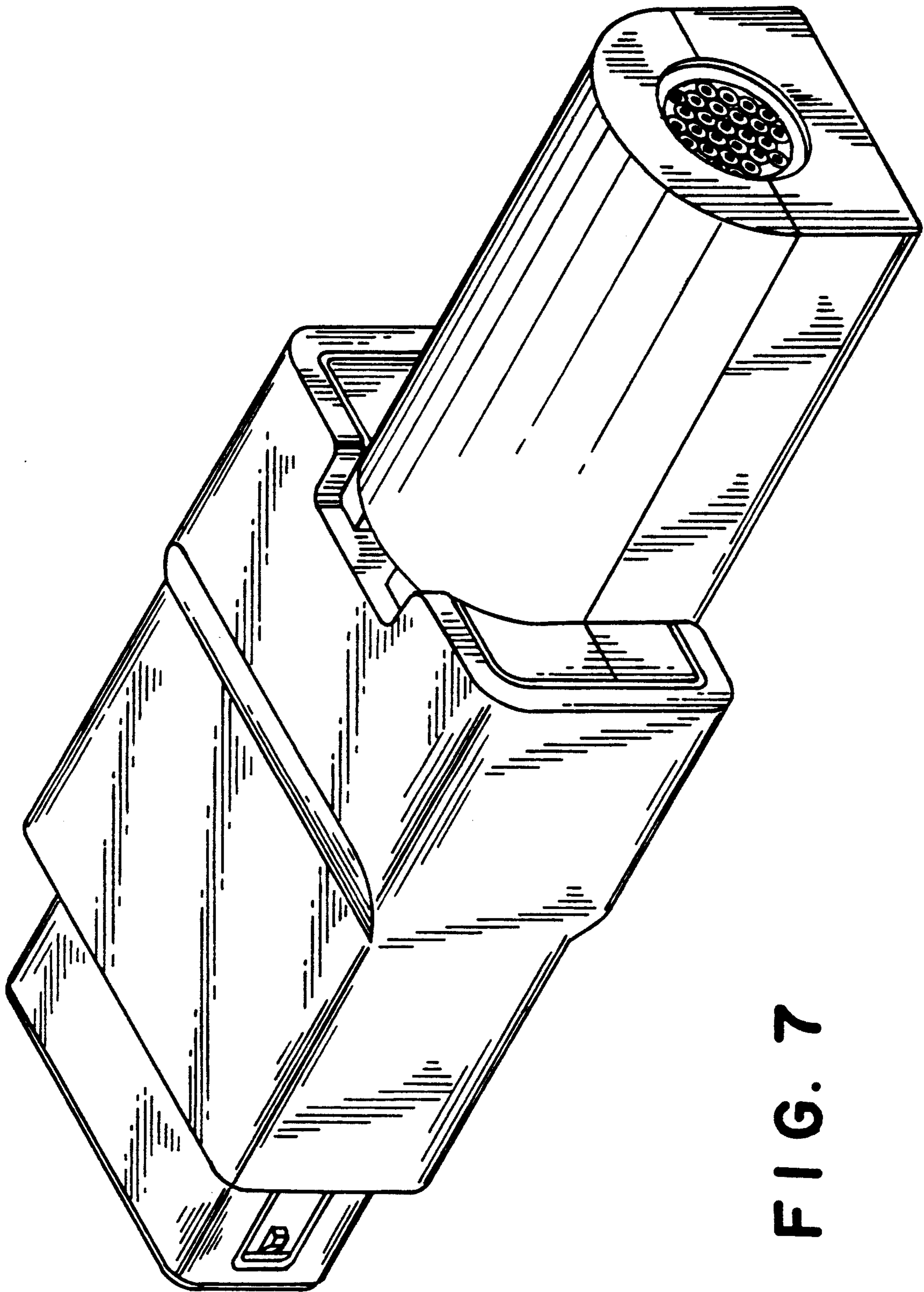

FIG. 7