



US00D344412S

# United States Patent [19] Barnhart

[11] Patent Number: Des. 344,412

[45] Date of Patent: \*\* Feb. 22, 1994

[54] PORTABLE COSMETIC CASE

5,054,505 10/1991 Yuhara ..... 132/304 XR

[76] Inventor: Nicholas W. Barnhart, P.O. Box 562,  
Blackfoot, Id. 83221

Primary Examiner—A. Hugo Word  
Assistant Examiner—Doris V. Coles  
Attorney, Agent, or Firm—Hopkins, French, Crockett,  
Springer & Hoopes

[\*\*] Term: 14 Years

[21] Appl. No.: 805,836

[57] CLAIM

[22] Filed: Dec. 11, 1991

The ornamental design for a portable cosmetic case, as shown and described.

[52] U.S. Cl. .... D3/275; D28/77;  
D3/293; D3/901

### DESCRIPTION

[58] Field of Search ..... D3/100, 106, 39;  
206/235, 581, 818; 132/304, 313, 315, 316, 294;  
224/226, 227, 228; D28/73, 77

FIG. 1 is a front elevation view of a portable cosmetic case, showing my new design;

FIG. 2 is a left side elevation thereof, the right side elevation being a mirror image;

FIG. 3 is a back view thereof;

FIG. 4 is a prospective view thereof, having a cover removed from the portable cosmetic case;

FIG. 5 is a bottom view thereof; and,

FIG. 6 is a front view thereof having the cover installed on the portable cosmetic case.

The broken line showing of cosmetics in FIG. 1 is for illustrative purposes only and forms no part of the claimed design.

### [56] References Cited

#### U.S. PATENT DOCUMENTS

D. 139,041	10/1944	Morrison	.....	D28/77
D. 212,401	10/1968	Sanford	.....	D3/39
D. 275,425	9/1984	Briggs	.....	D3/39 XR
2,315,095	3/1943	Rhodes	.....	D3/106 XR
4,388,935	6/1983	Napolitane	.....	132/294
4,526,273	7/1985	Tsuji et al.	.....	206/235 XR
4,562,923	1/1986	Katada et al.	.....	206/235
4,580,586	4/1986	Kitoh et al.	.....	132/315

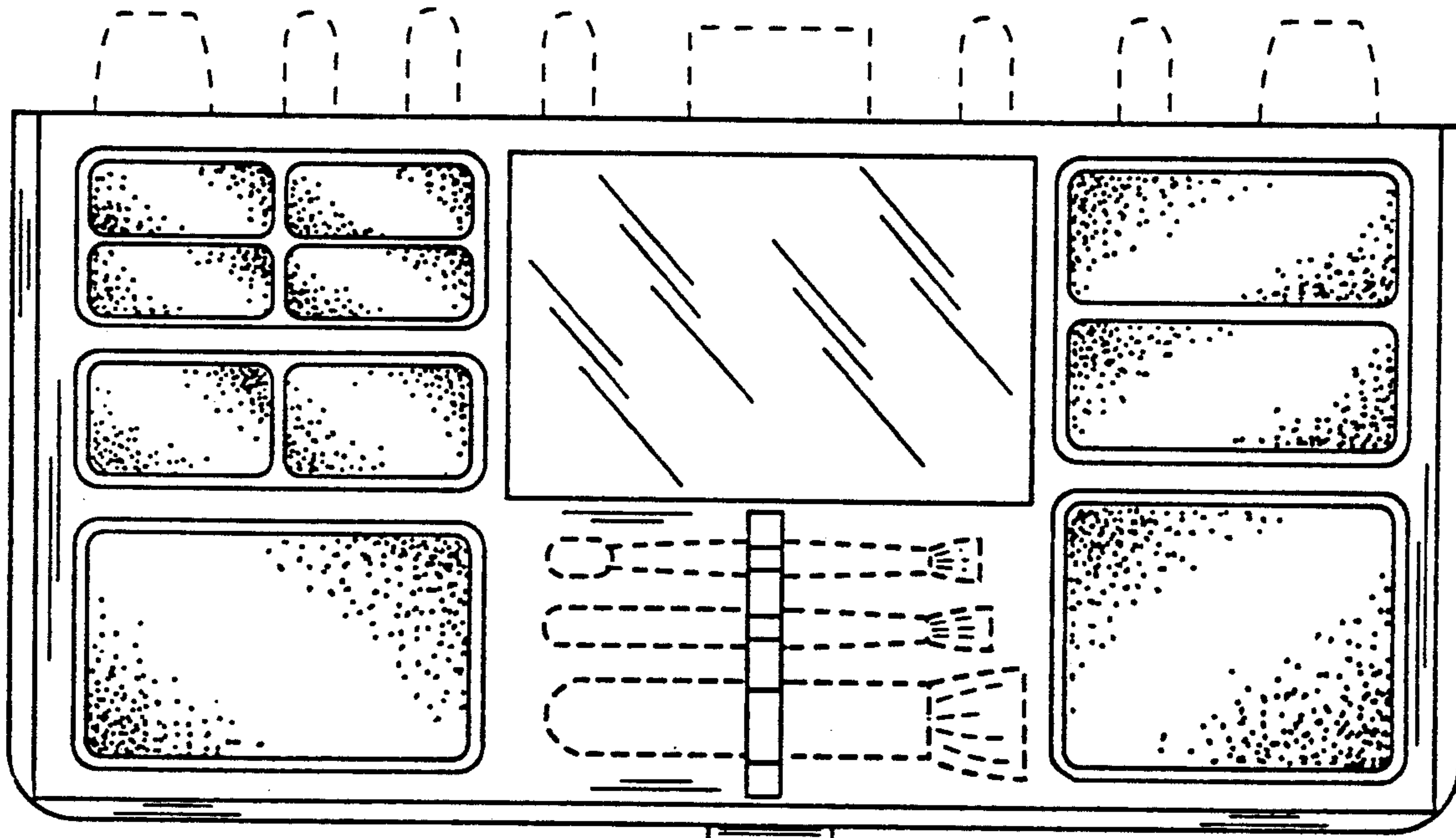

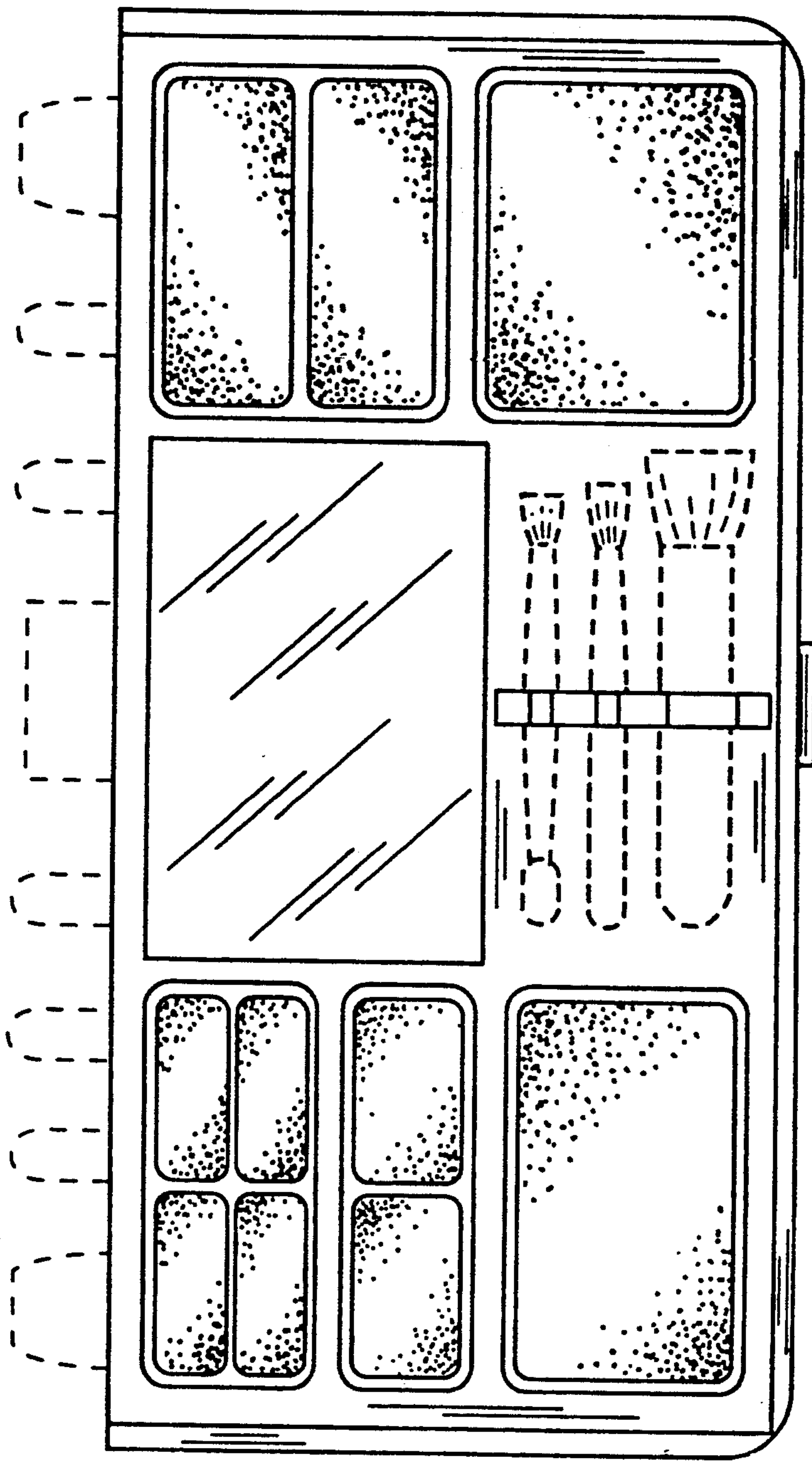

FIG.1

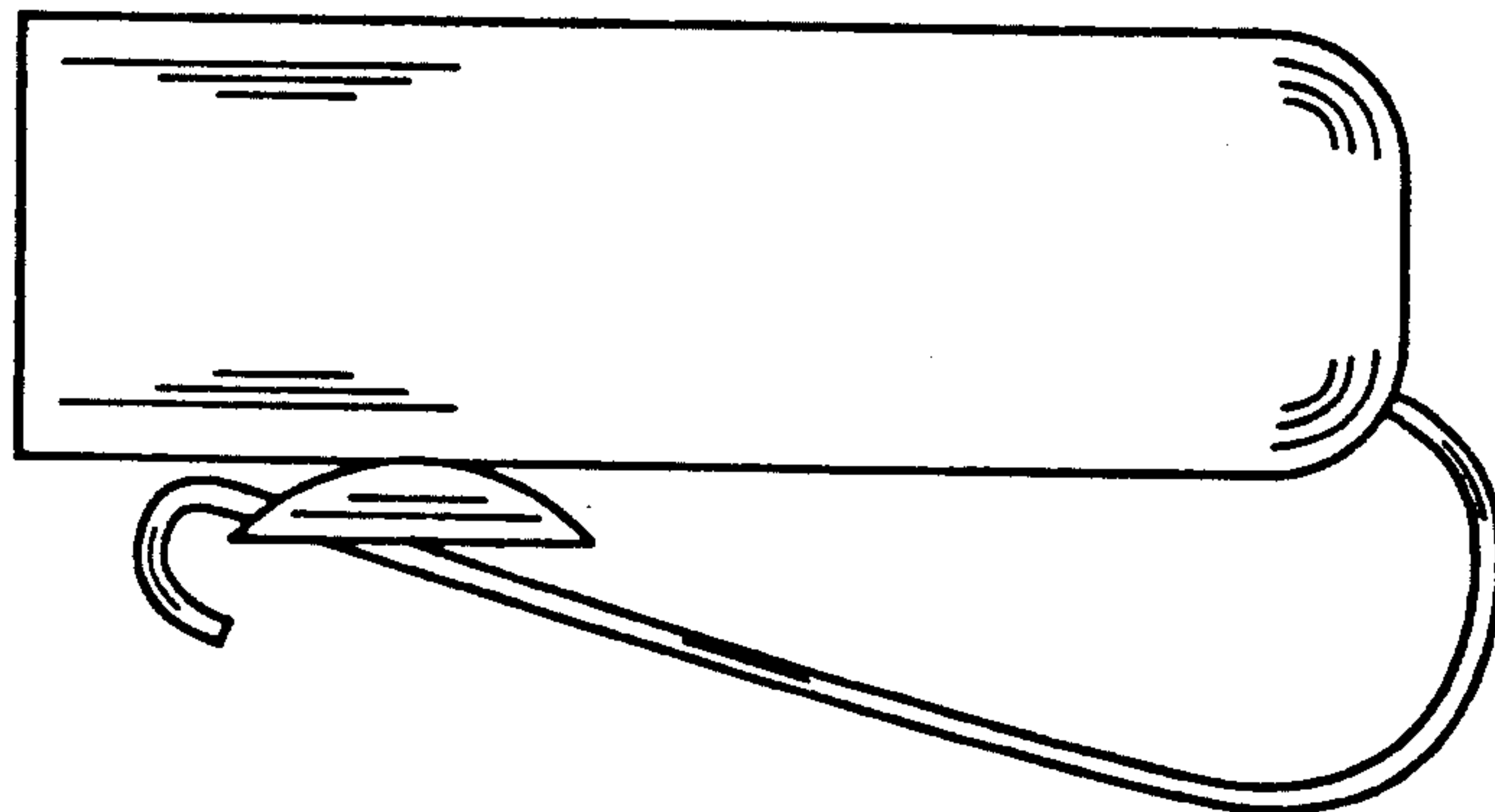

FIG.2

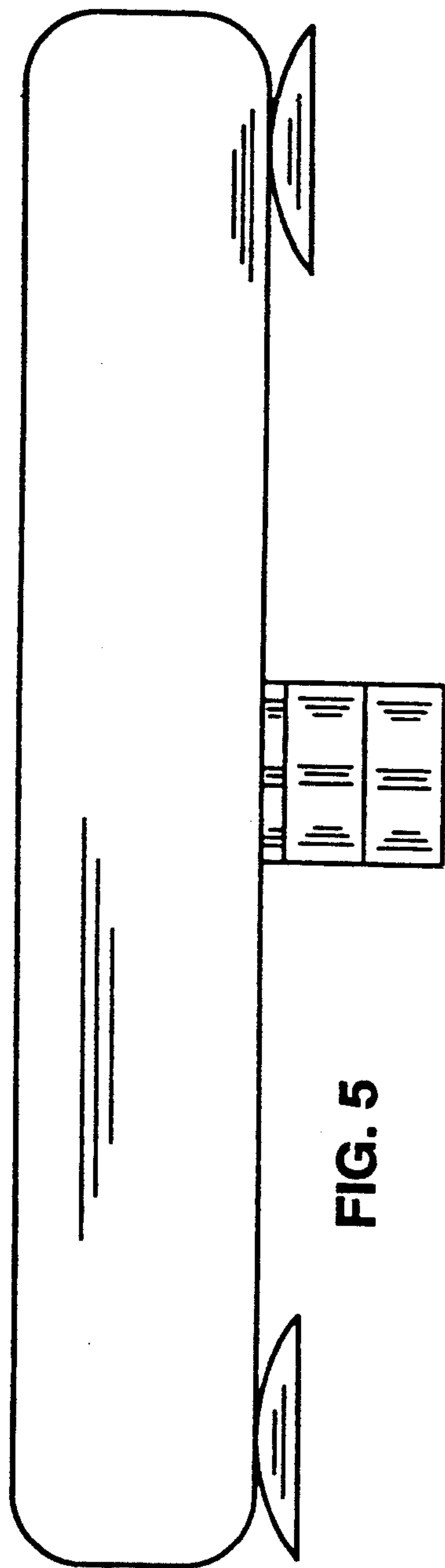

FIG. 5

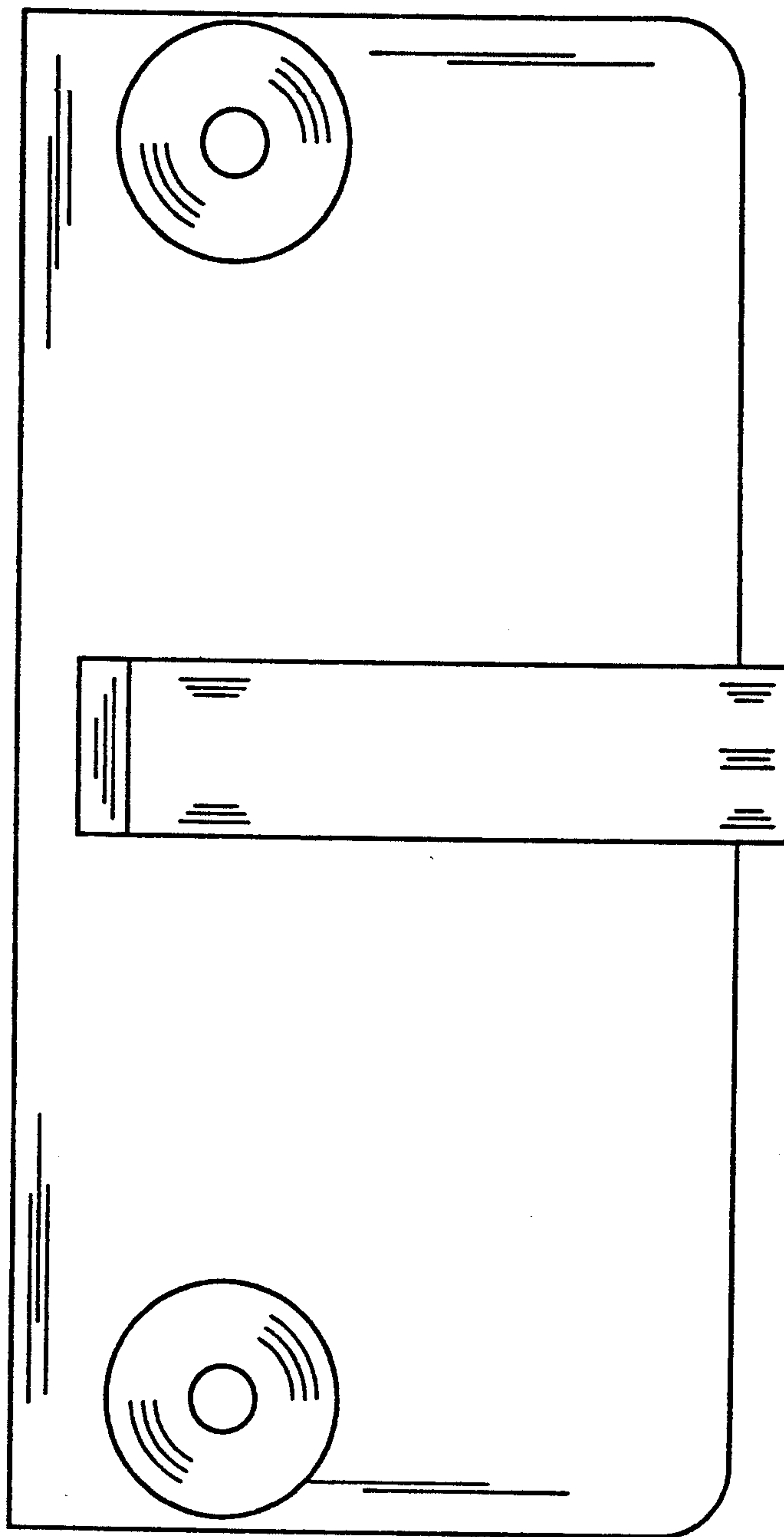

FIG. 3



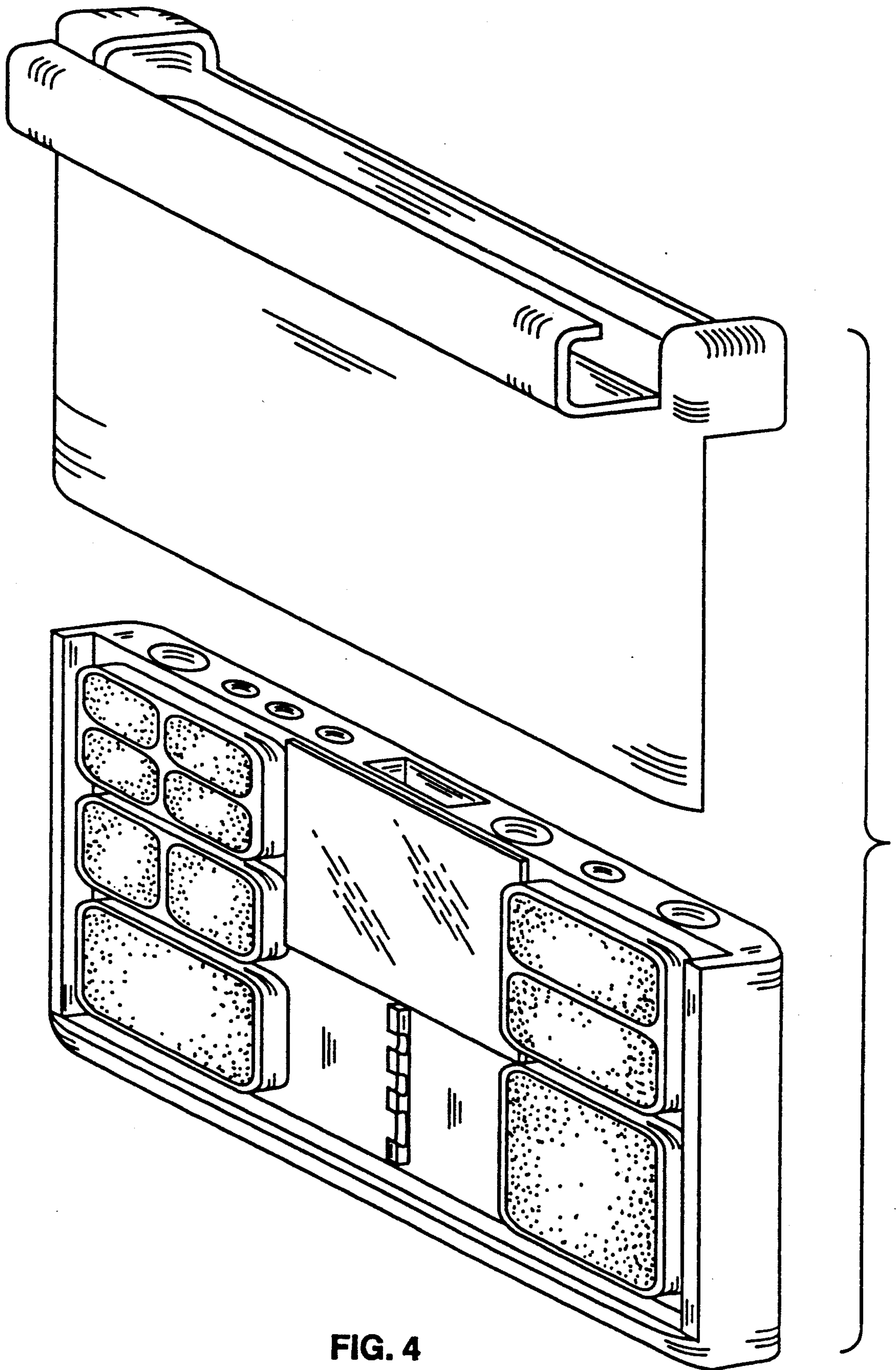

FIG. 4

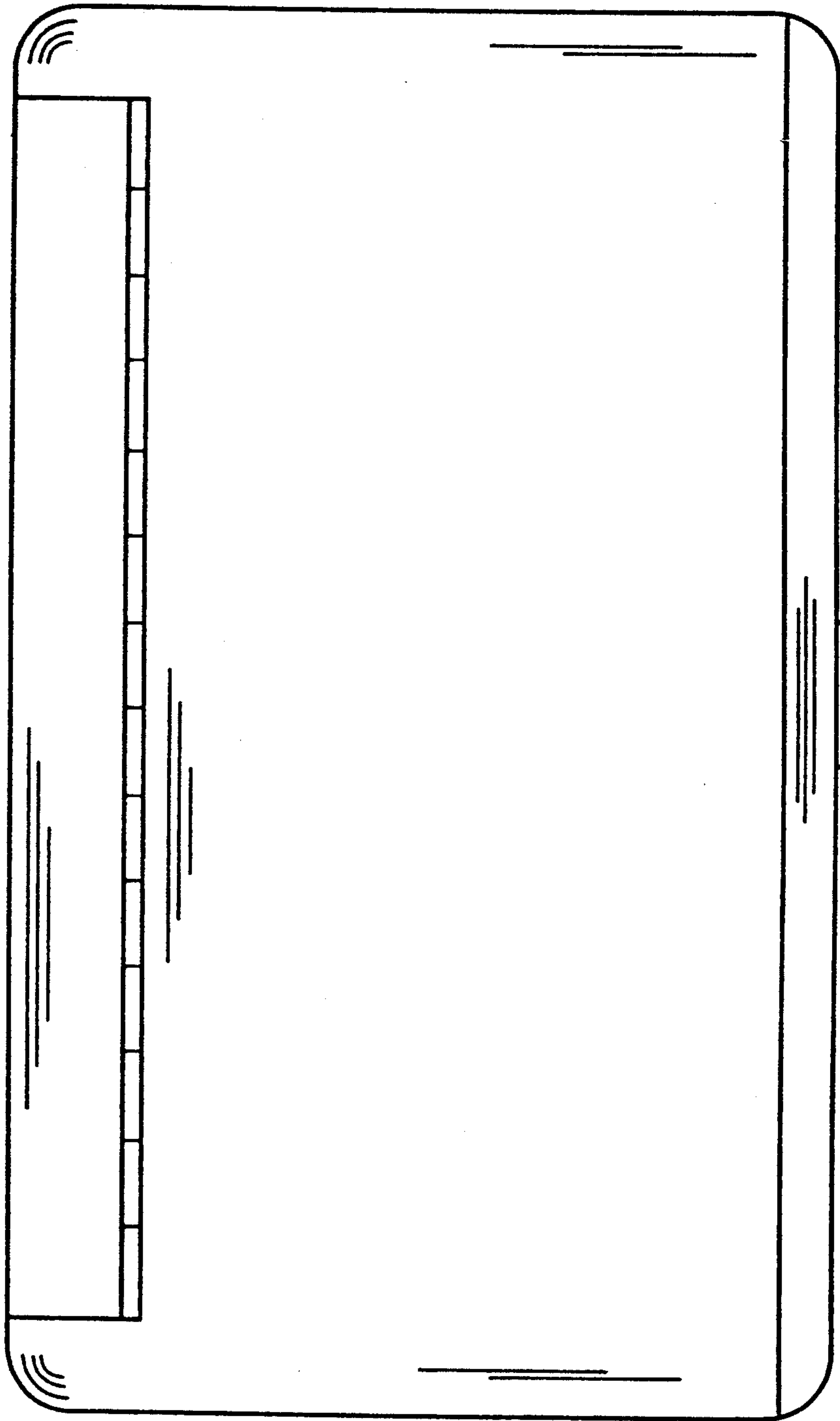

FIG. 6