



US00D344365S

United States Patent [19]

[11] Patent Number: **Des. 344,365**

Mondo

[45] Date of Patent: **** Feb. 15, 1994**

[54] COMBINED RAZOR AND SHAVING CREAM DISPENSER

[76] Inventor: **Luciano G. Mondo**, 68 Duer St., N. Plainfield, N.J. 07060

[**] Term: **14 Years**

[21] Appl. No.: **665,168**

[22] Filed: **Mar. 6, 1991**

[52] U.S. Cl. **D28/46**

[58] Field of Search 30/32, 34.05, 34.1, 30/34.2, 41, 41.5, 47-49, 85, 86, 90; D28/44-48

[56] References Cited

U.S. PATENT DOCUMENTS

D. 38,754	8/1907	Arnold	D28/46
1,924,641	8/1933	Dupeyron	30/47
2,669,017	2/1954	Seko	30/86 X
4,314,404	2/1982	Ruiz	30/41
4,339,876	7/1982	Davis	30/90
4,635,361	1/1987	DeMars	30/41
4,813,138	3/1989	Chen	30/41

FOREIGN PATENT DOCUMENTS

1315148	12/1963	France	30/46.7
416509	11/1946	Italy	30/47

Primary Examiner—Bernard Ansher
Assistant Examiner—C. Tuttle
Attorney, Agent, or Firm—Terry M. Gernstein

[57] CLAIM

The ornamental design for a combined razor and shaving cream dispenser, as shown and described.

DESCRIPTION

FIG. 1 is a perspective view of the combined razor and shaving cream dispenser embodying the design of the present invention;

FIG. 2 is a front elevational view thereof;

FIG. 3 is a rear elevational view thereof;

FIG. 4 is a side elevational view thereof;

FIG. 5 is a side elevational view thereof;

FIG. 6 is a top plan view thereof;

FIG. 7 is a bottom view thereof; and,

FIG. 8 is a fragmentary bottom perspective view thereof.

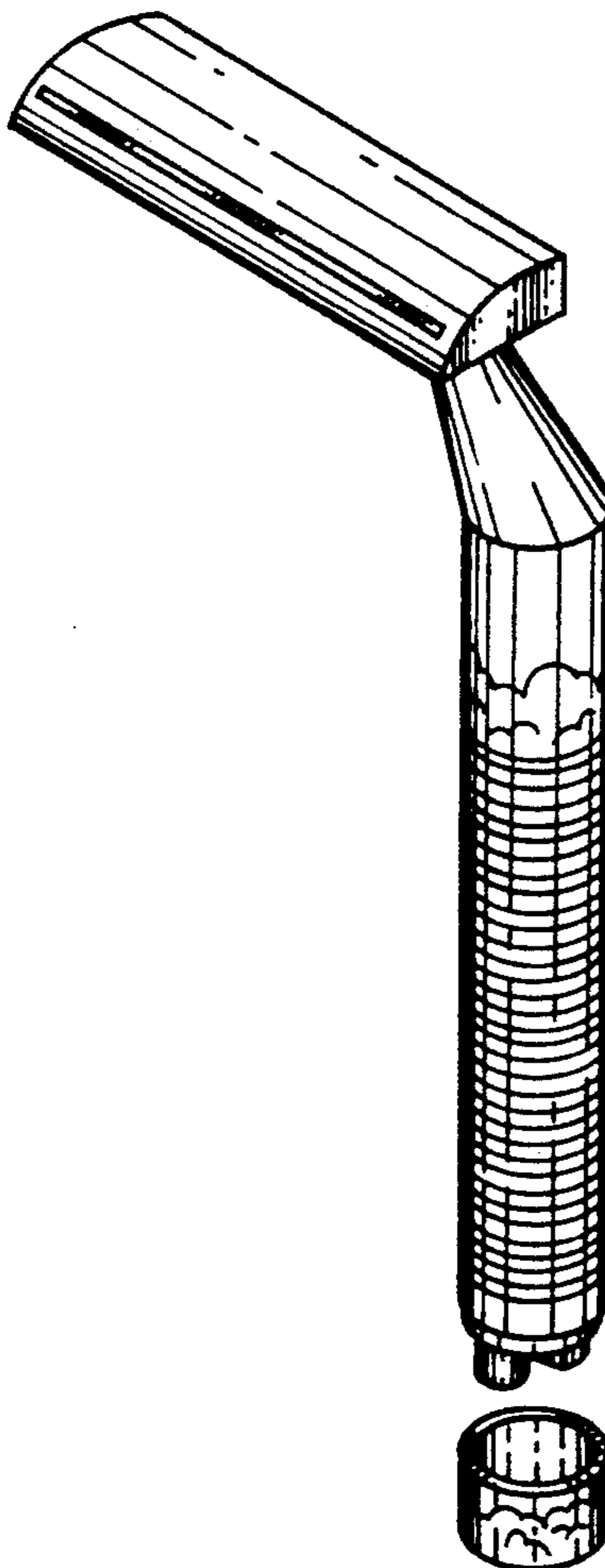

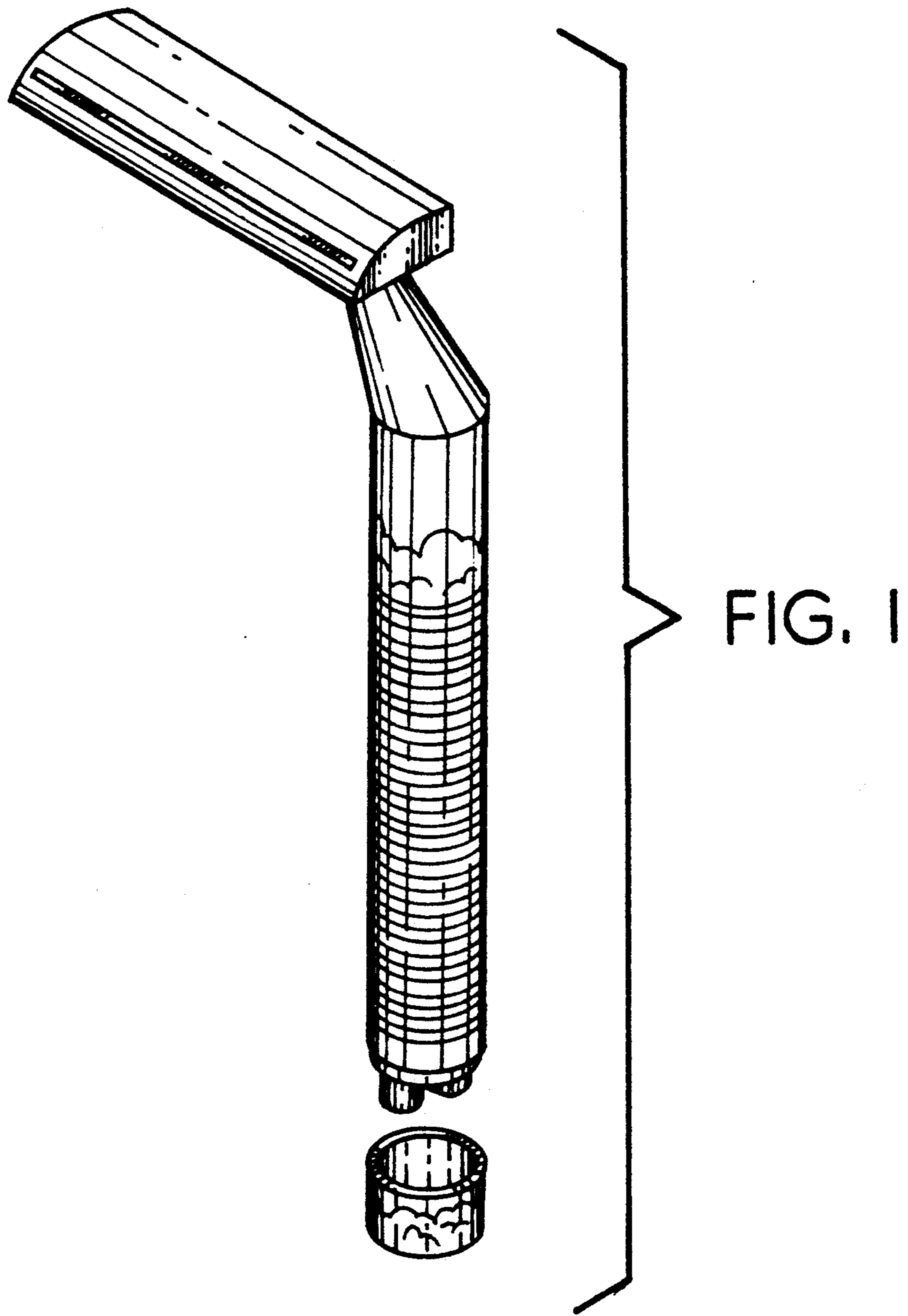

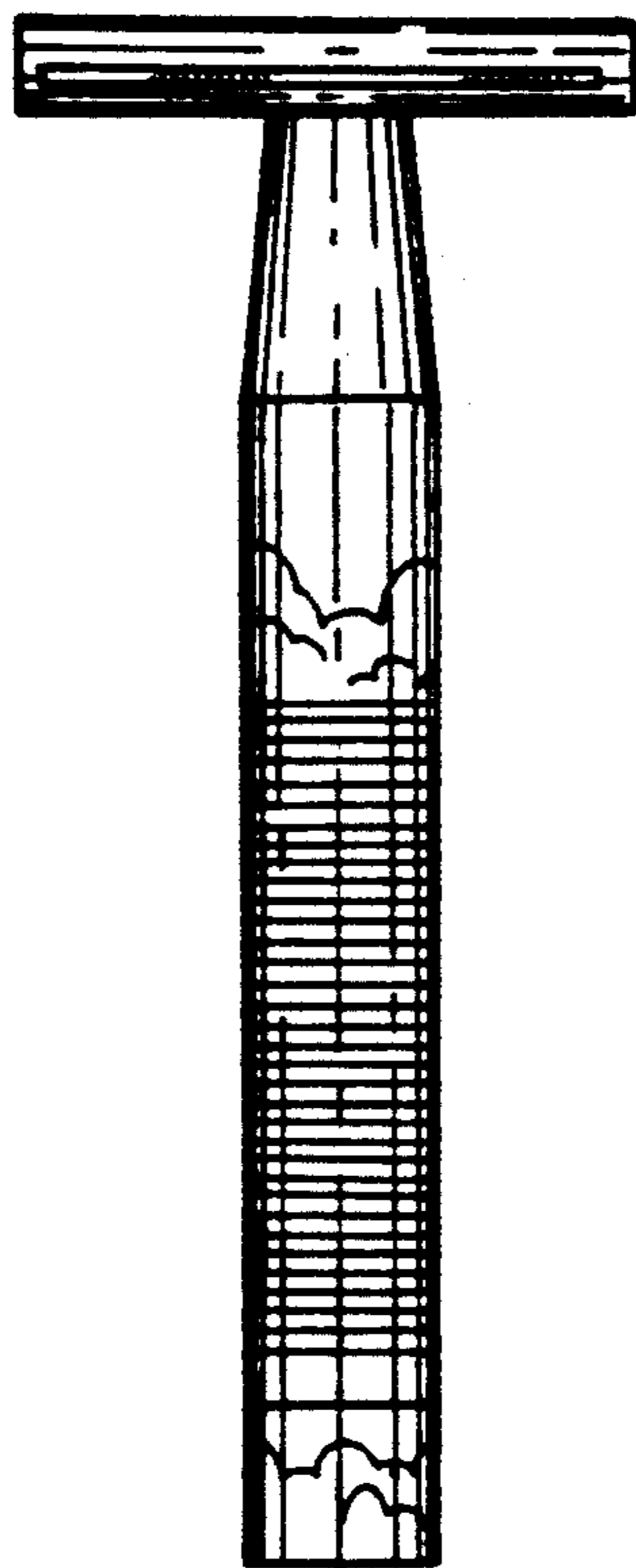

FIG. 2

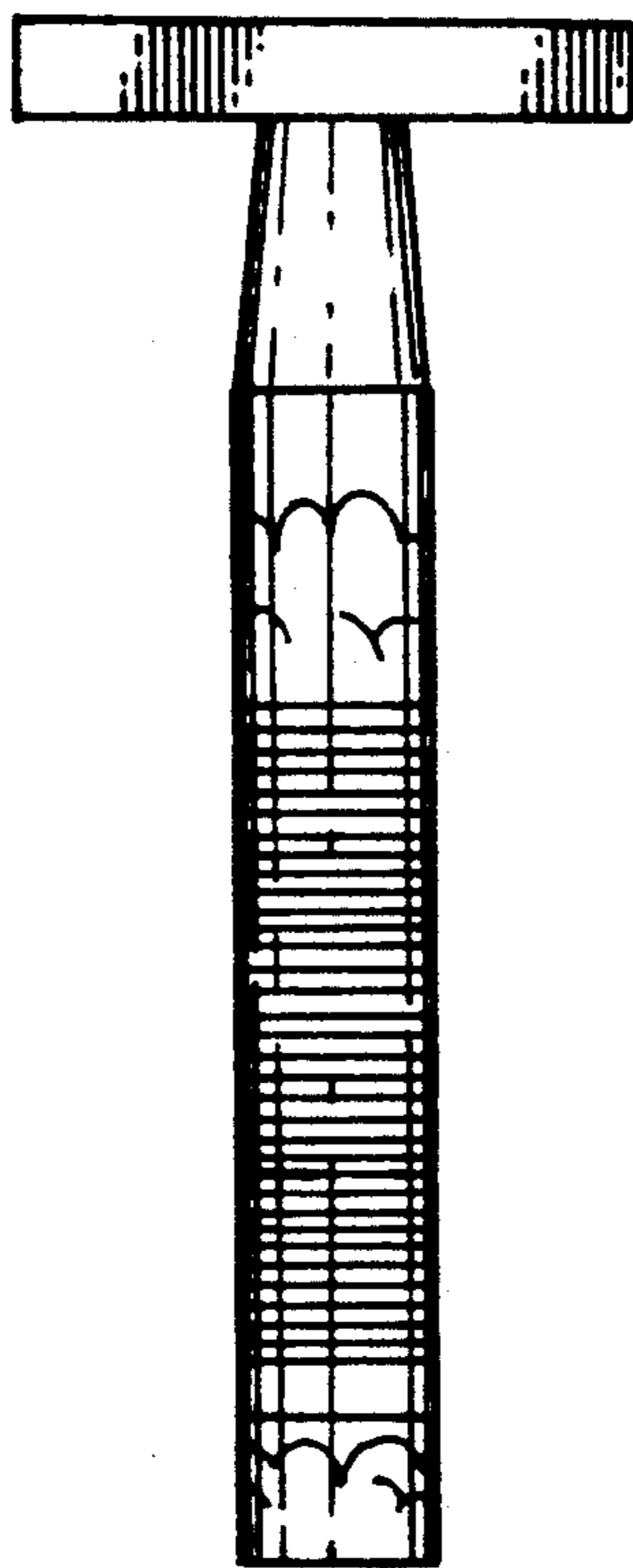

FIG. 3

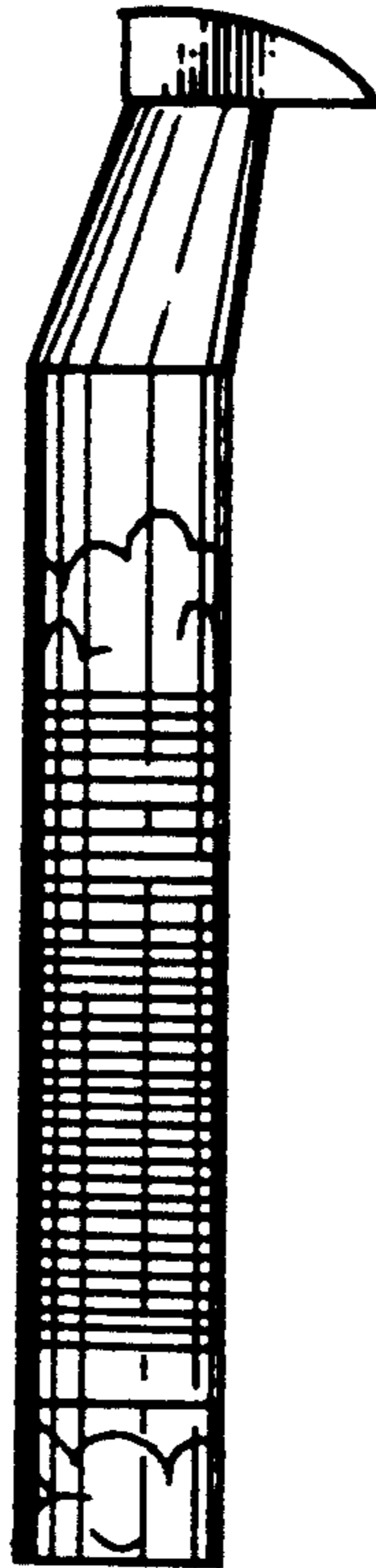

FIG. 4

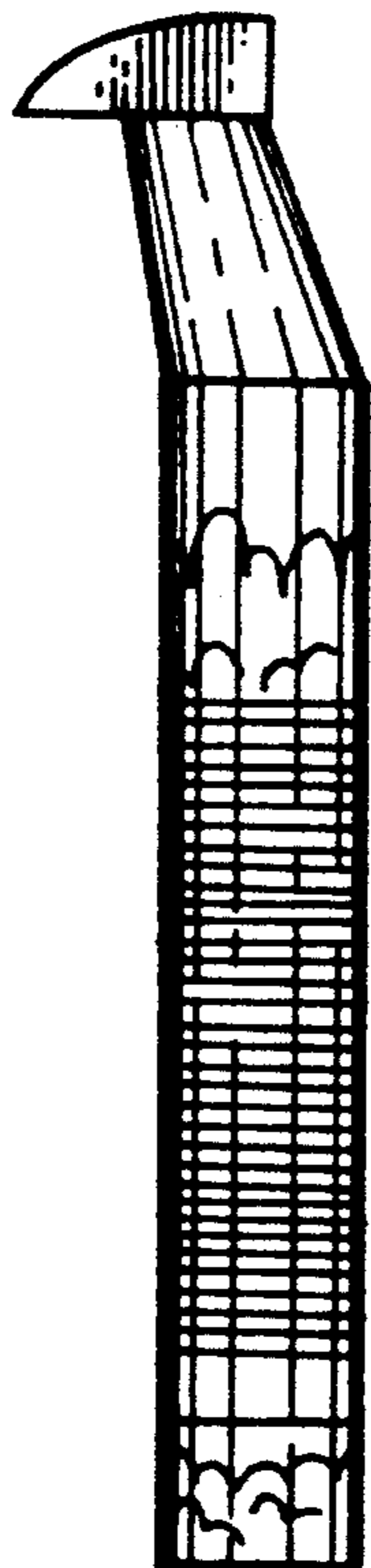

FIG. 5



FIG. 6

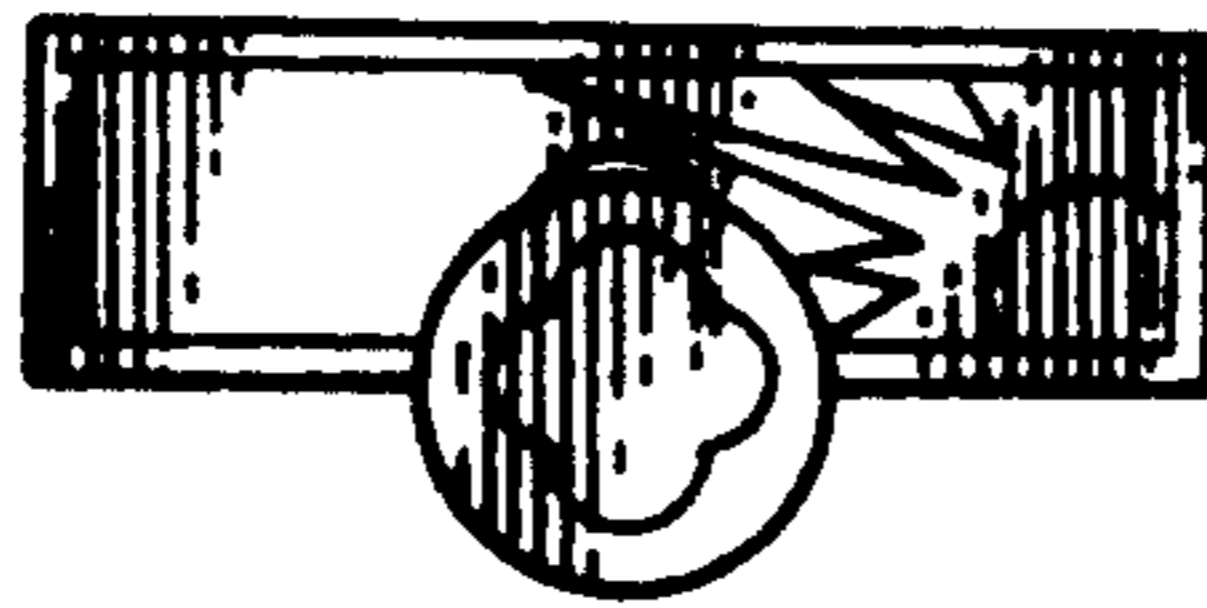

FIG. 7

