



US00D344348S

United States Patent [19]

[11] Patent Number: **Des. 344,348**

Lo

[45] Date of Patent: **** Feb. 15, 1994**

[54] **CAMPING LANTERN**

D. 300,871 4/1989 Yuen D26/41

[76] Inventor: **Kai-Bun Lo**, Room 1117, Peninsula Centre, 67 Mody Road, Tsimshatsui East, Kowloon, Hong Kong

FOREIGN PATENT DOCUMENTS

1805366 5/1970 Fed. Rep. of Germany 362/199
1104841 2/1968 United Kingdom 362/190

[**] Term: **14 Years**

Primary Examiner—Susan J. Lucas

[21] Appl. No.: **877,600**

Attorney, Agent, or Firm—Samuels, Gauthier & Stevens

[22] Filed: **May 1, 1992**

[57] CLAIM

[30] Foreign Application Priority Data

The ornamental design for a camping lantern, as shown and described.

Nov. 4, 1991 [GB] United Kingdom 2018743

DESCRIPTION

[52] U.S. Cl. **D26/41**

FIG. 1 is the front elevational view showing my new design;

[58] Field of Search 362/157, 158, 183-202;
D26/37-50

FIG. 2 is the rear elevational view thereof;

[56] References Cited

U.S. PATENT DOCUMENTS

D. 285,354 8/1986 Yuen D26/41

FIG. 3 is the left side view thereof;

FIG. 4 is the right side view thereof;

FIG. 5 is the top plan view thereof; and,

FIG. 6 is the bottom plan view thereof.

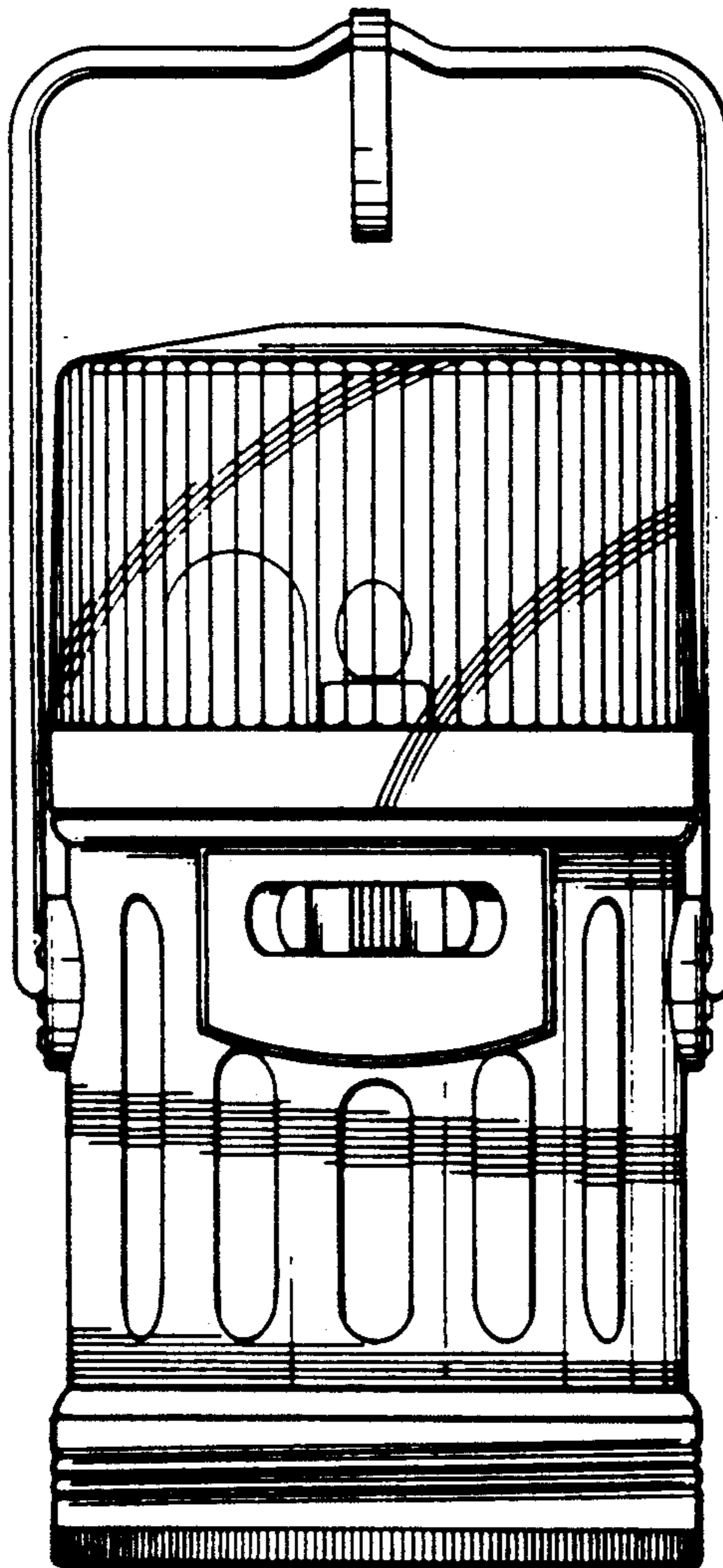

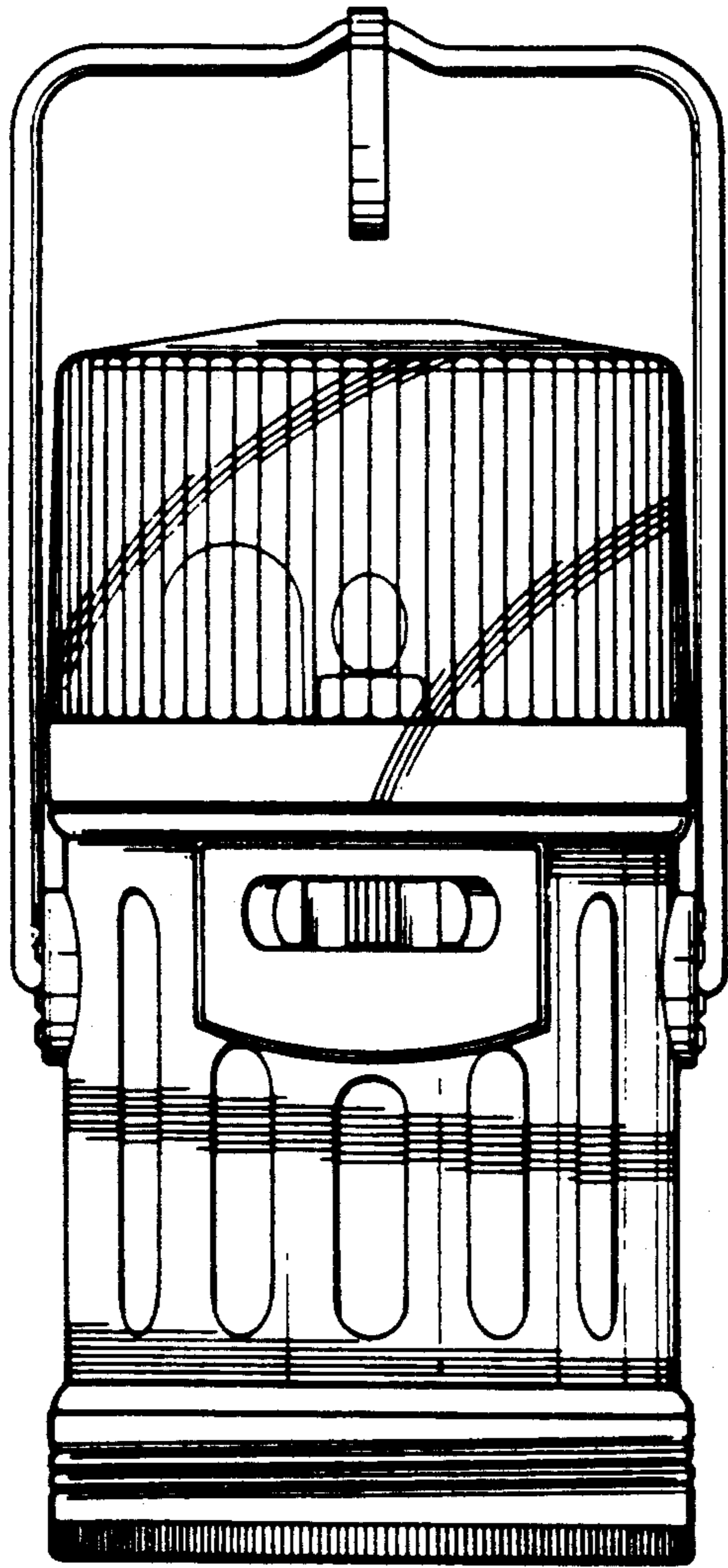

FIG. 1

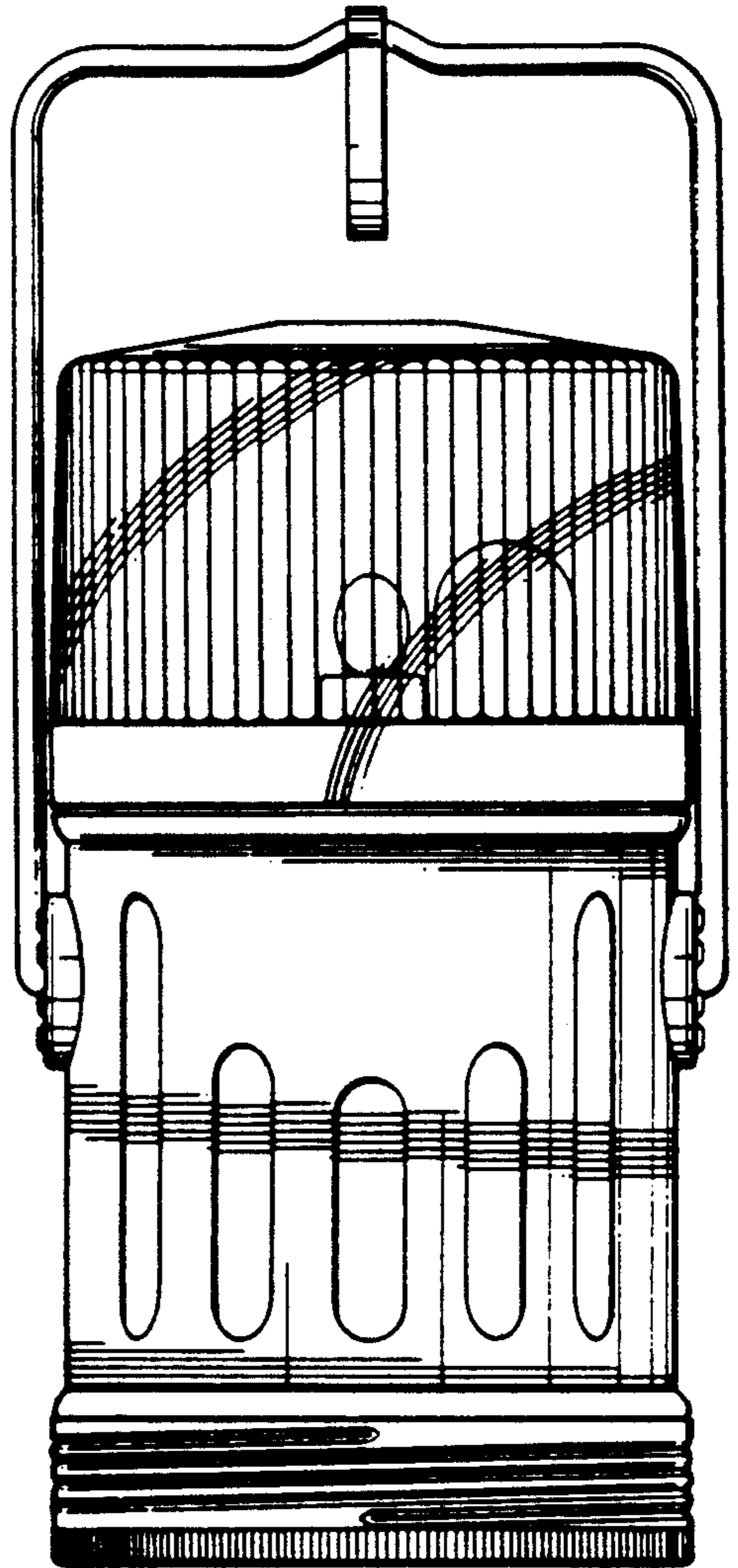

FIG. 2

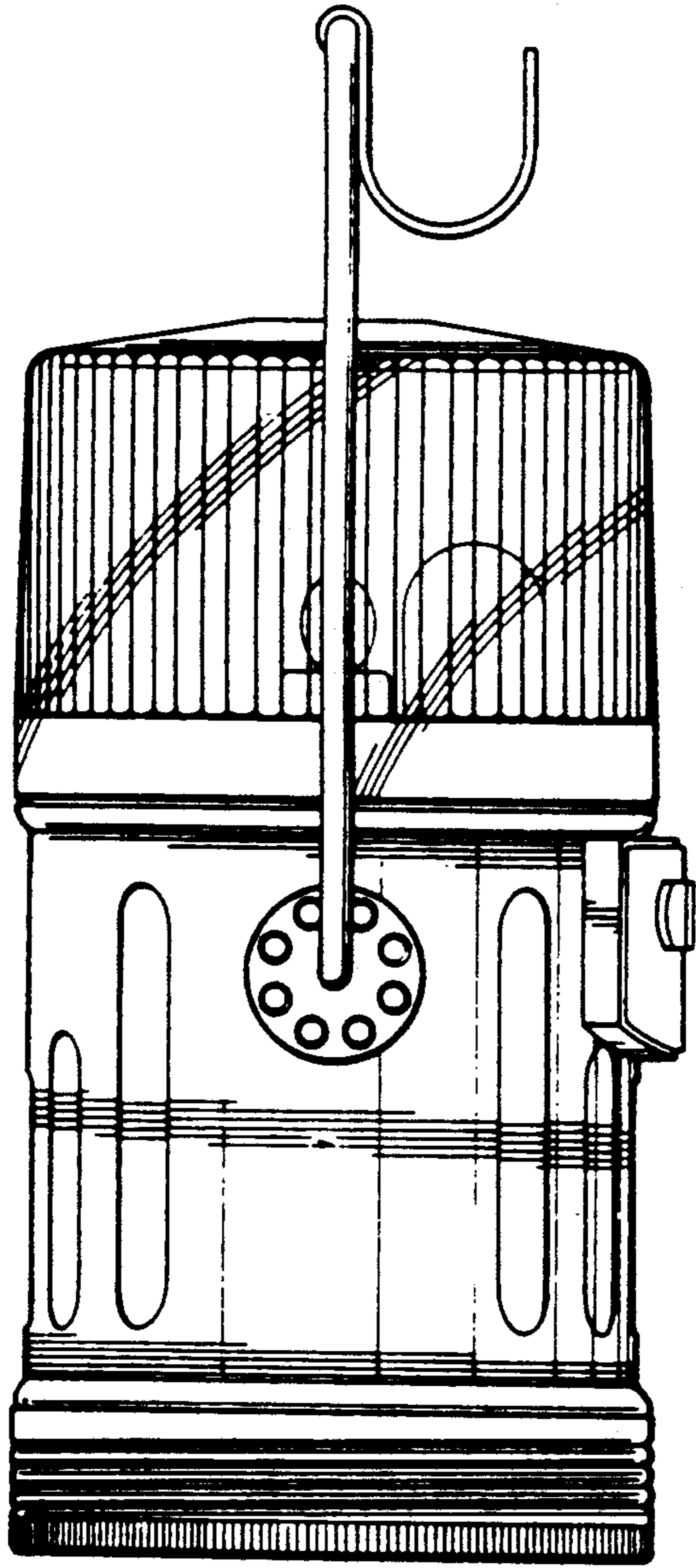

FIG. 3

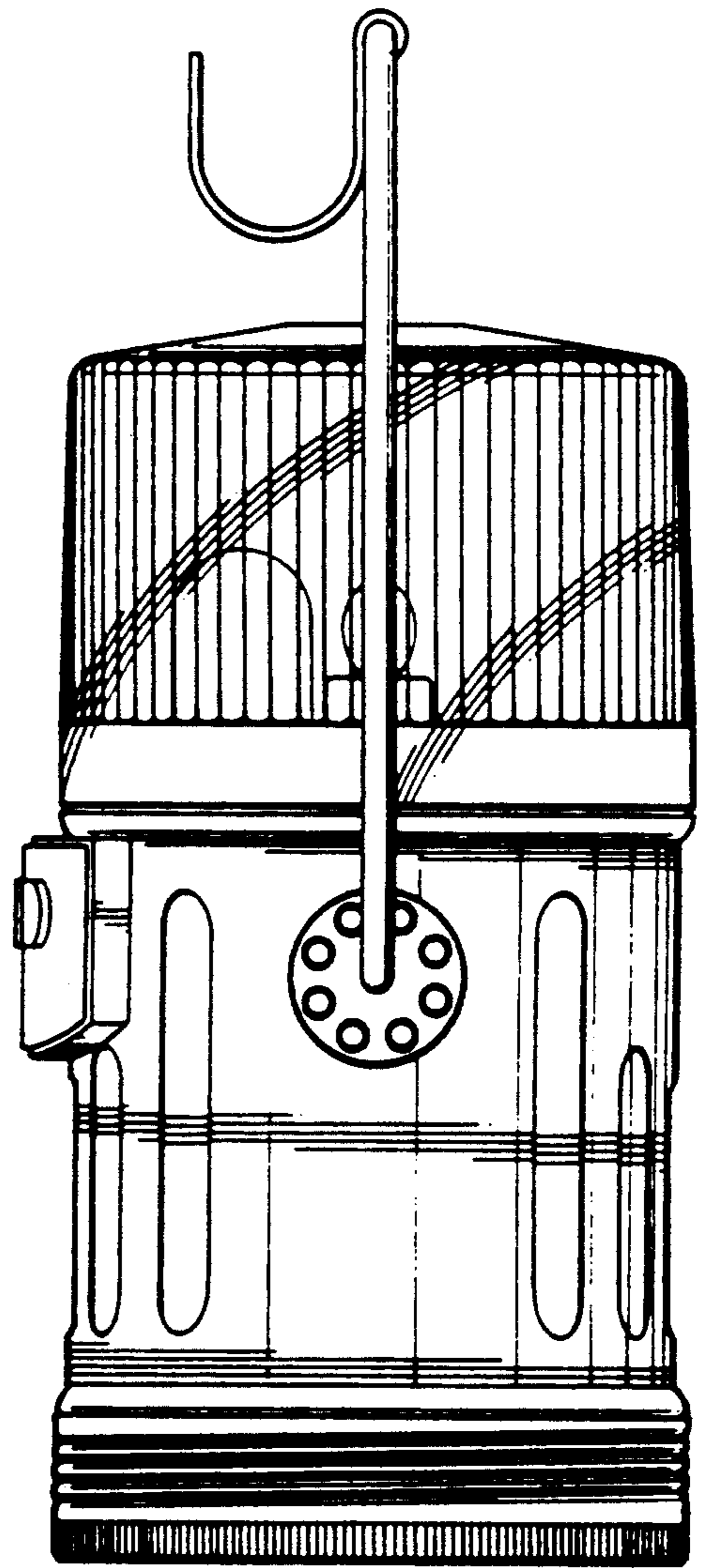

FIG. 4

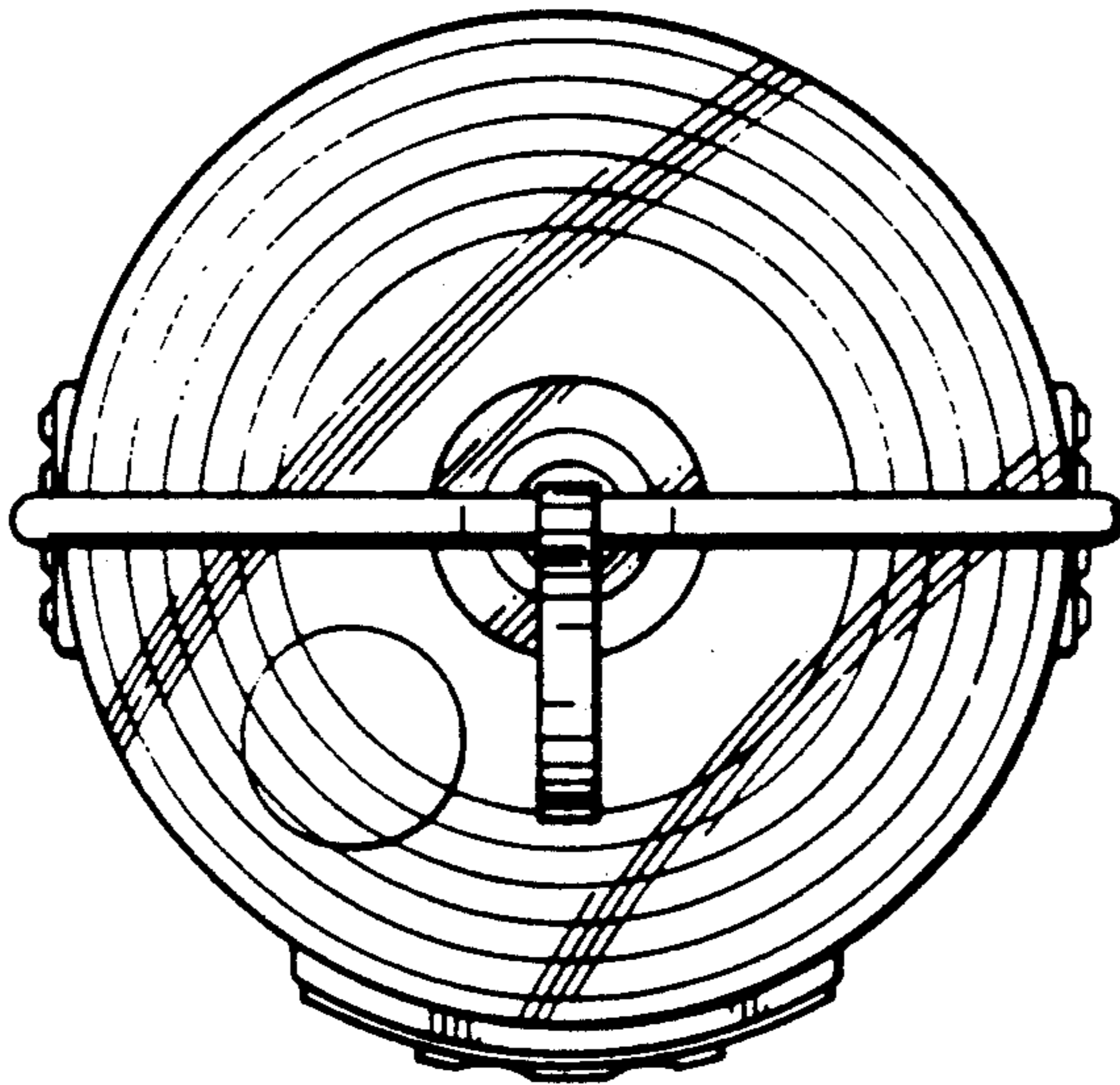

FIG. 5

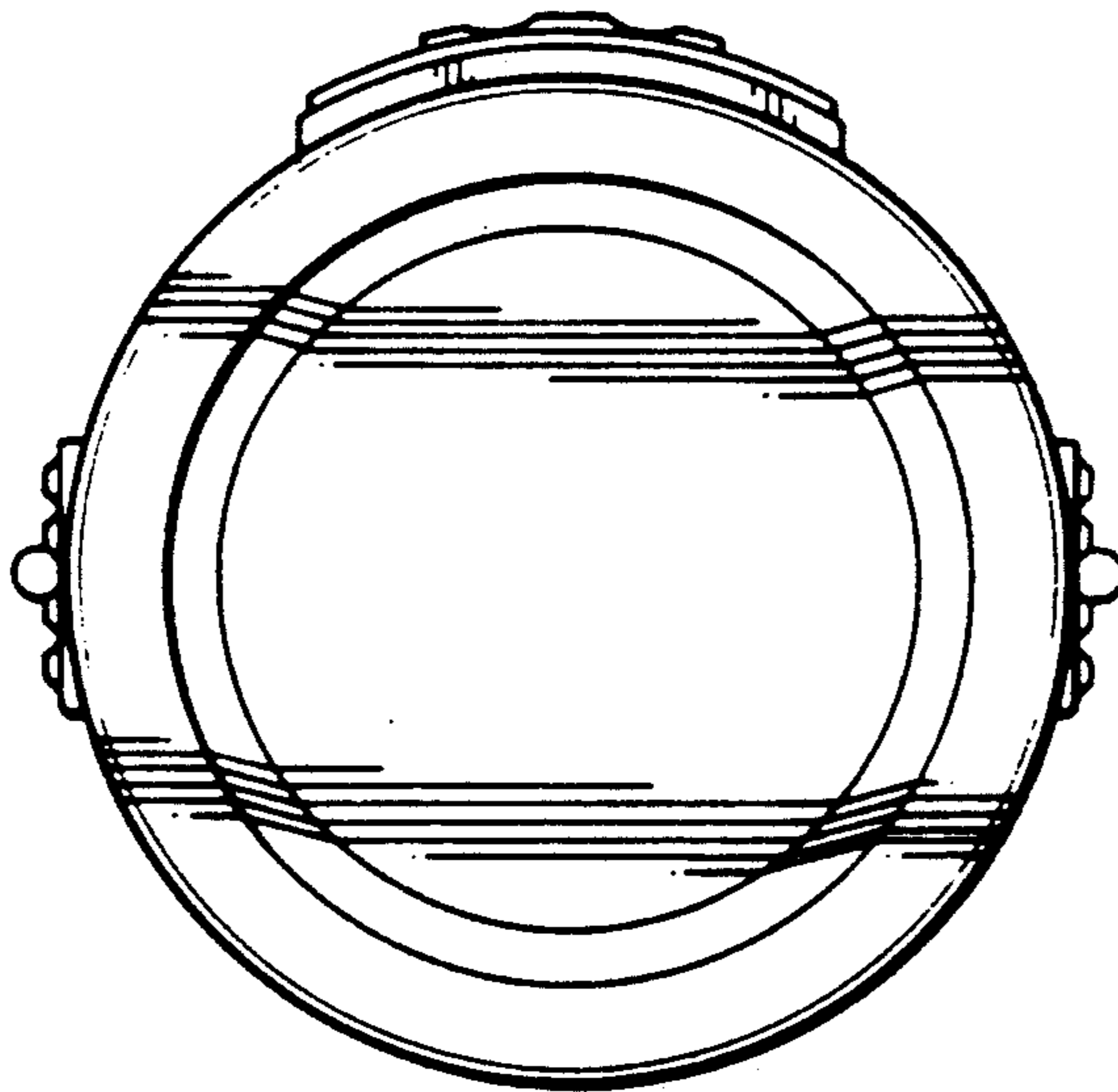

FIG. 6