



US00D344287S

# United States Patent [19]

[11] Patent Number: **Des. 344,287**

**Johnson**

[45] Date of Patent: **\*\* Feb. 15, 1994**

[54] **COMBINED PEN, CHAIN AND WALL-MOUNTABLE BRACKET THEREFOR**

[75] Inventor: **David B. Johnson**, Rickmansworth, England

[73] Assignee: **CDS & Co. Manufacturing Limited**, England

[\*\*] Term: **14 Years**

[21] Appl. No.: **817,256**

[22] Filed: **Jan. 3, 1992**

[30] **Foreign Application Priority Data**

Jul. 3, 1991 [GB] United Kingdom ..... 2015743

[52] U.S. Cl. .... **D19/36; D19/44; D19/56**

[58] Field of Search ..... 401/52, 195; **D19/35, D19/36, 41-51, 54-58, 81-85, 99, 100**

[56] **References Cited**

**U.S. PATENT DOCUMENTS**

D. 185,331 5/1959 Tannenbaum ..... D19/44 X

D. 202,674 10/1965 Dales ..... D19/44 X

D. 202,843 11/1965 Dales ..... D19/44 X

D. 254,856 4/1980 Bajusz ..... D19/44

D. 281,174 10/1985 Mahoney et al. .... D19/84 X

D. 299,659 1/1989 Lantz ..... D19/44 X

D. 330,320 10/1992 Lapsker ..... D8/104

**OTHER PUBLICATIONS**

Guernsey Office Products, 1989, see p. 570, mountable pen lower right corner Desk copy.

*Primary Examiner*—Nelson C. Holtje  
*Assistant Examiner*—Martie Thompson  
*Attorney, Agent, or Firm*—Koch, Robert J.

[57] **CLAIM**

The ornamental design for a combined pen, chain and wall-mountable bracket therefor, as shown and described.

**DESCRIPTION**

FIG. 1 is a perspective view of a combined pen, chain and wall-mountable bracket therefor showing my new design with the pen shown separated;

FIG. 2 is a perspective view with the pen in a stored position;

FIG. 3 is a top plan view;

FIG. 4 is a bottom plan view;

FIG. 5 is a front elevational view with the bracket removed for convenience of illustration;

FIG. 6 is a front elevational view of FIG. 5 with the pen shown separated;

FIG. 7 is a side elevational view of FIG. 6;

FIG. 8 is a rear elevational view of FIG. 2;

FIG. 9 is a side elevational view of FIG. 1;

FIG. 10 is a front perspective view of FIG. 5;

FIG. 11 is a front perspective view of FIG. 6; and,

FIG. 12 is a perspective view of FIG. 1 in an exploded condition.

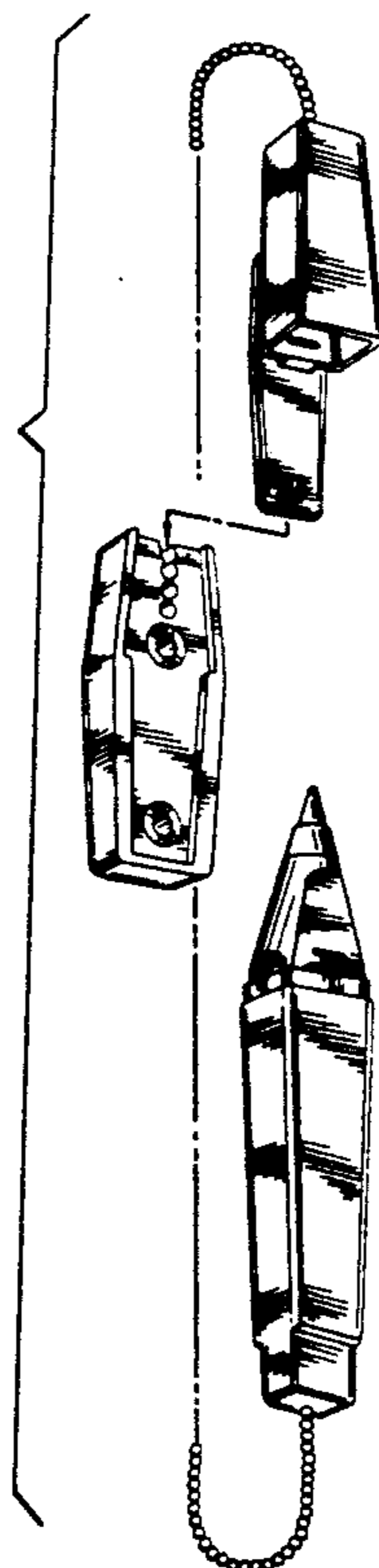

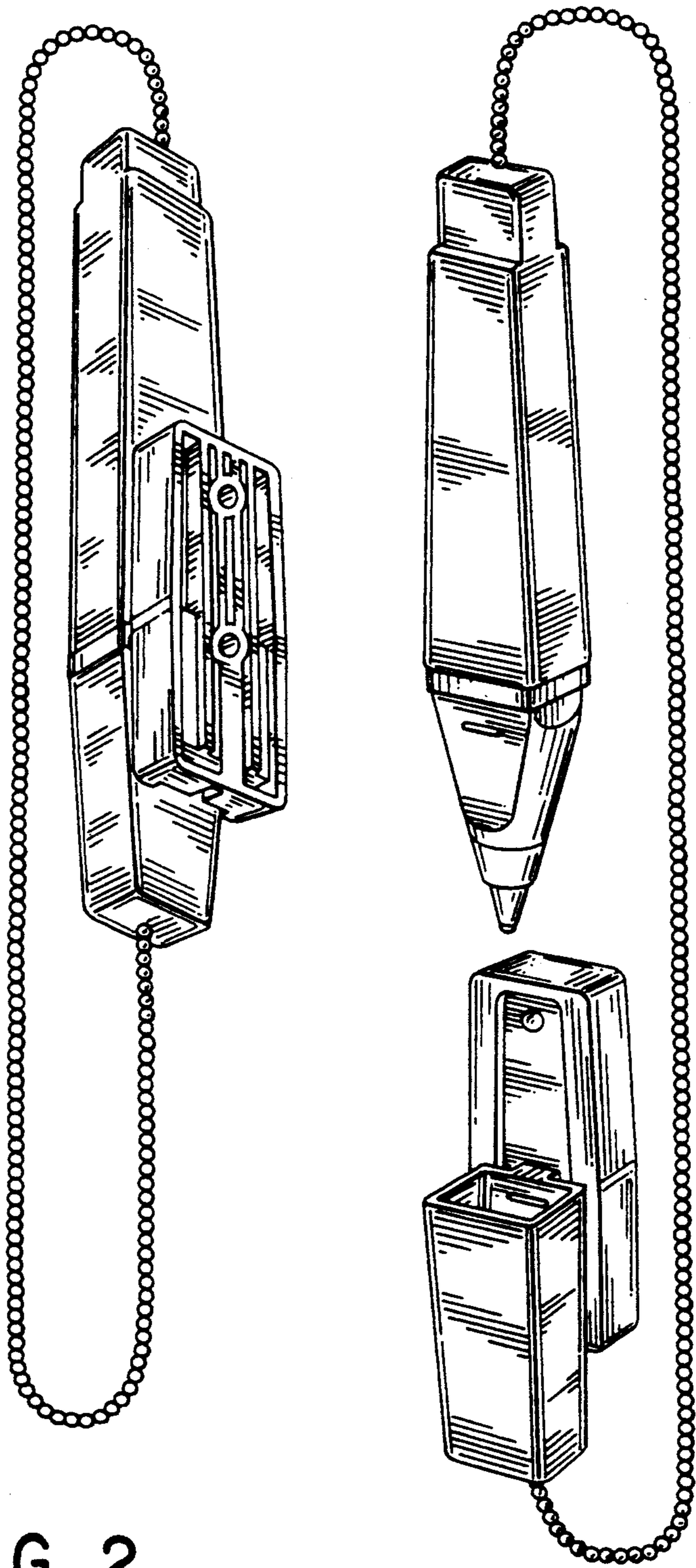

FIG. 2

FIG. 1

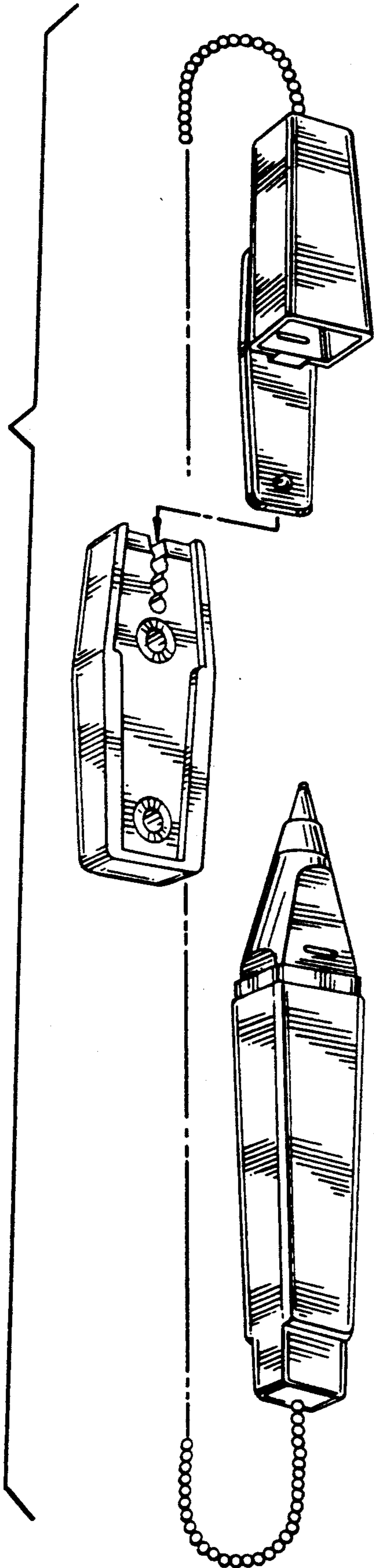

FIG. 3

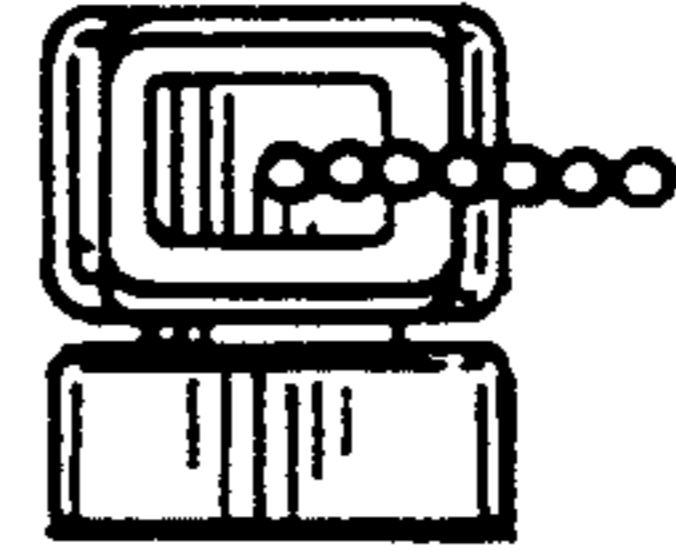

FIG. 12

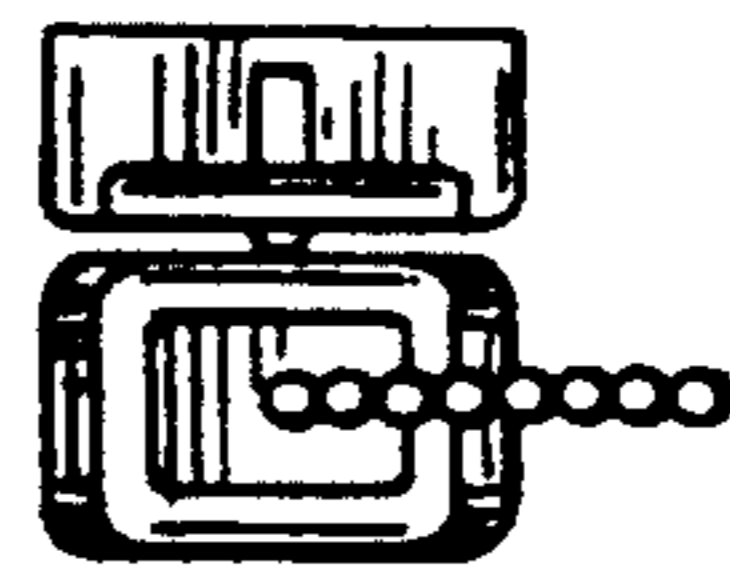

FIG. 4

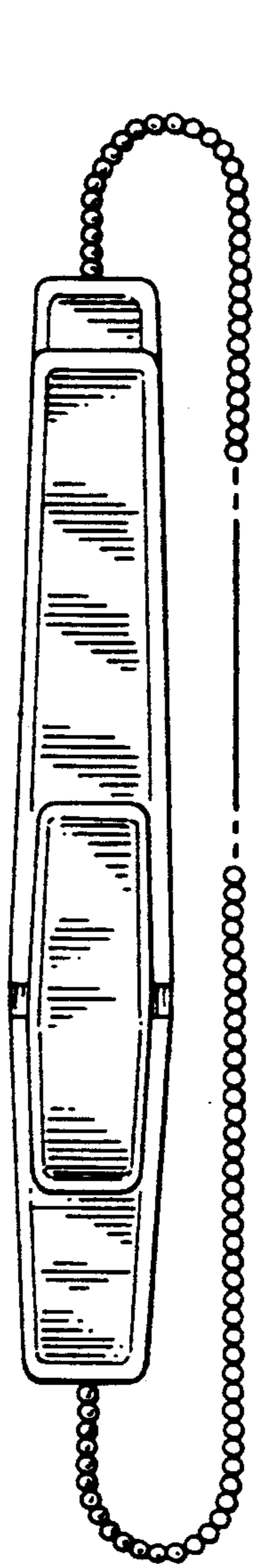

FIG. 5

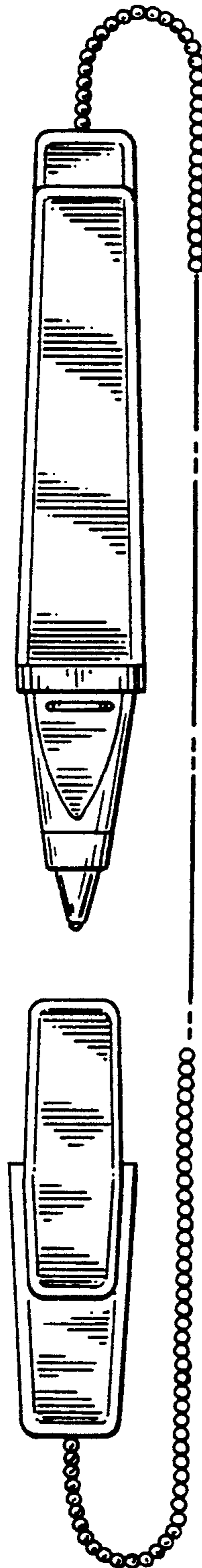

FIG. 6

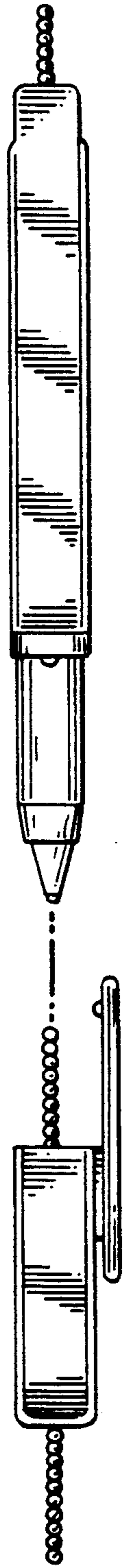

FIG. 7

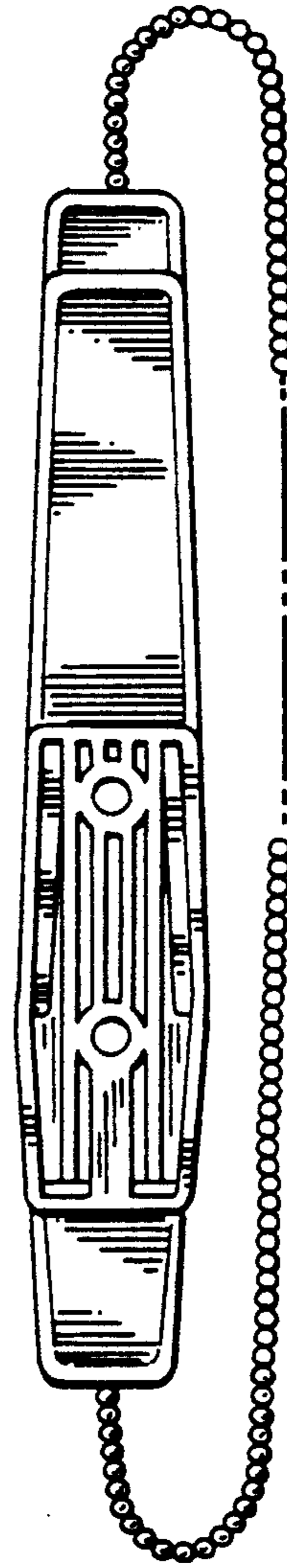

FIG. 8

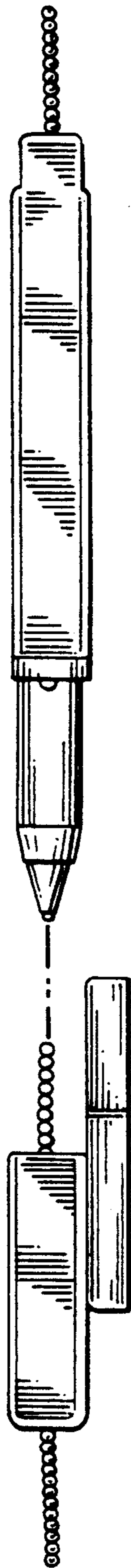

FIG. 9

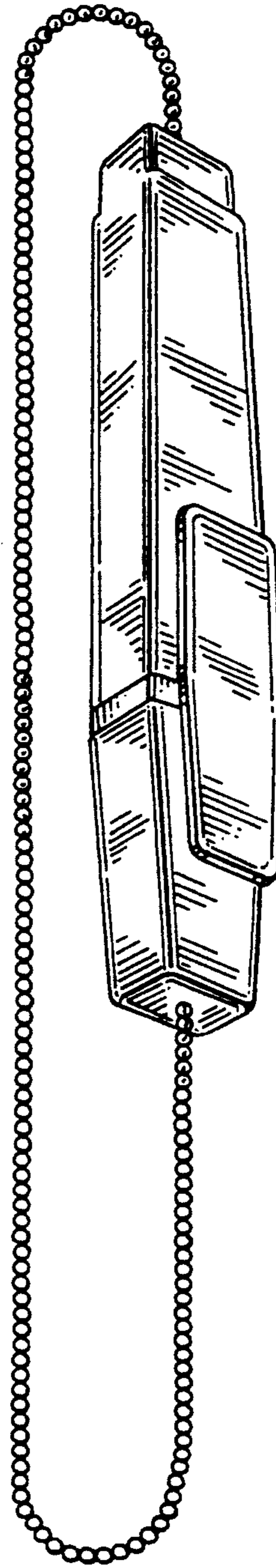

FIG. 10

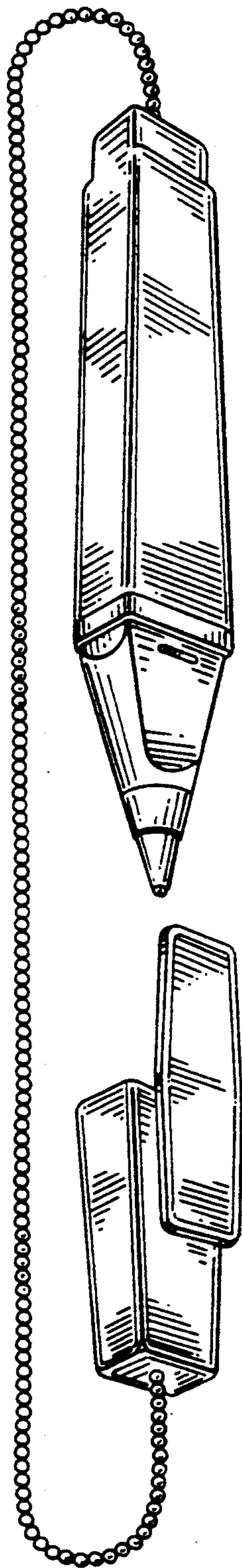

FIG. 11