



US00D344255S

United States Patent [19]

[11] Patent Number: Des. 344,255

Opitz

[45] Date of Patent: ** Feb. 15, 1994

[54] **MOTORCYCLE BELT GUARD COVER**

[75] Inventor: Douglas G. Opitz, West Bend, Wis.

[73] Assignee: Harley-Davidson, Inc., Milwaukee, Wis.

[**] Term: 14 Years

[21] Appl. No.: 1,520

[22] Filed: Nov. 16, 1992

[52] U.S. Cl. D12/126

[58] Field of Search 280/288.4; D12/126, D12/114

[56] **References Cited**

U.S. PATENT DOCUMENTS

D. 294,131 2/1988 Stahel D12/126

OTHER PUBLICATIONS

Drag Specialties Catalog, 1987, pp. 271 & 494 the chrome shifter guides, the mousetrap cover & wing-leader timing belt covers.

Harley-Davidson 1992 Accessories Catalog, pp. 14, 39

Sportster Chrome Belt Guard 6404-91 Chrome Lower Belt Guard 60366-89A, 60394-90.

Harley-Davidson 1987 Accessories Catalog, pp. 3, 8

Chrome Belt Guards 91774-85 91739-87 Chrome Belt/-Chain Guards 60380-79, 60302-73.

Primary Examiner—Wallace R. Burke

Assistant Examiner—M. N. Brown

Attorney, Agent, or Firm—Michael, Best & Friedrich

[57] **CLAIM**

The ornamental design for a motorcycle belt guard cover, as shown and described.

DESCRIPTION

FIG. 1 is a perspective view of a motorcycle belt guard cover showing my new design;

FIG. 2 is a front view thereof;

FIG. 3 is a right side view thereof;

FIG. 4 is a left side view thereof;

FIG. 5 is a top view thereof;

FIG. 6 is a bottom view thereof;

FIG. 7 is a rear view thereof;

FIG. 8 is a perspective view of a motorcycle belt guard cover showing a second embodiment of my new design.

FIG. 9 is a front view of the embodiment of FIG. 8;

FIG. 10 is a right side view of the embodiment of FIG. 8;

FIG. 11 is a left side view of the embodiment of FIG. 8;

FIG. 12 is a top view of the embodiment of FIG. 8;

FIG. 13 is a bottom view of the embodiment of FIG. 8; and,

FIG. 14 is a rear view of the embodiment of FIG. 8.

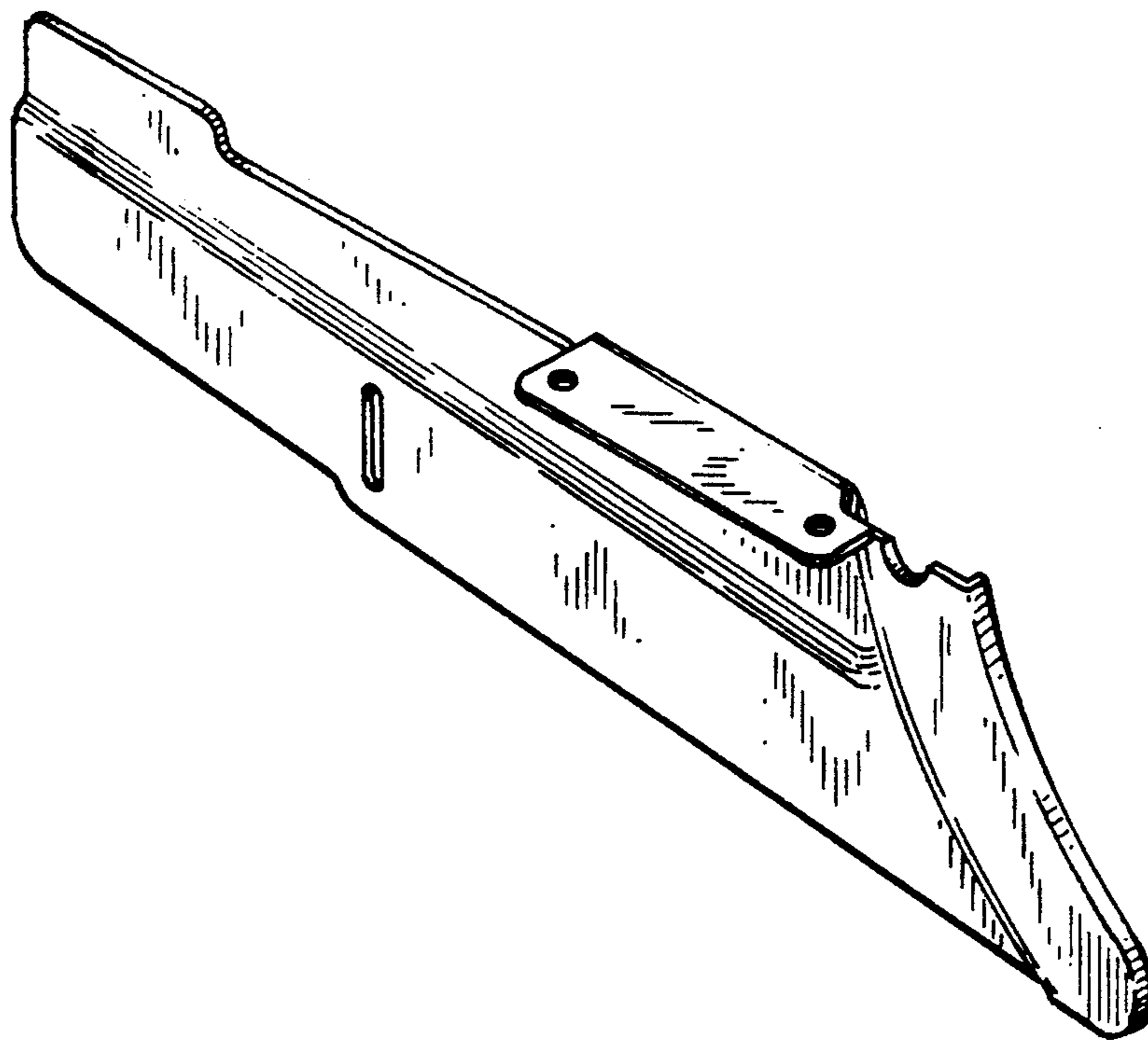

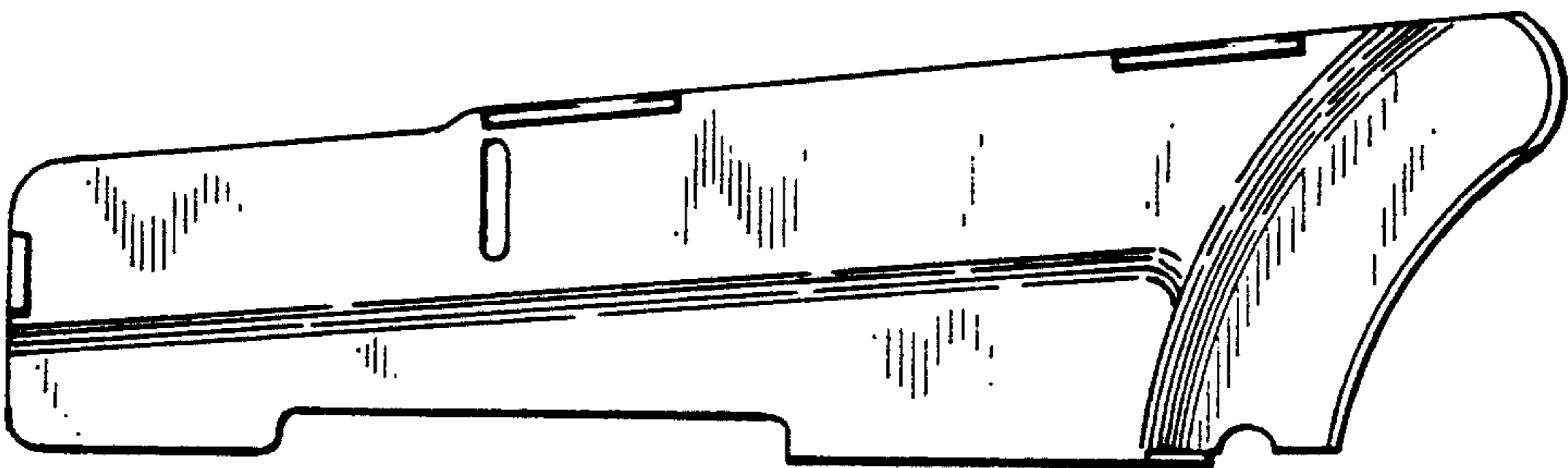
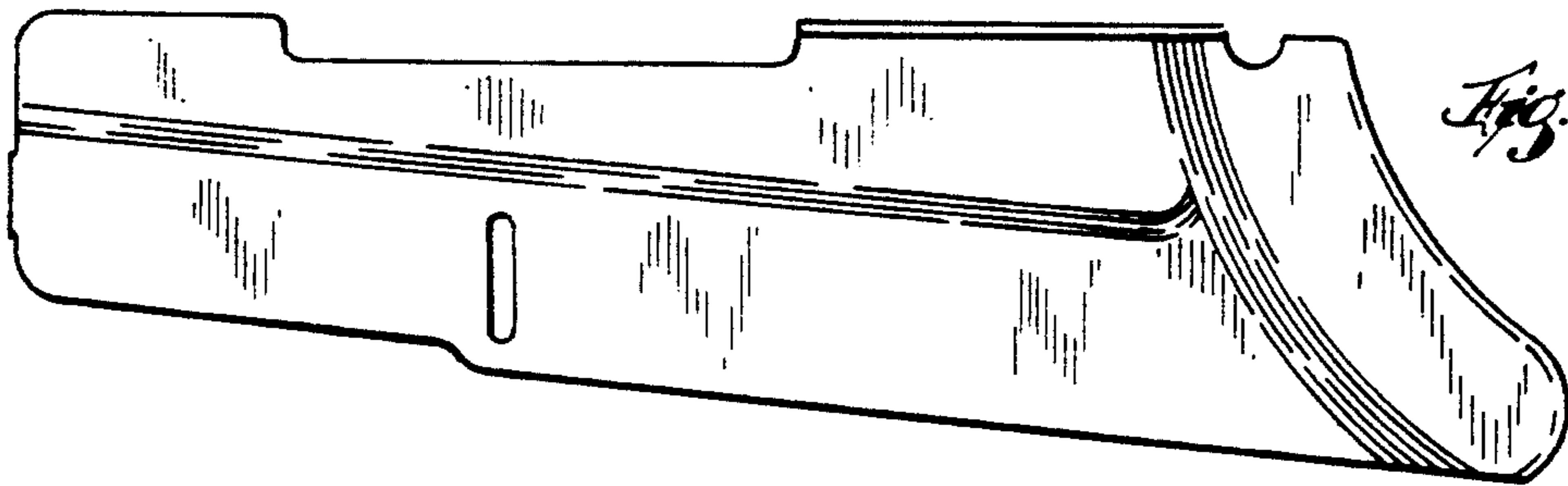
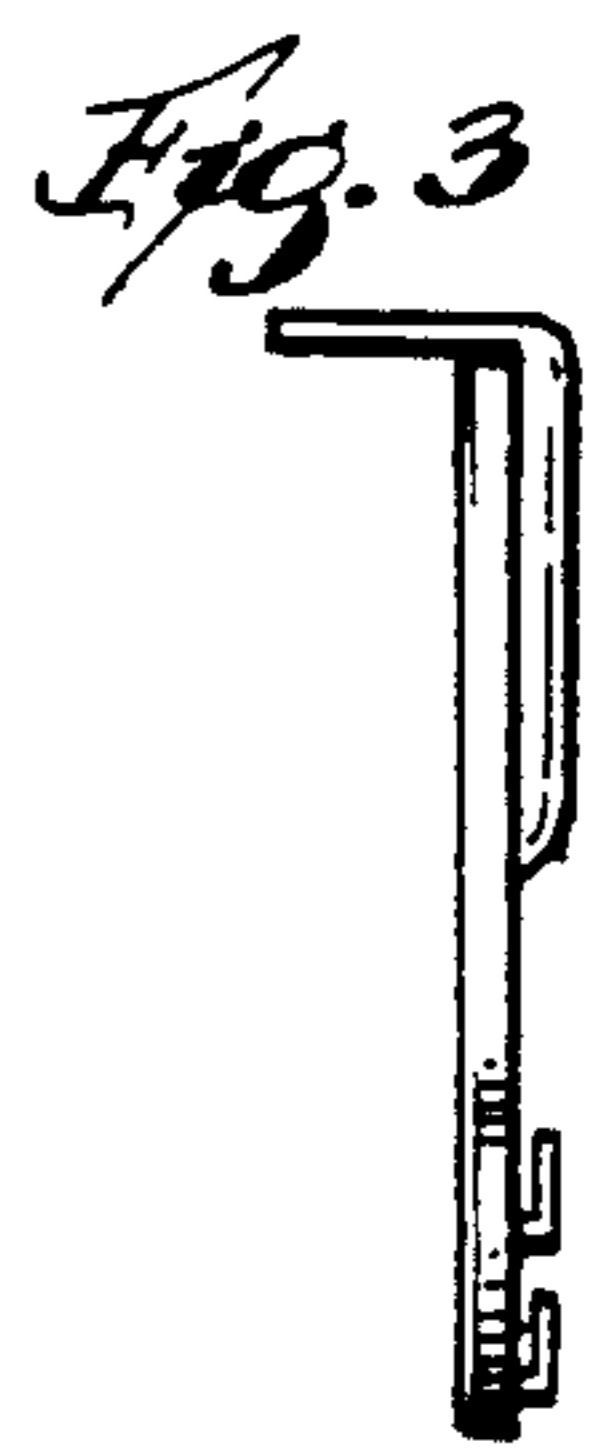
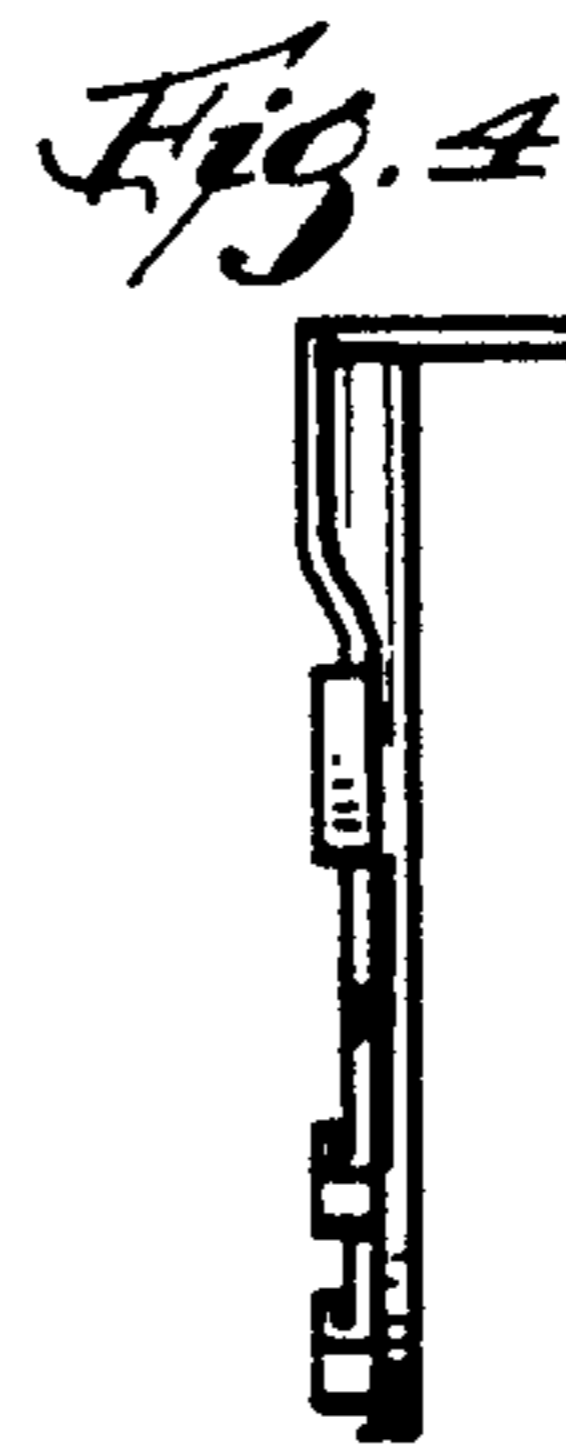
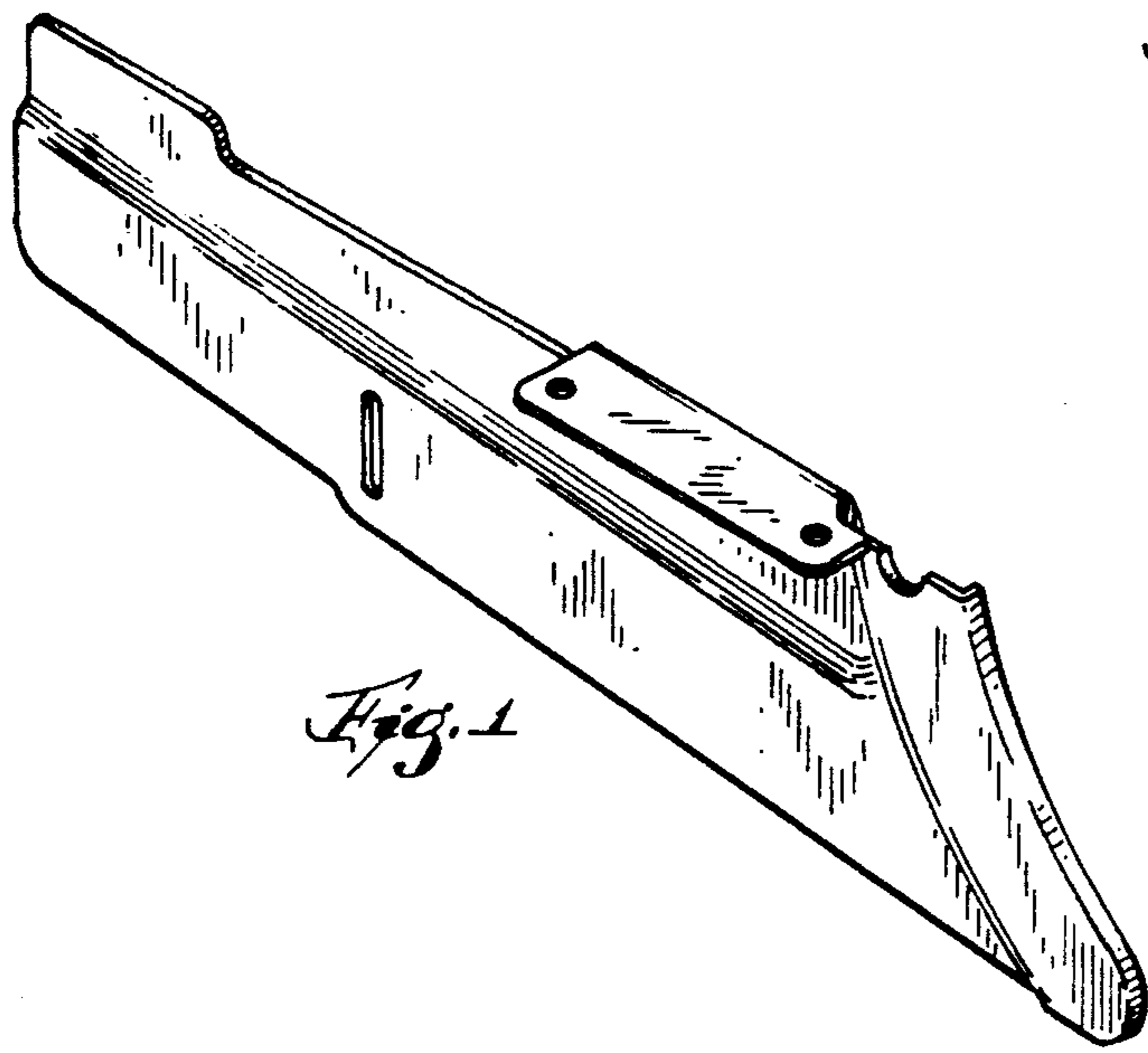

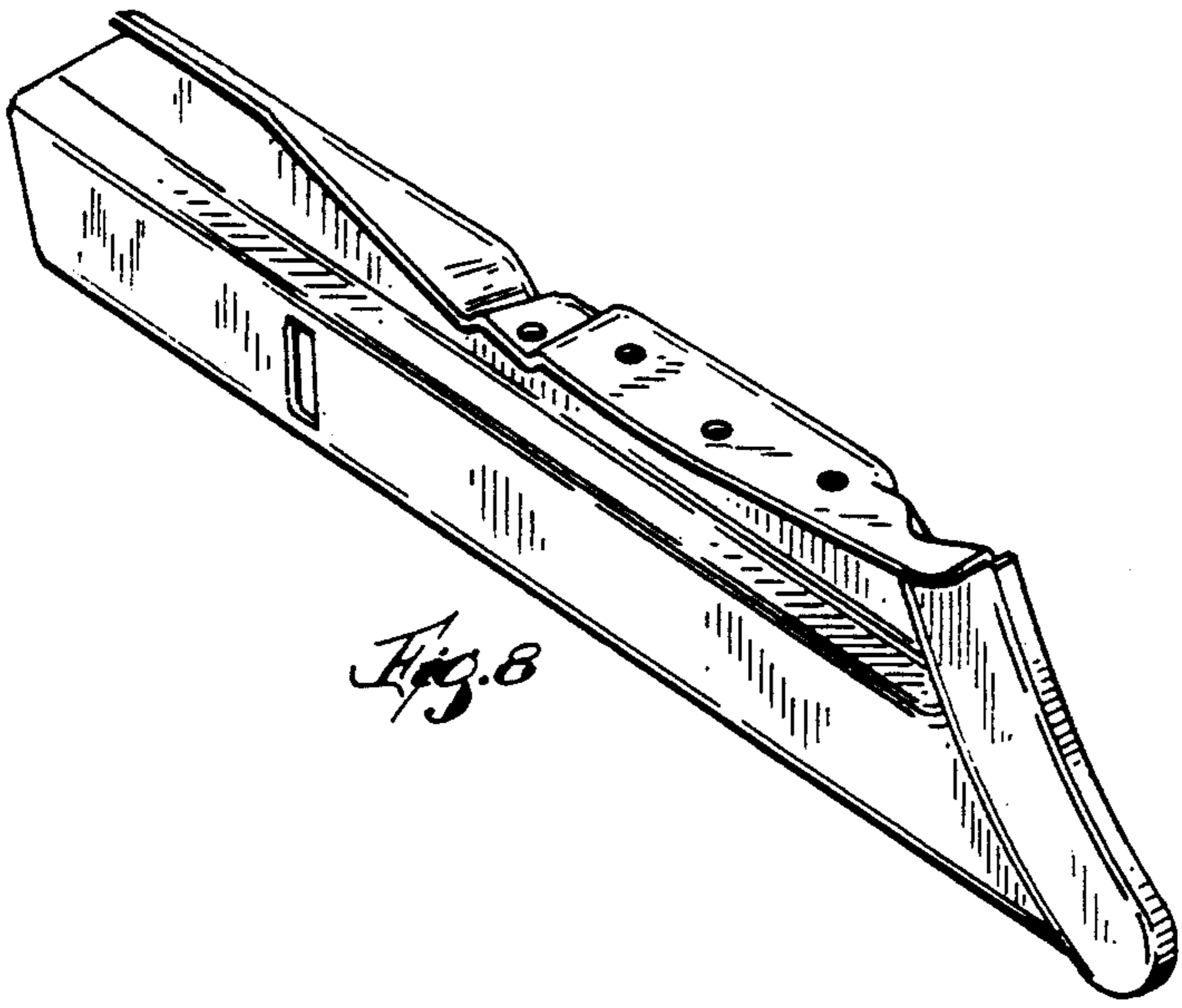

Fig. 8

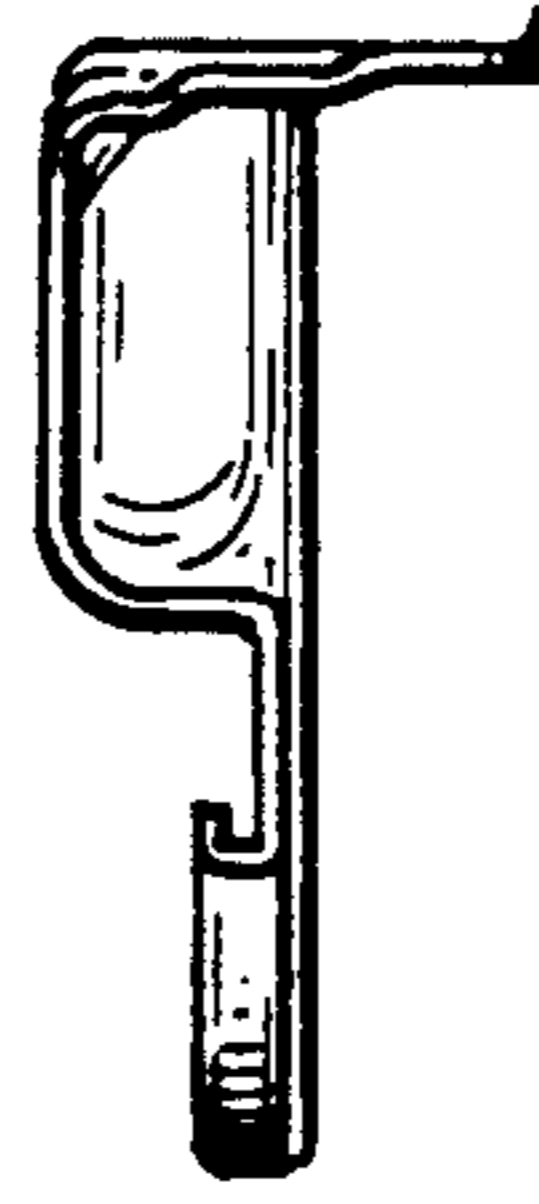

Fig. 11

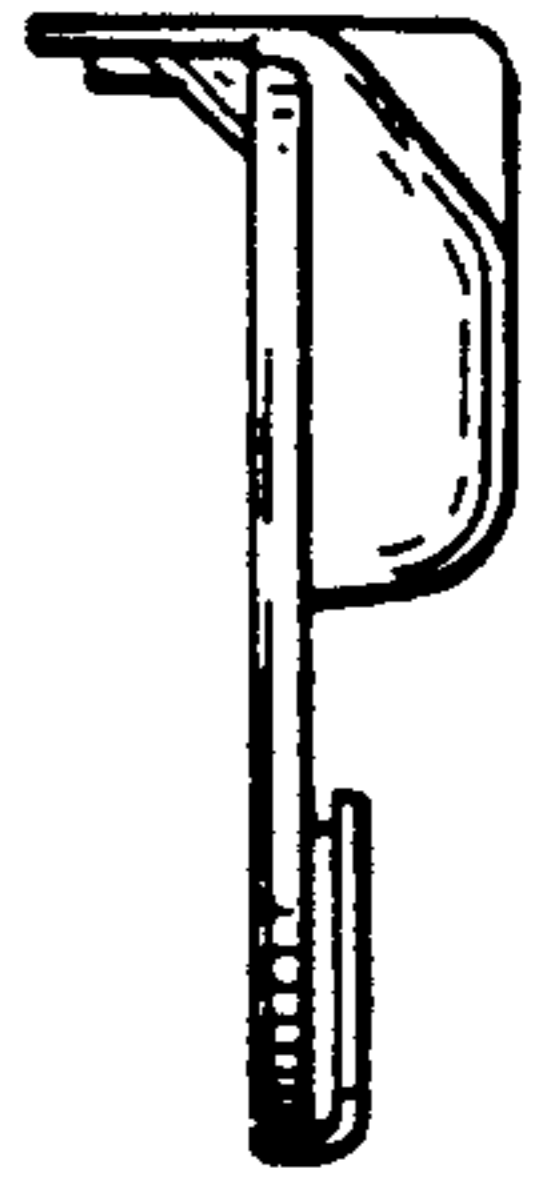

Fig. 10

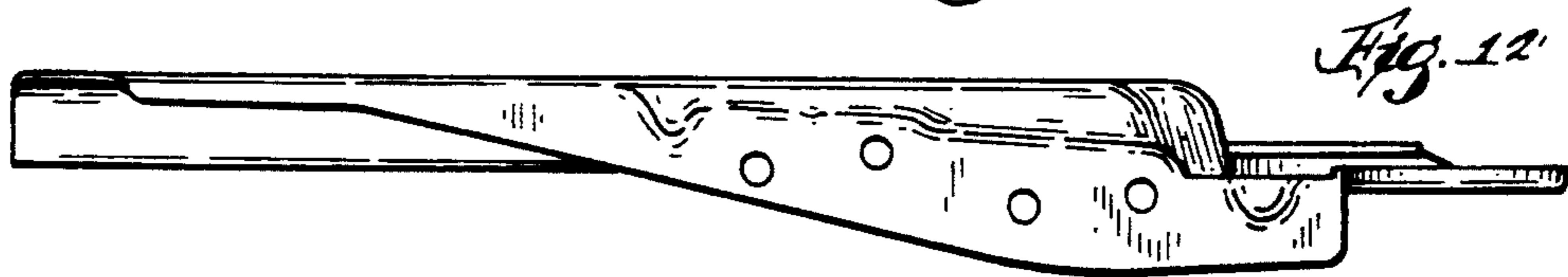

Fig. 12

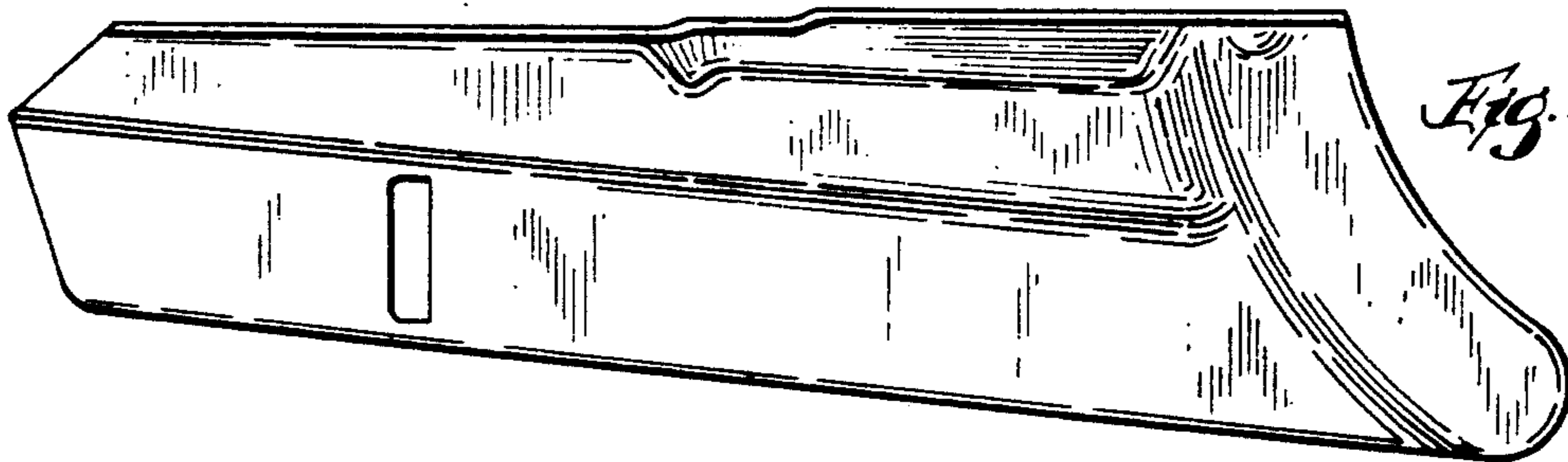

Fig. 9

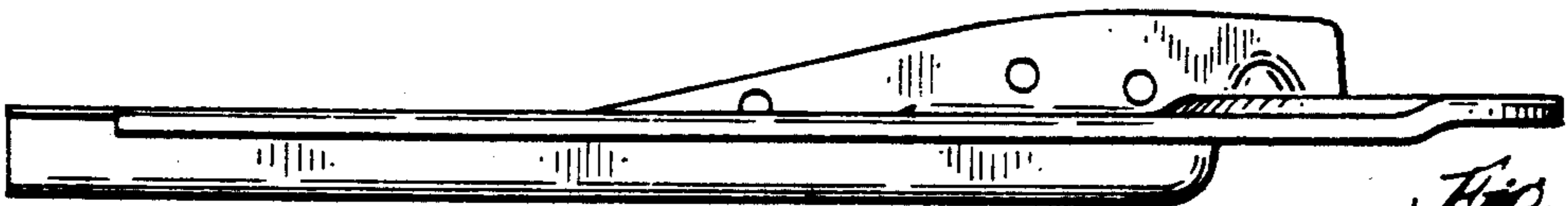

Fig. 13

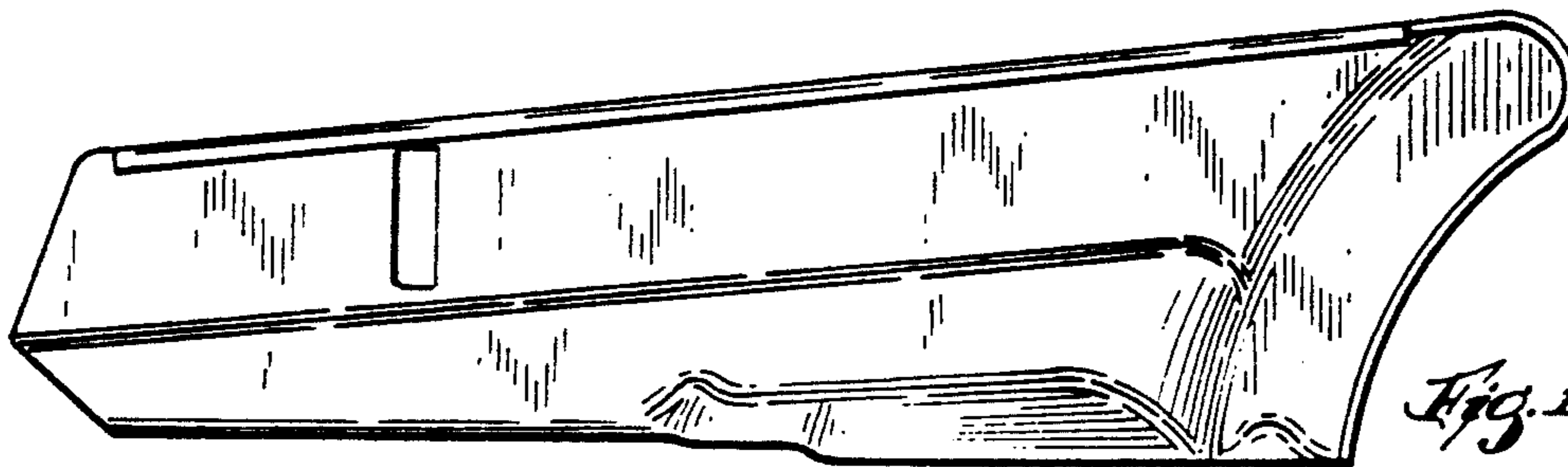

Fig. 14