



US00D344199S

United States Patent [19]

[11] Patent Number: **Des. 344,199**

Stephens

[45] Date of Patent: **** Feb. 15, 1994**

[54] **CREDENZA**

[75] Inventor: **William I. Stephens, Hereford Township, Berks County, Pa.**

[73] Assignee: **Westinghouse Electric Corp., Pittsburgh, Pa.**

[**] Term: **14 Years**

[21] Appl. No.: **9,669**

[22] Filed: **Jun. 21, 1993**

- D. 263,265 3/1982 Henley, Jr. D6/446
- D. 276,674 12/1984 Gwathmey et al. D6/446
- D. 296,282 6/1988 DePrins .
- D. 308,775 6/1990 Diekman .
- D. 336,392 6/1993 Whalen D6/446

OTHER PUBLICATIONS

World Furniture, by Helena Hayward, 1965, pp. 144 and 202.

Primary Examiner—Carmen H. Vales-Lado
Attorney, Agent, or Firm—Carla J. Vrsansky

Related U.S. Application Data

- [62] Division of Ser. No. 797,767, Nov. 21, 1991.
- [52] U.S. Cl. **D6/446**
- [58] Field of Search **D6/432-448;**
312/204, 224, 223, 225

[57] **CLAIM**

The ornamental design for a credenza, as shown and described.

[56] **References Cited**

U.S. PATENT DOCUMENTS

- D. 46,047 7/1914 Curtenius .
- D. 162,491 3/1951 Sussman .
- D. 164,417 9/1951 Hallward .
- D. 179,379 12/1956 Dailey .
- D. 188,116 6/1960 Roehm .
- D. 216,312 12/1969 Levey .
- D. 227,839 7/1973 Adkinson **D6/446**
- D. 231,172 4/1974 Carter **D6/446**
- D. 256,306 8/1980 Miklos .

DESCRIPTION

FIG. 1 is a perspective view of a credenza showing my new design;
 FIG. 2 is a front elevation view thereof;
 FIG. 3 is a right side elevation view thereof;
 FIG. 4 is a left side elevation view thereof;
 FIG. 5 is a top plan view thereof;
 FIG. 6 is a front elevation of a modified form of the credenza shown in FIG. 1, the side views being identical to those shown in FIGS. 3 and 4 respectively; and,
 FIG. 7 is a top plan view thereof.
 The rear of the credenza of both embodiments is flat and unornamented.

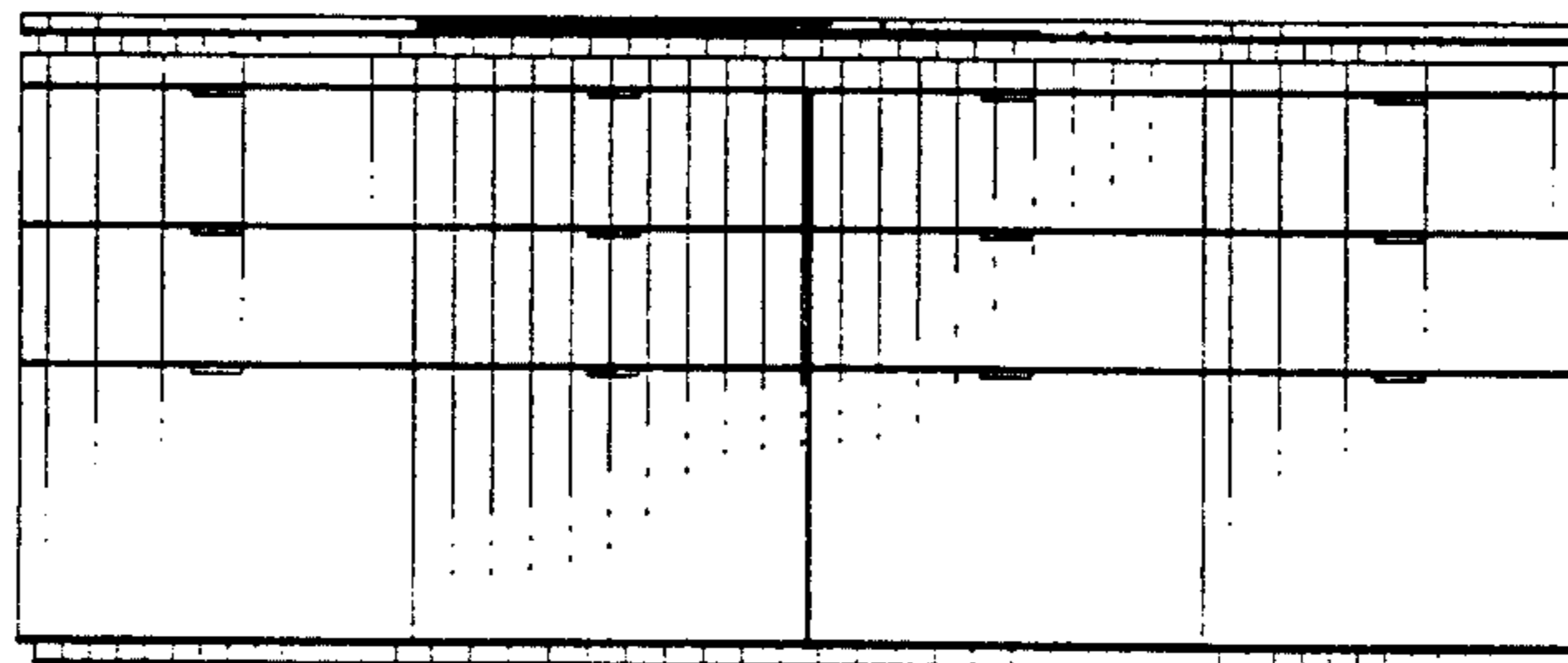
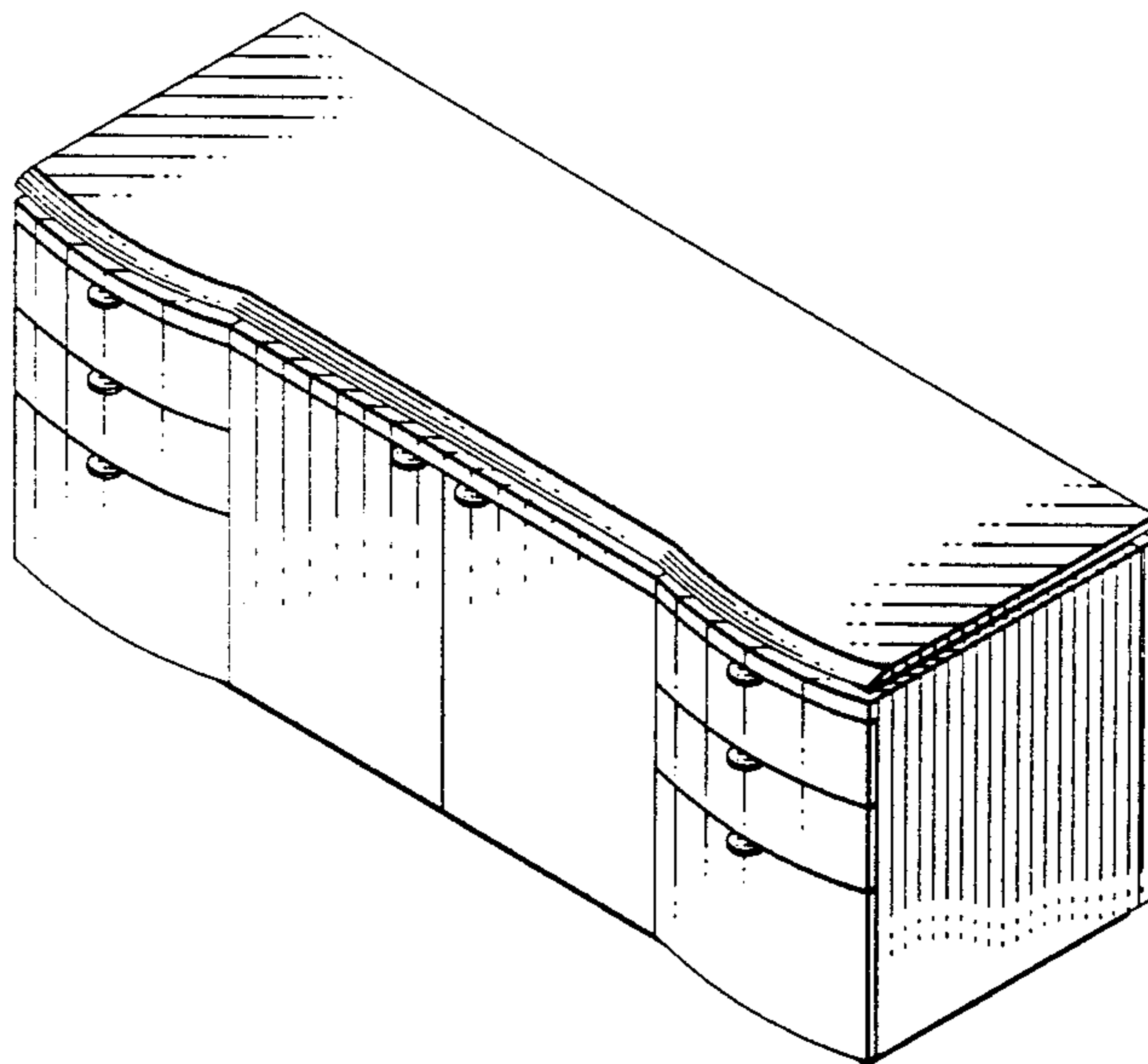

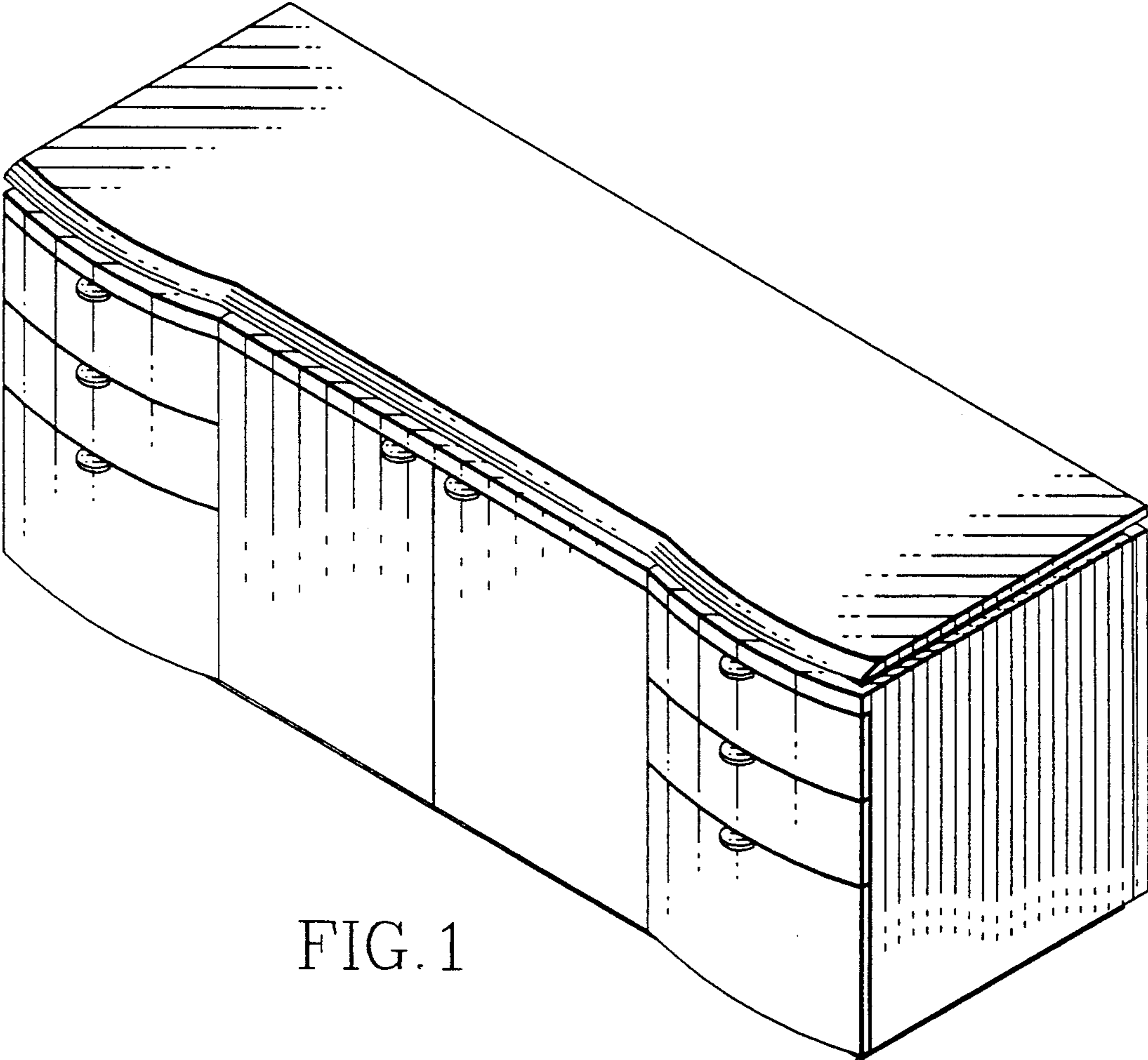

FIG. 1

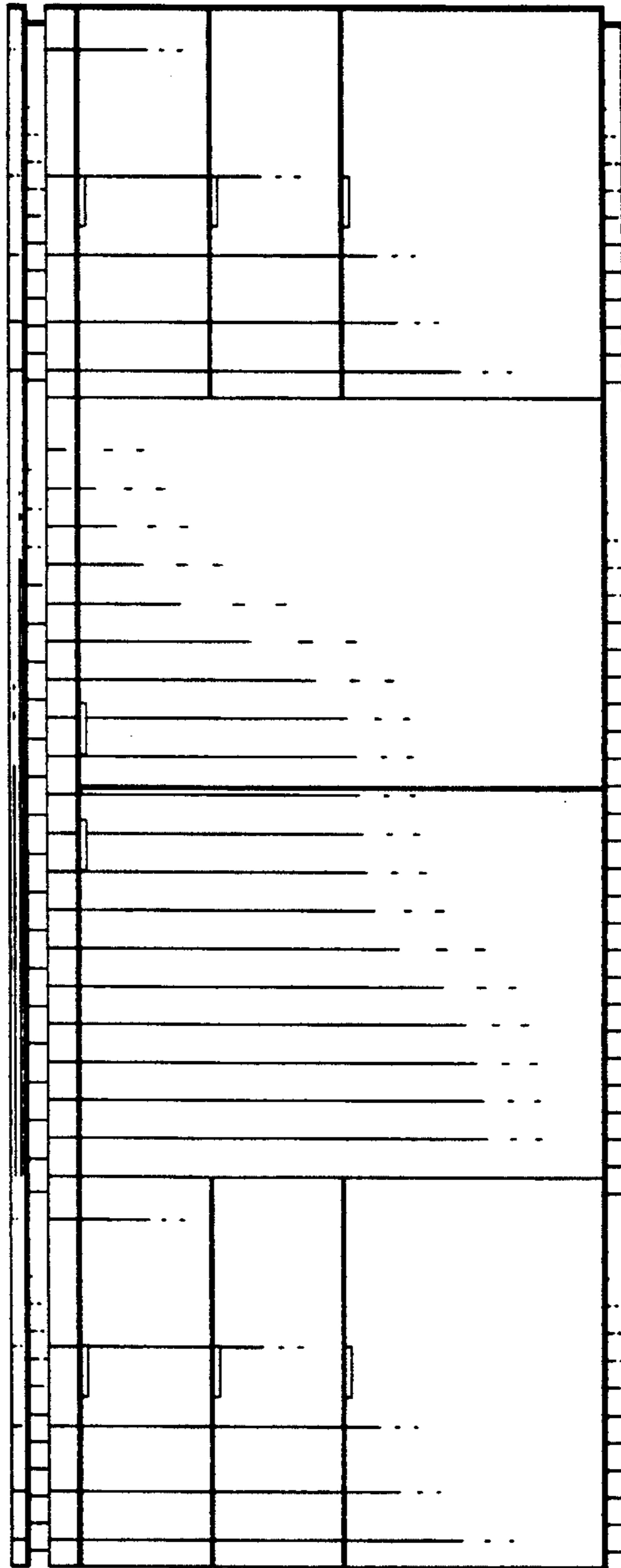

FIG. 2

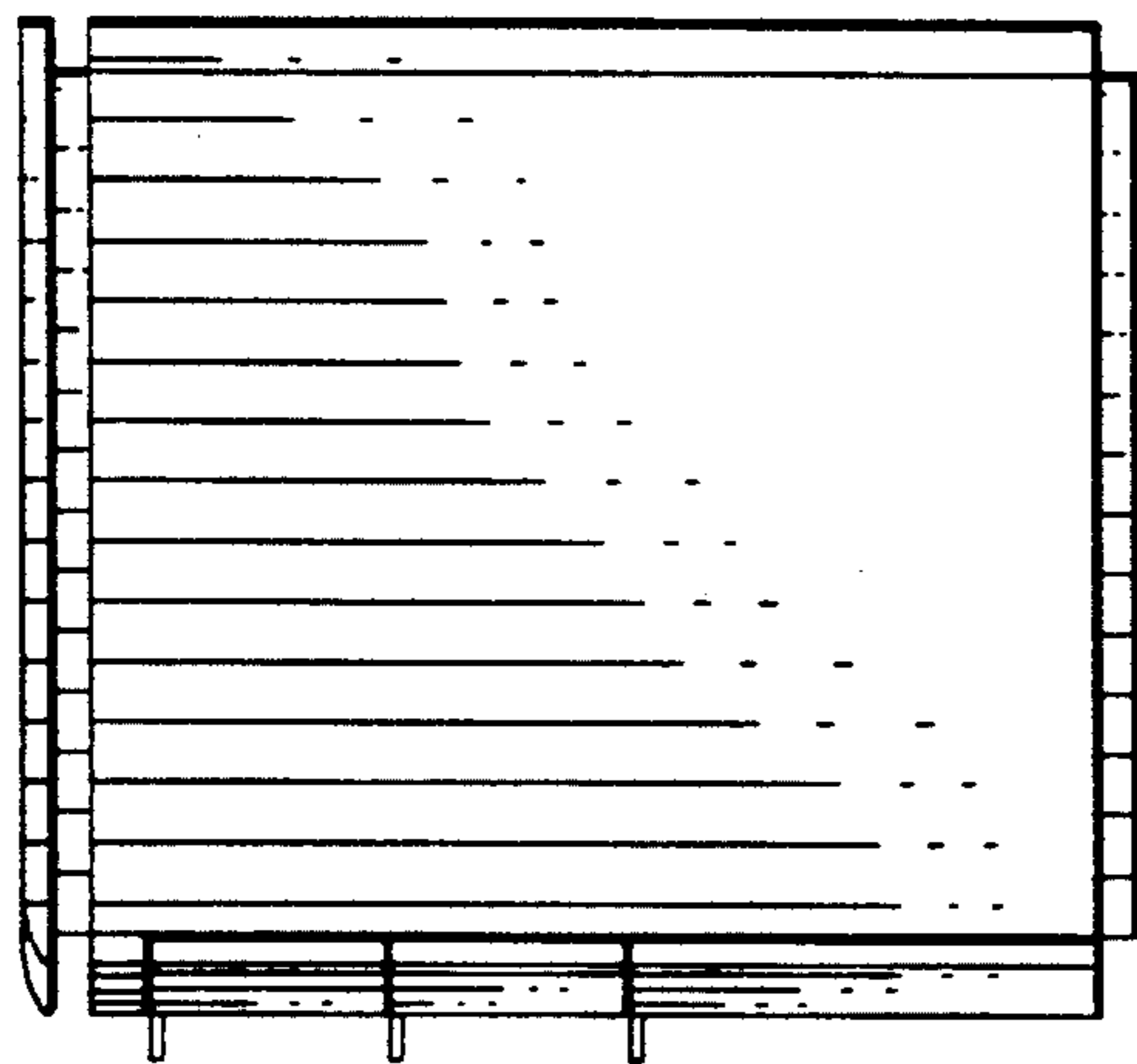

FIG. 3

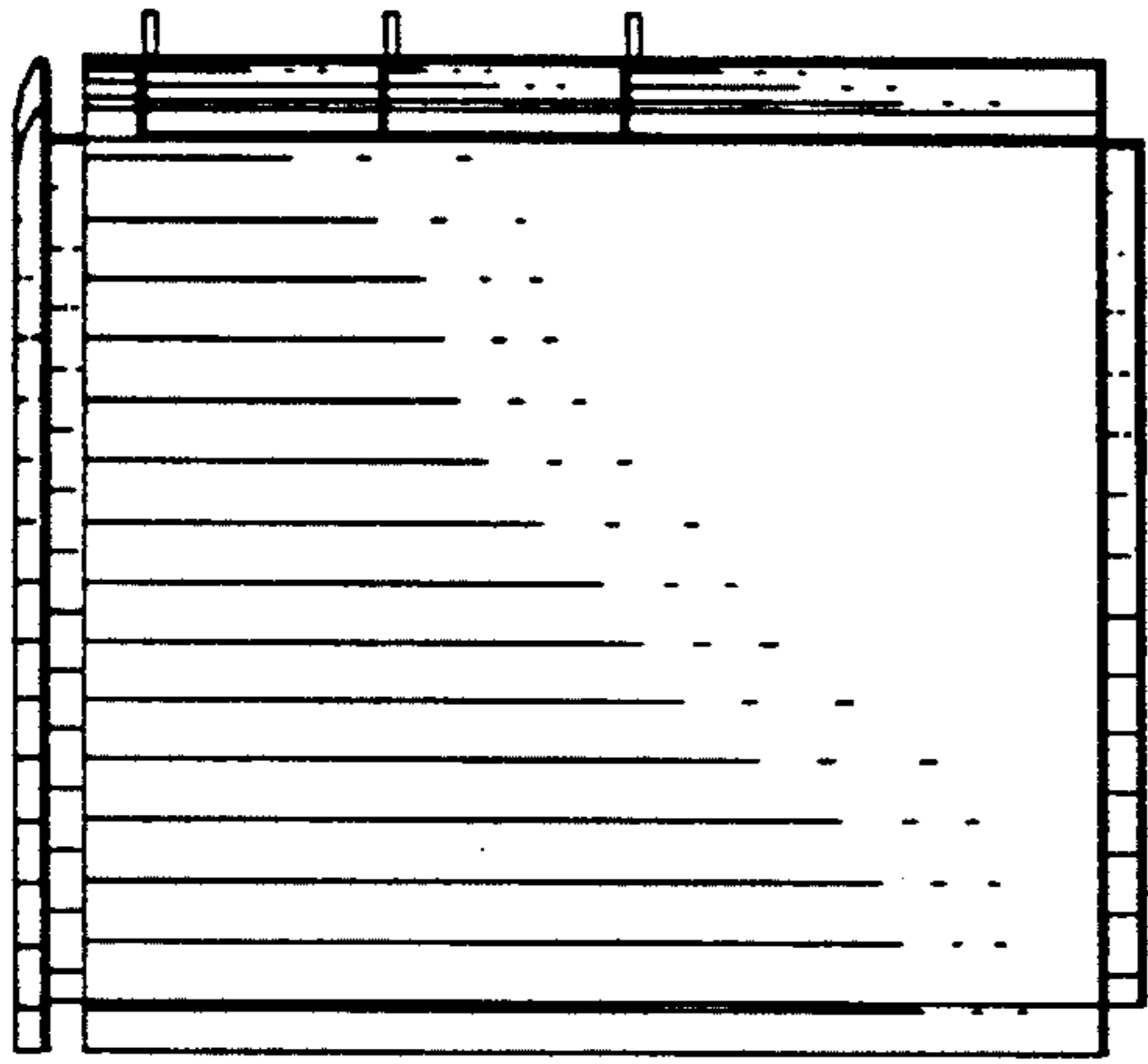

FIG. 4

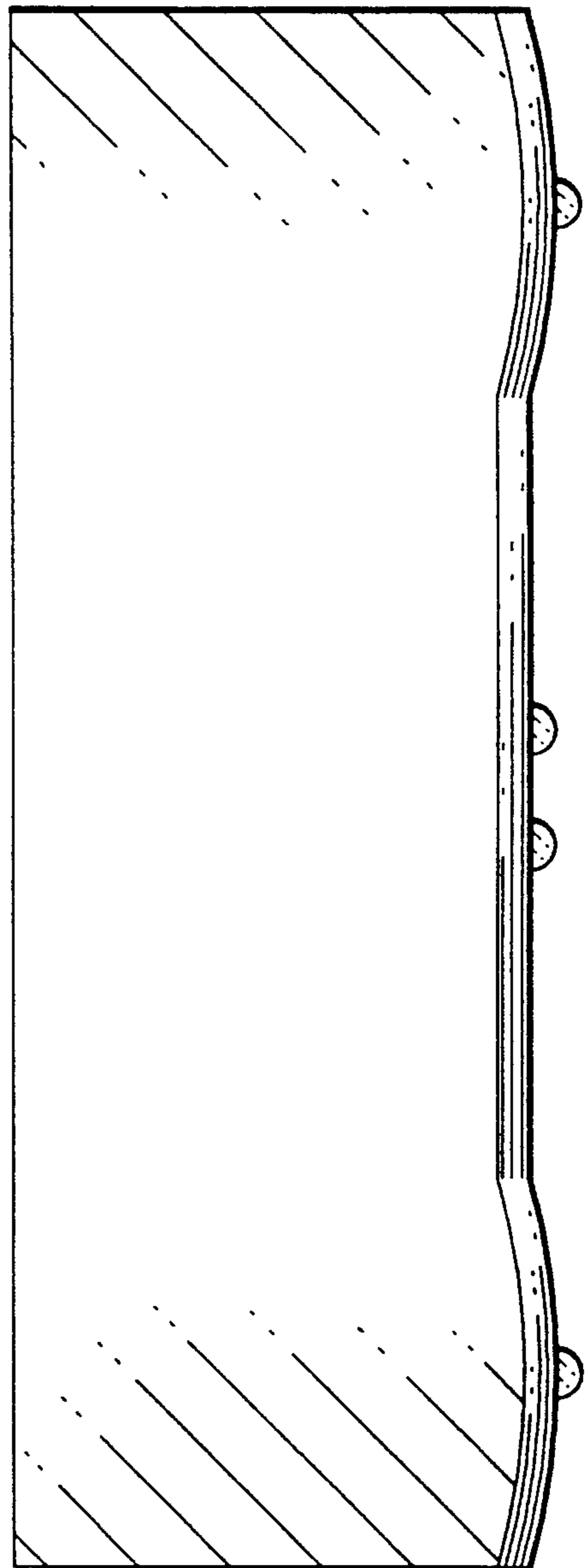

FIG. 5

FIG. 7

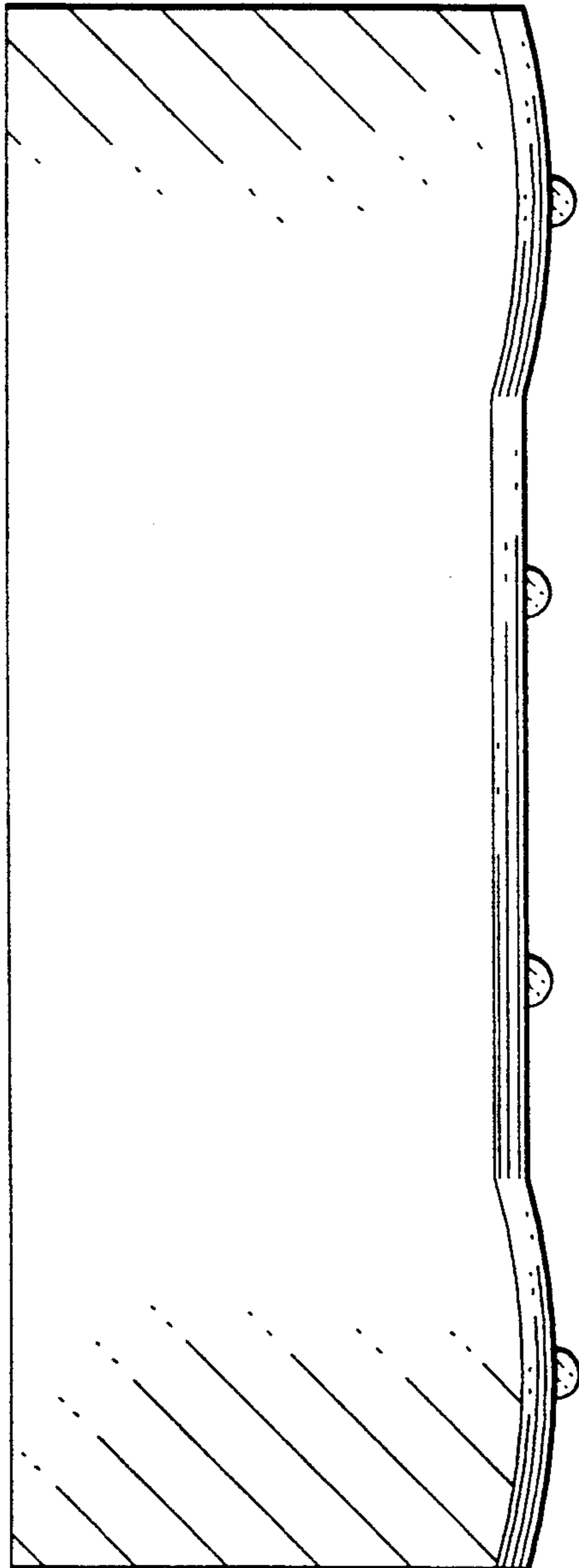

FIG. 6

