



US00D344190S

United States Patent [19] Fulcheri

[11] Patent Number: **Des. 344,190**

[45] Date of Patent: **** Feb. 15, 1994**

[54] OFFICE CHAIR

[75] Inventor: **Renato Fulcheri, Turin, Italy**

[73] Assignee: **Press S.p.A., Bra, Italy**

[**] Term: **14 Years**

[21] Appl. No.: **716,612**

[22] Filed: **Jun. 14, 1991**

[30] Foreign Application Priority Data

Apr. 24, 1991 [IT] Italy T091 O 000109

[52] U.S. Cl. **D6/366**

[58] Field of Search **D6/365, 366, 367, 368, D6/375, 379, 380; 297/DIG. 2, 301**

[56] References Cited

U.S. PATENT DOCUMENTS

- D. 254,878 5/1980 Ambasz D6/366
- D. 260,065 8/1981 Peterson D6/379
- D. 305,284 1/1990 Piretti D6/366
- D. 317,381 6/1991 Fulcheri D6/379 X
- 4,305,617 12/1981 Benoit 297/DIG. 2 X

FOREIGN PATENT DOCUMENTS

7804973 11/1978 Netherlands 297/301

Primary Examiner—Nelson C. Holtje

Assistant Examiner—Monica A. Hannon

Attorney, Agent, or Firm—Klauber & Jackson

[57] CLAIM

The ornamental design for an office chair, as shown and described.

DESCRIPTION

FIG. 1 is a front elevational view showing the office chair of my new design;
 FIG. 2 is a rear view thereof;
 FIG. 3 is a top view thereof;
 FIG. 4 is a bottom view thereof;
 FIG. 5 is a left-hand side view thereof;
 FIG. 6 is a right-hand side view thereof;
 FIG. 7 is a front elevational view of the base portion of the office chair of my new design;
 FIG. 8 is a rear view of the base portion of FIG. 7;
 FIG. 9 is a top view of the base portion of FIG. 7;
 FIG. 10 is a bottom view of the base portion of FIG. 7;
 FIG. 11 is a left-hand side view of the base portion of FIG. 7;
 FIG. 12 is a right-hand side view of the base portion of FIG. 7;
 FIG. 13 is a front elevational view of the seat and seat-back portion of the office chair of my new design;
 FIG. 14 is a rear view of the seat and seatback portion of FIG. 13;
 FIG. 15 is a top view of the seat and seatback portion of FIG. 13;
 FIG. 16 is a bottom view of the seat and seatback portion of FIG. 13;
 FIG. 17 is a left-hand side view of the seat and seatback portion of FIG. 13; and,
 FIG. 18 is a right-hand side view of the seat and seat-back portion of FIG. 13.
 FIGS. 7-18 shown specific features of the chair in-which the other areas have been omitted for clarity of illustration.

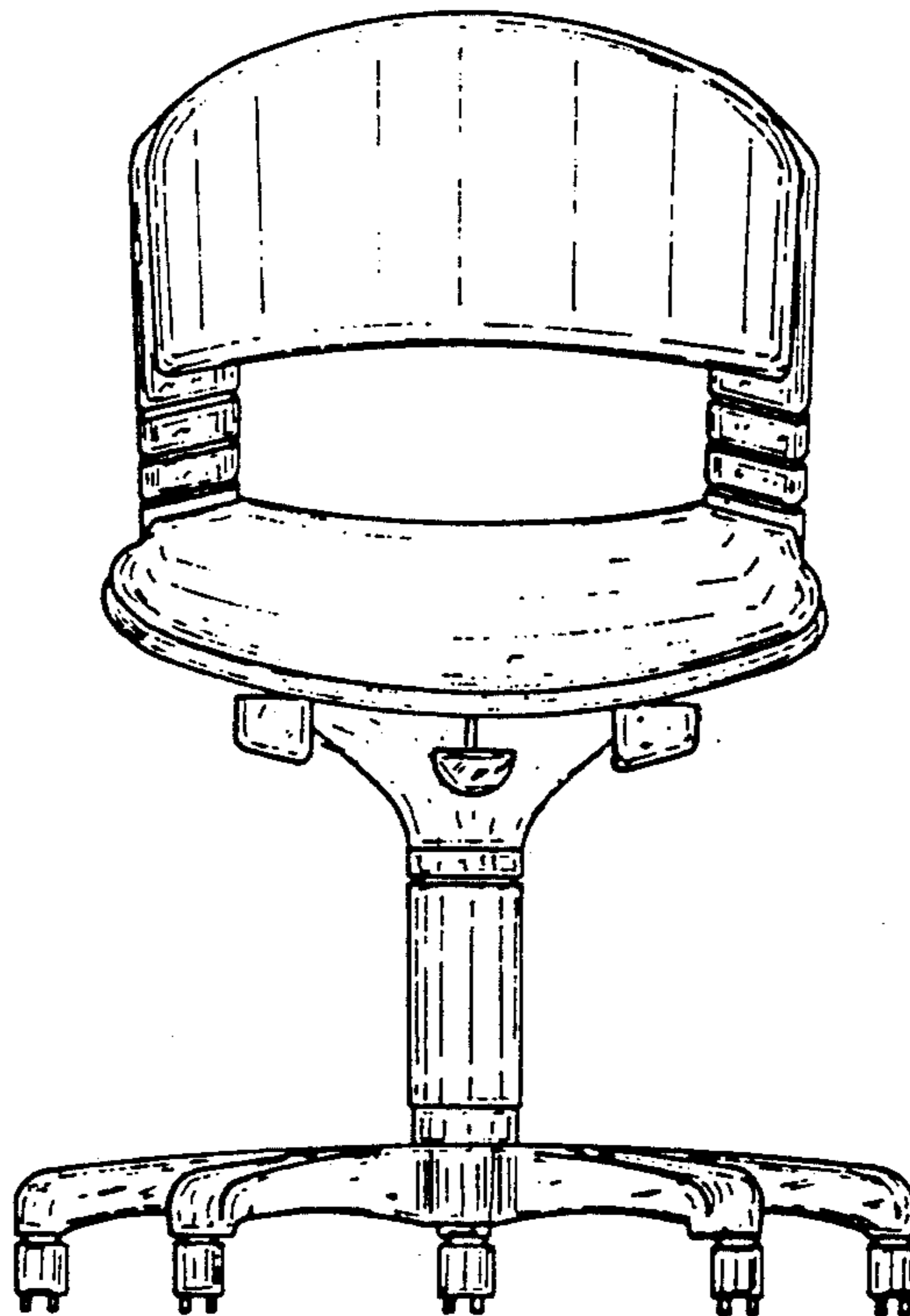

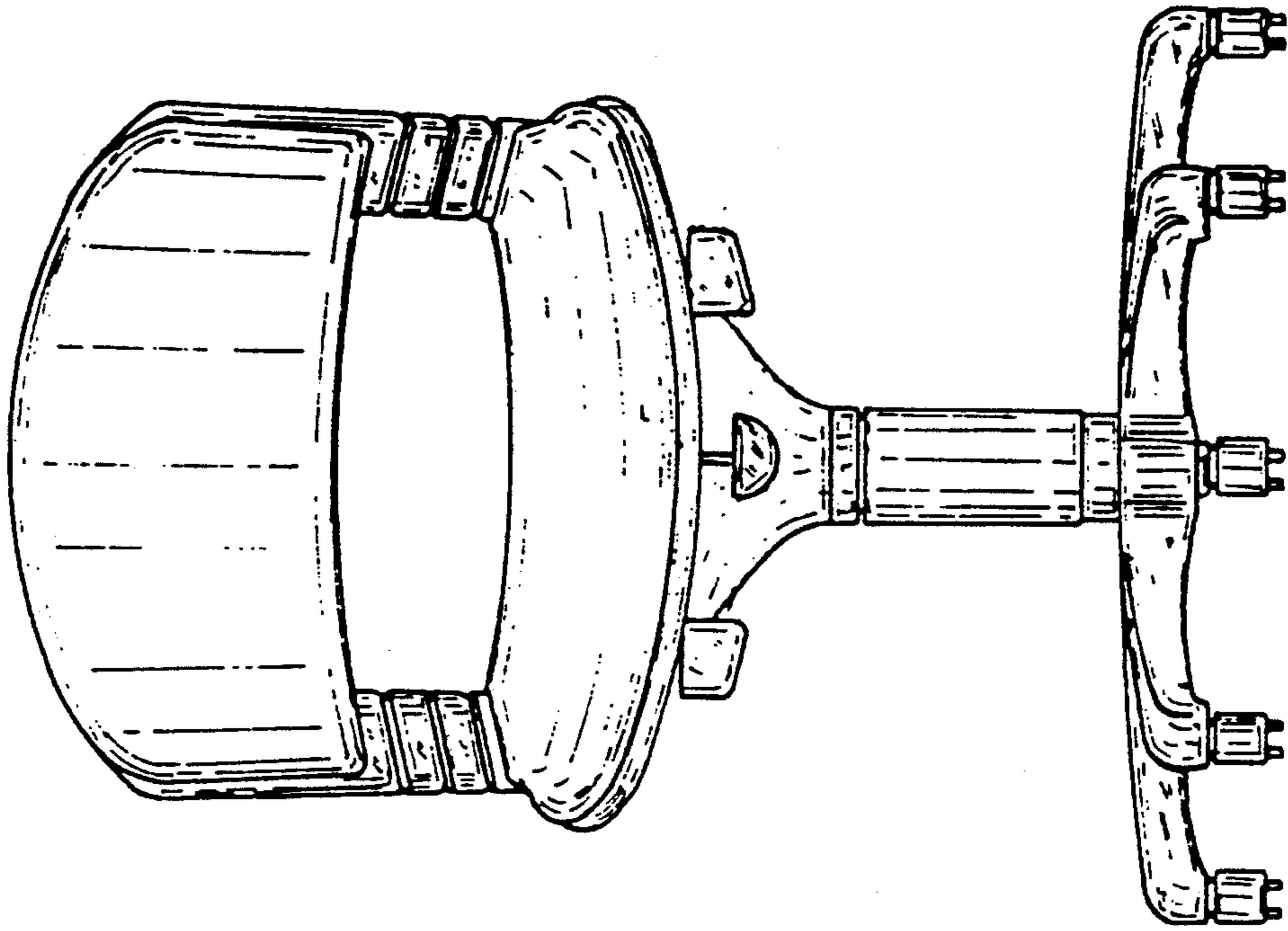

FIG. 1

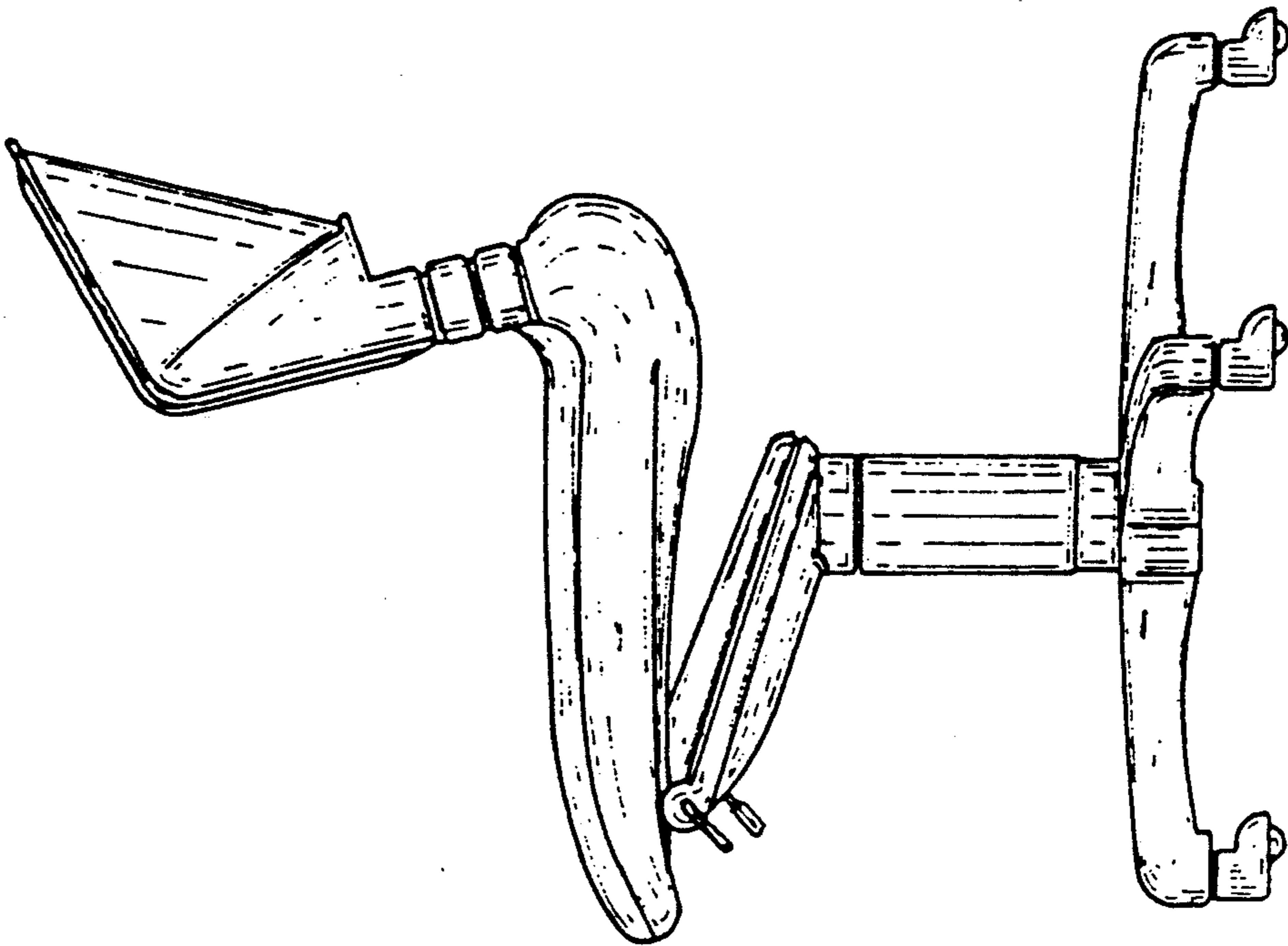

FIG. 5

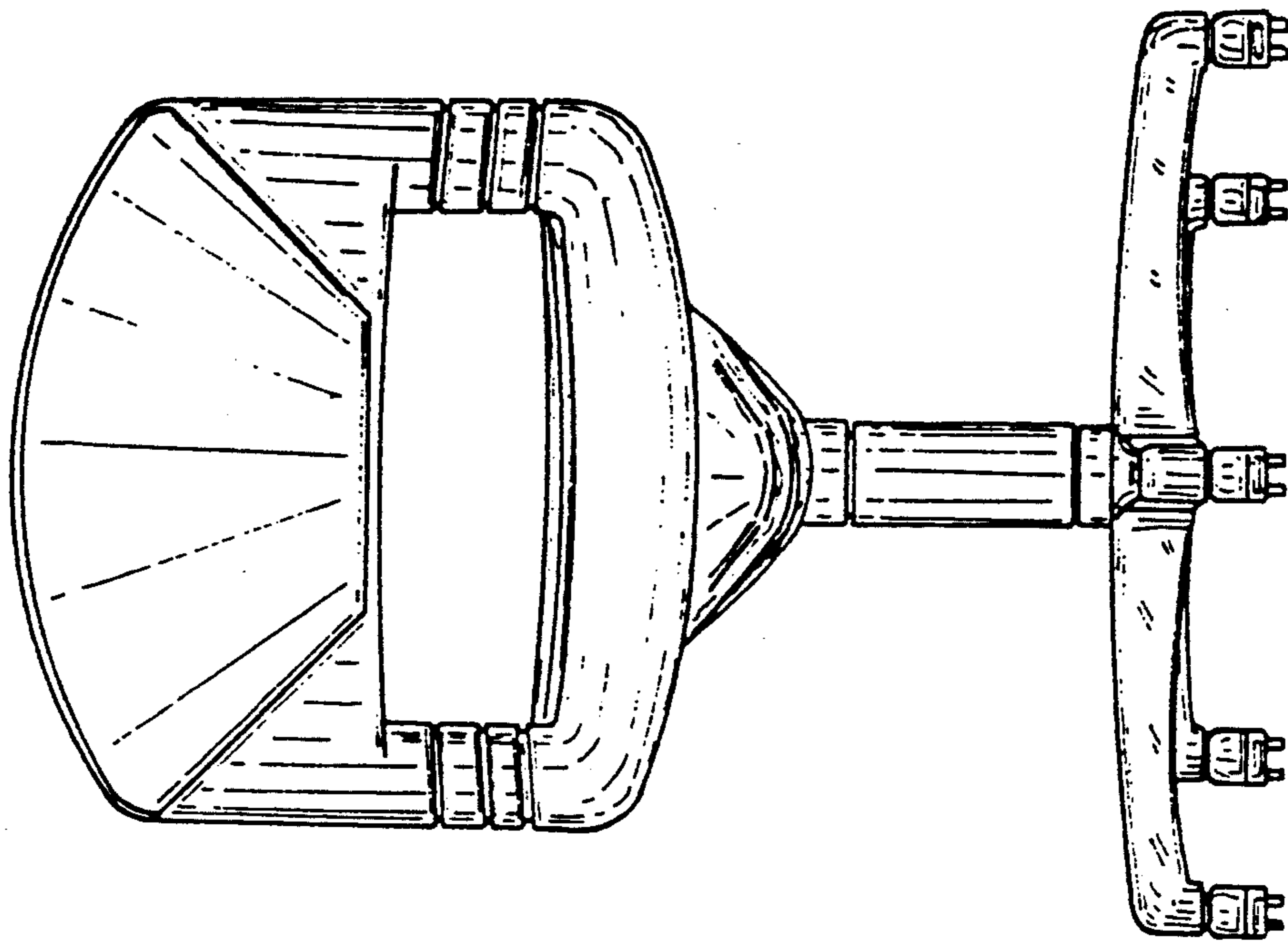

FIG. 2

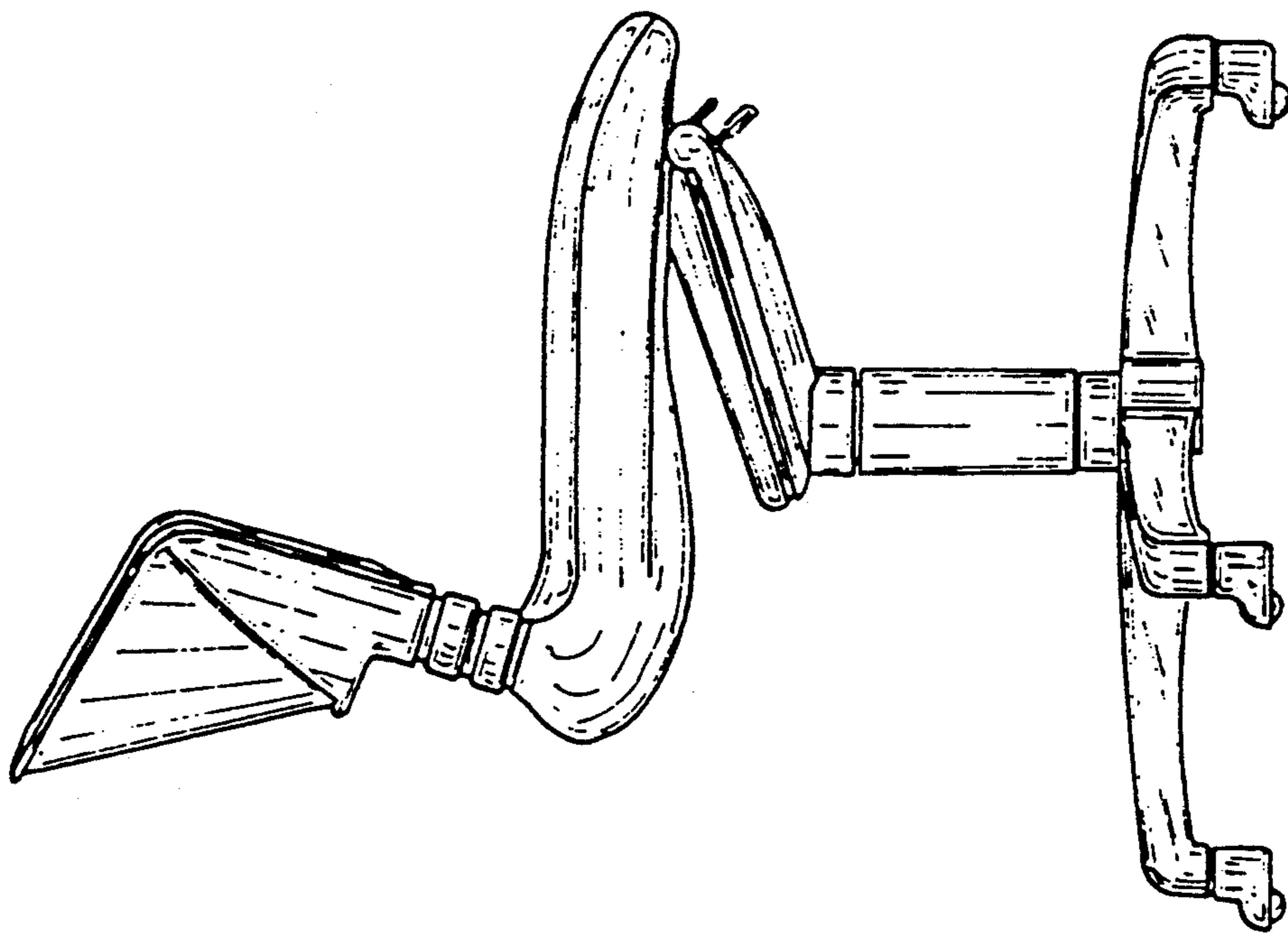

FIG. 6

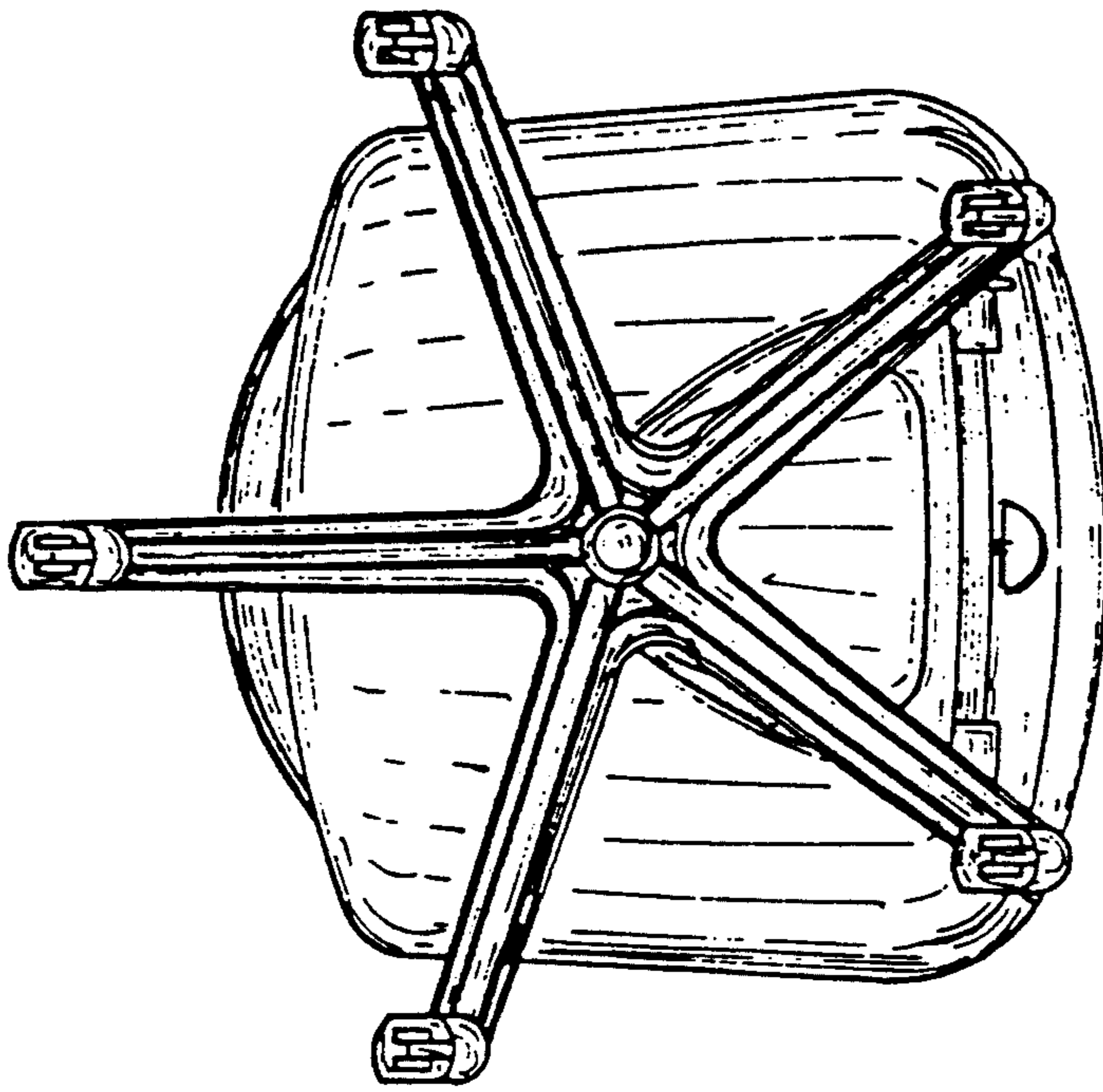

FIG. 4

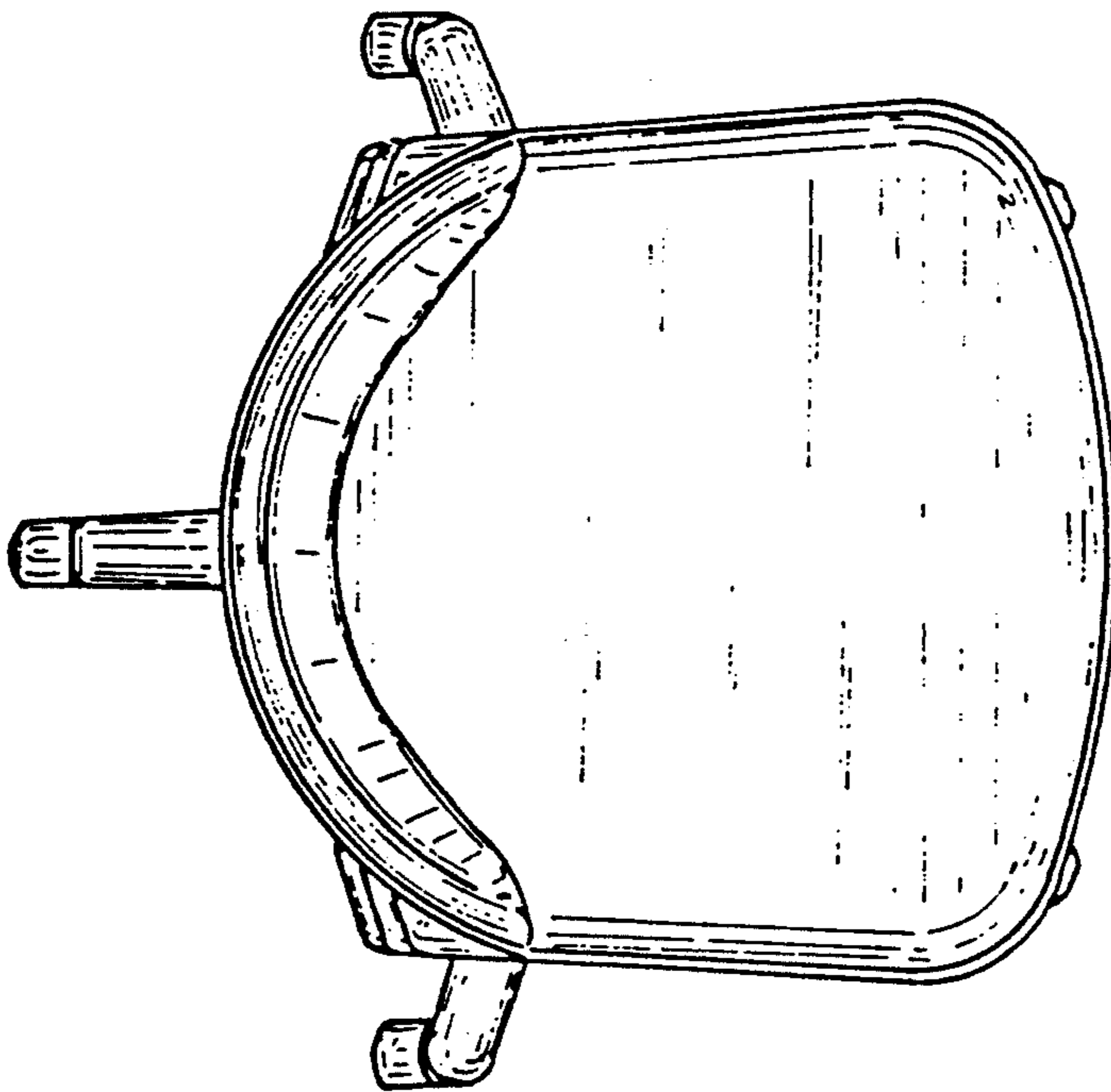

FIG. 3

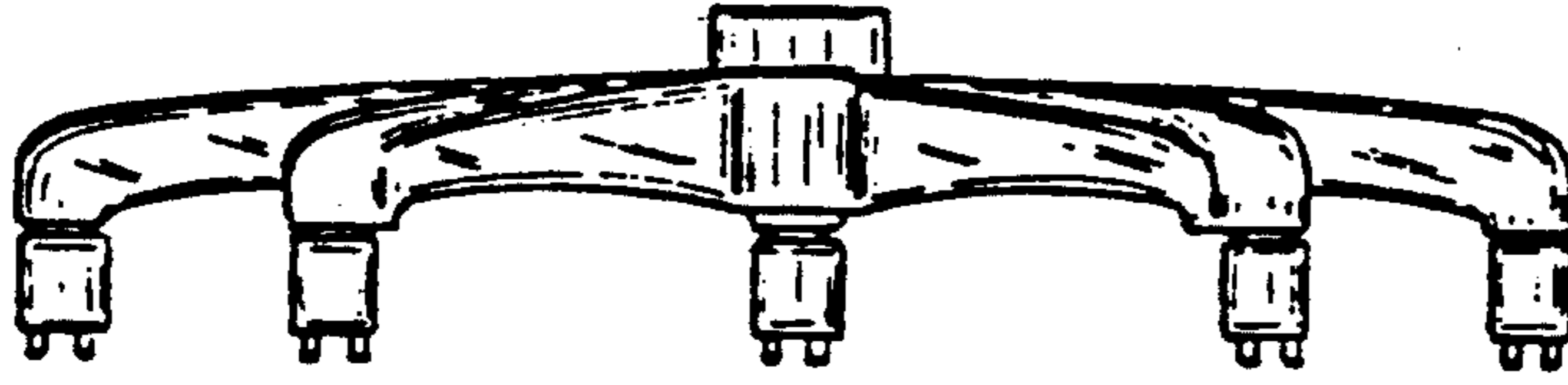

FIG. 7

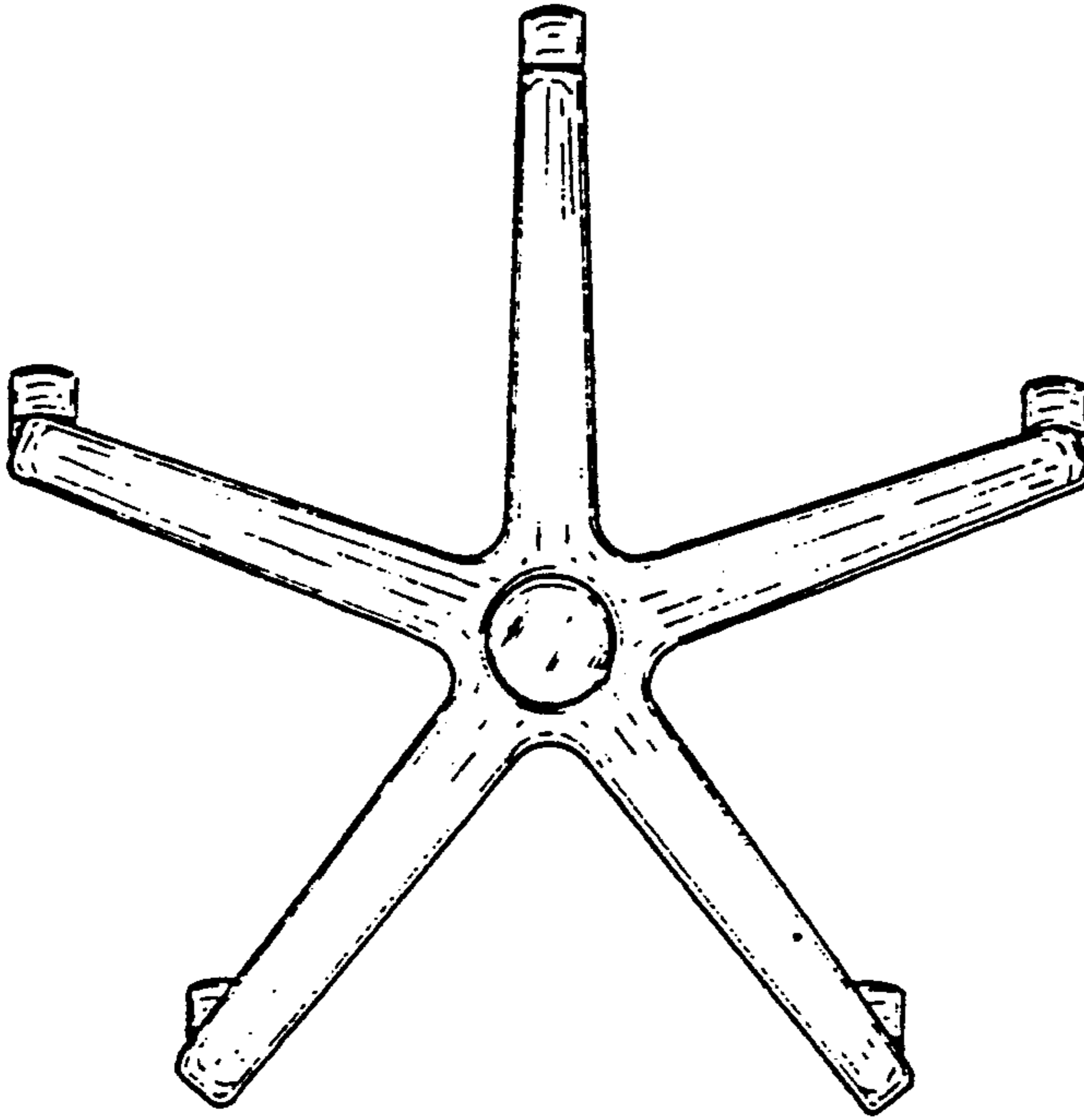

FIG. 9

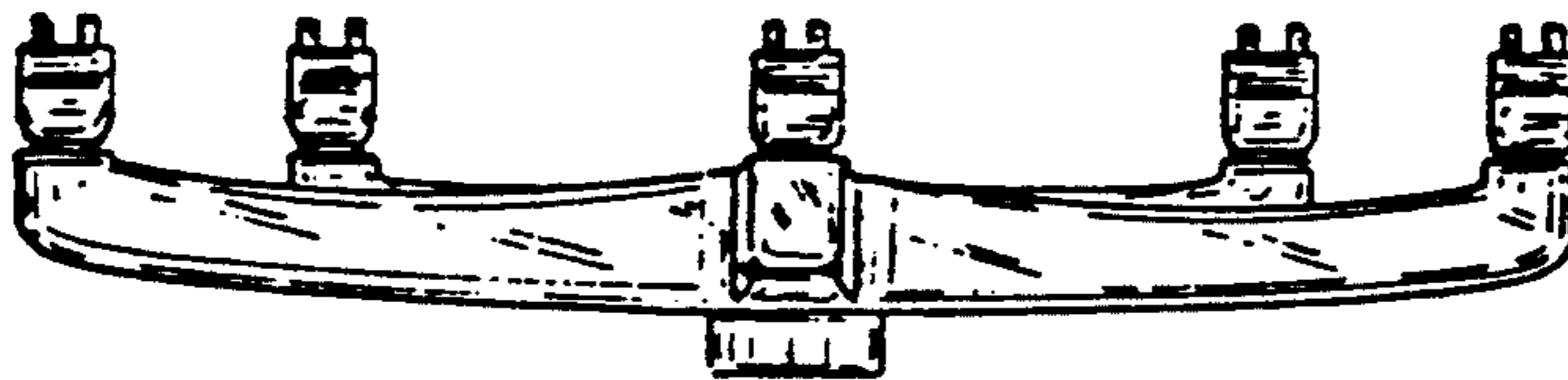

FIG. 8

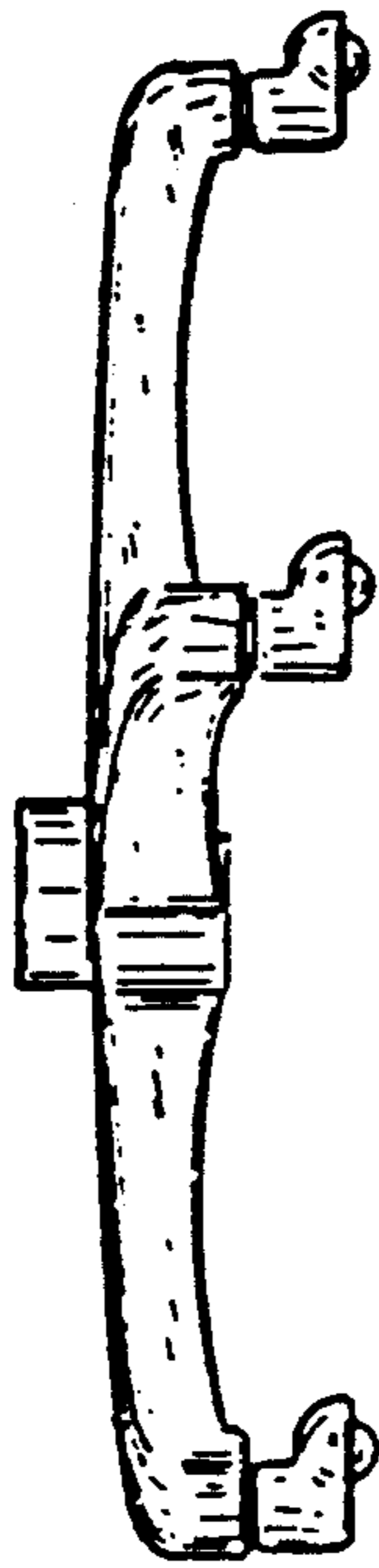

FIG. 11

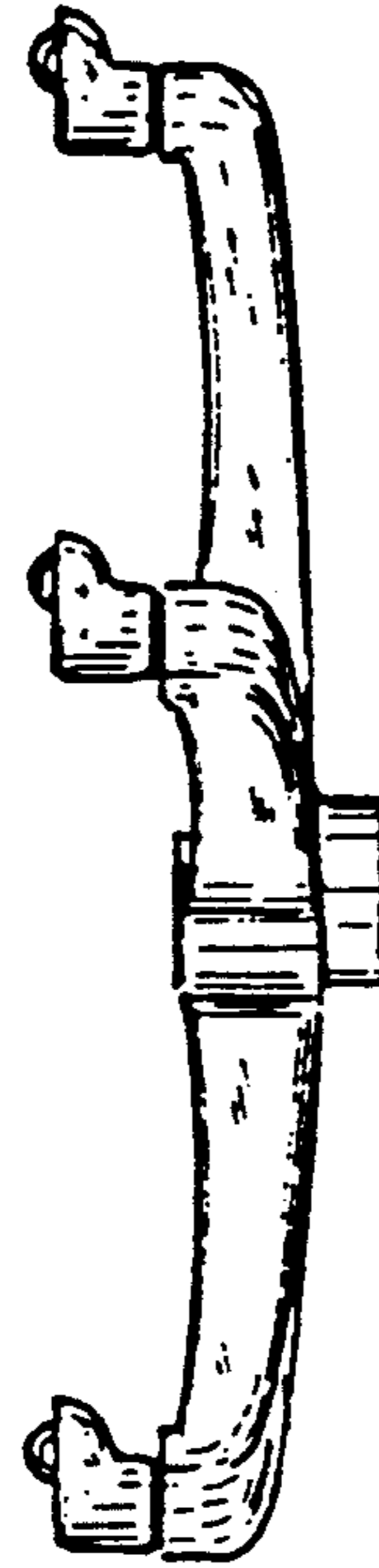

FIG. 12

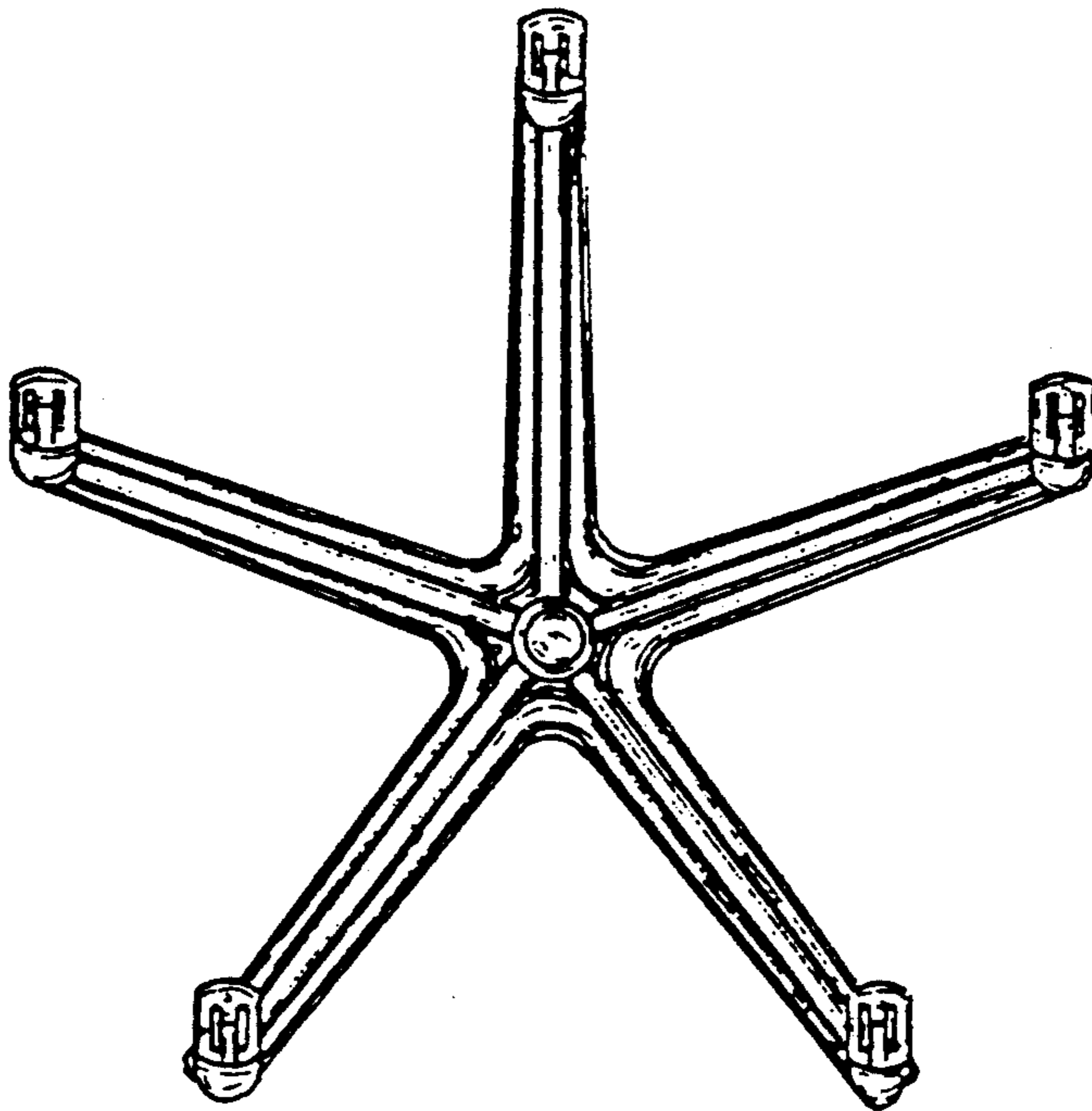

FIG. 10

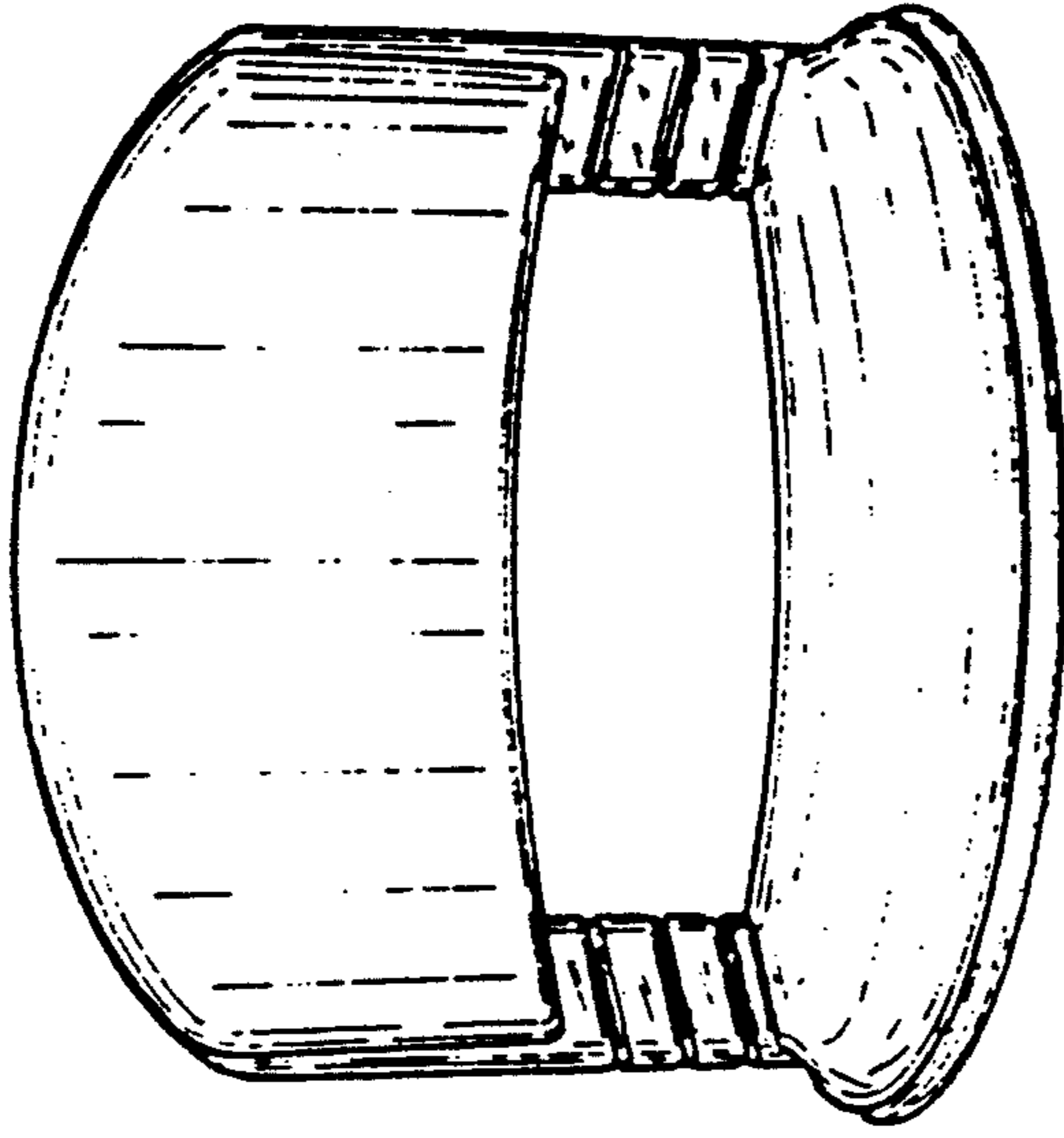

FIG. 13

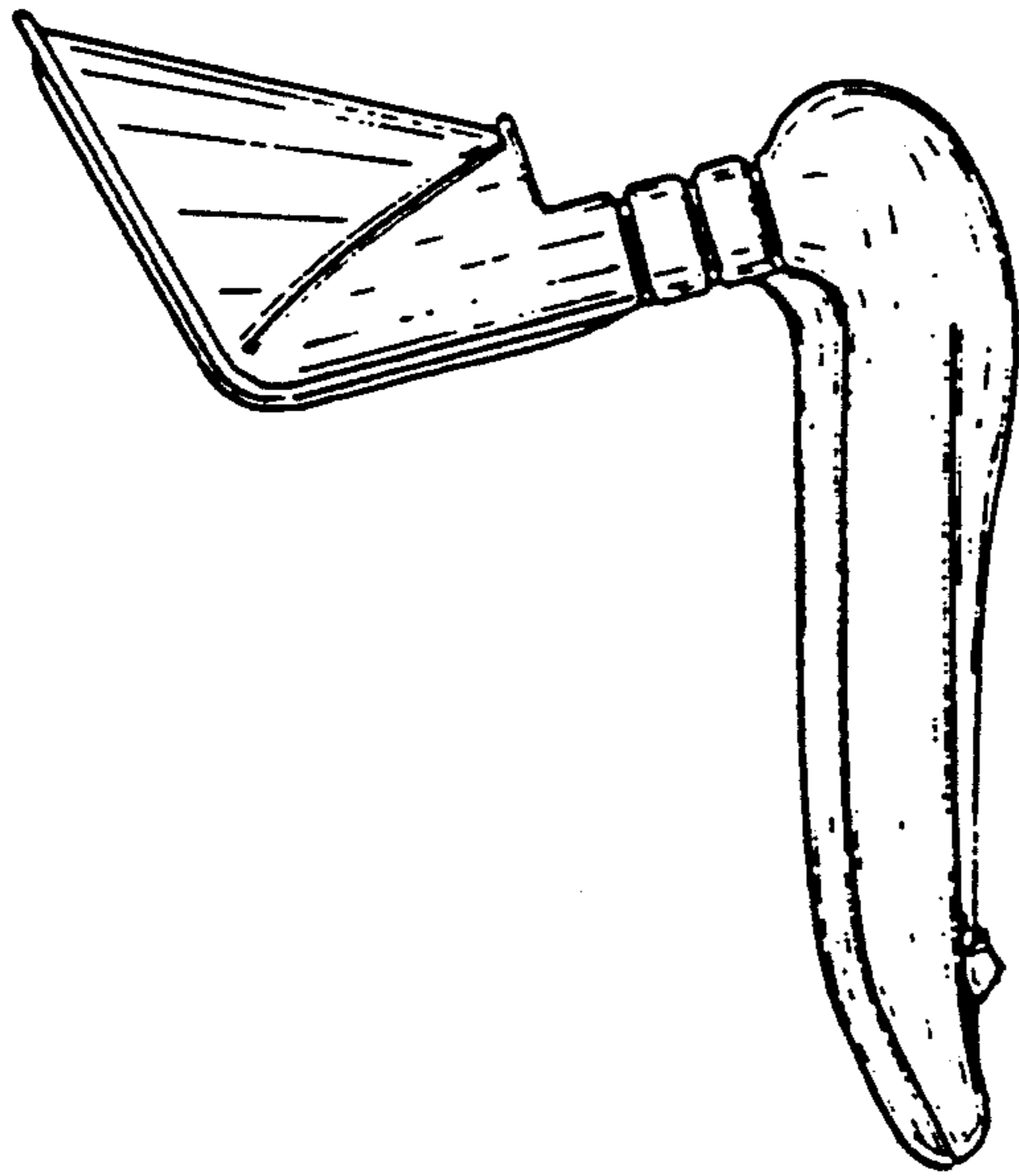

FIG. 17

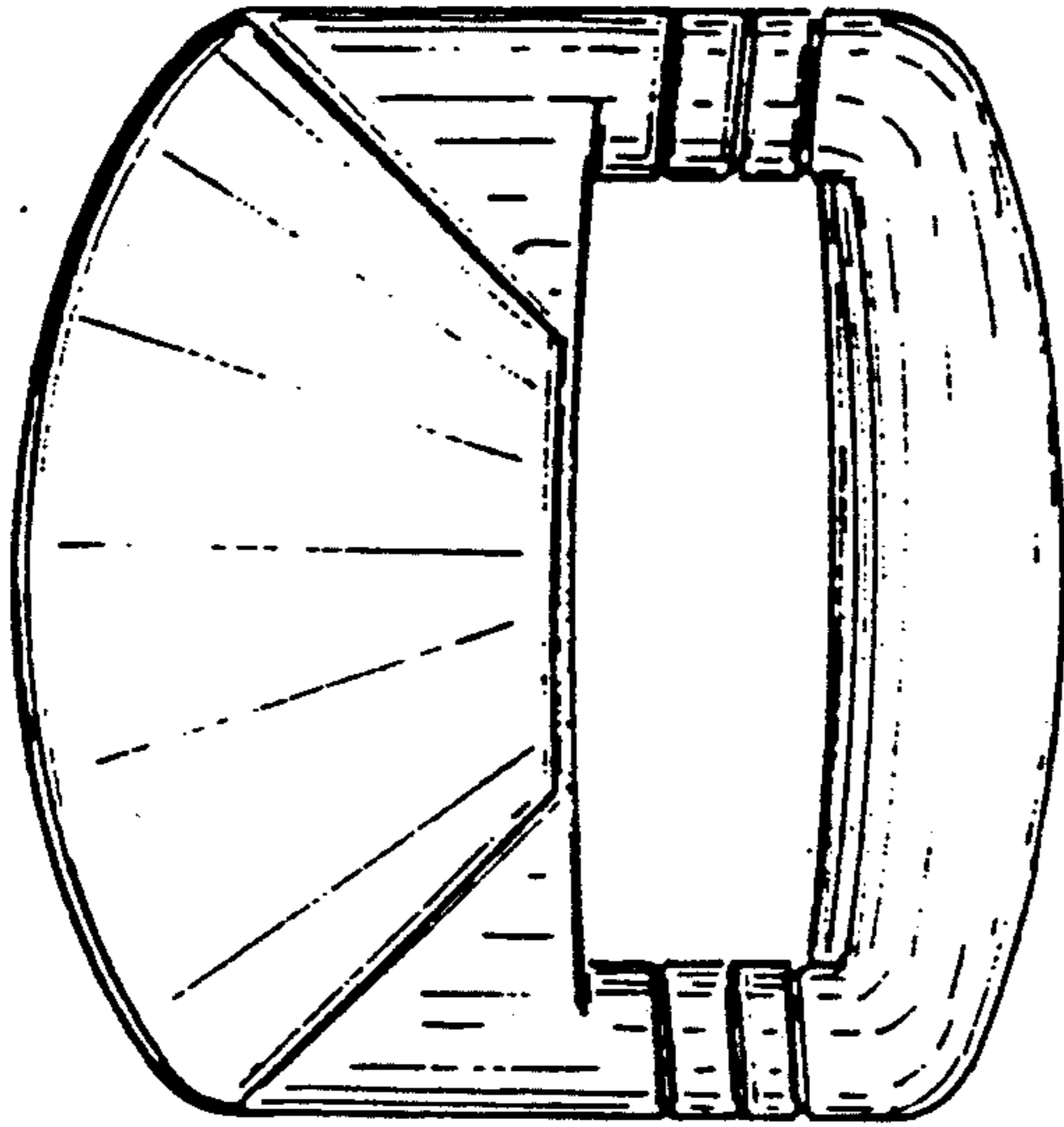

FIG. 14

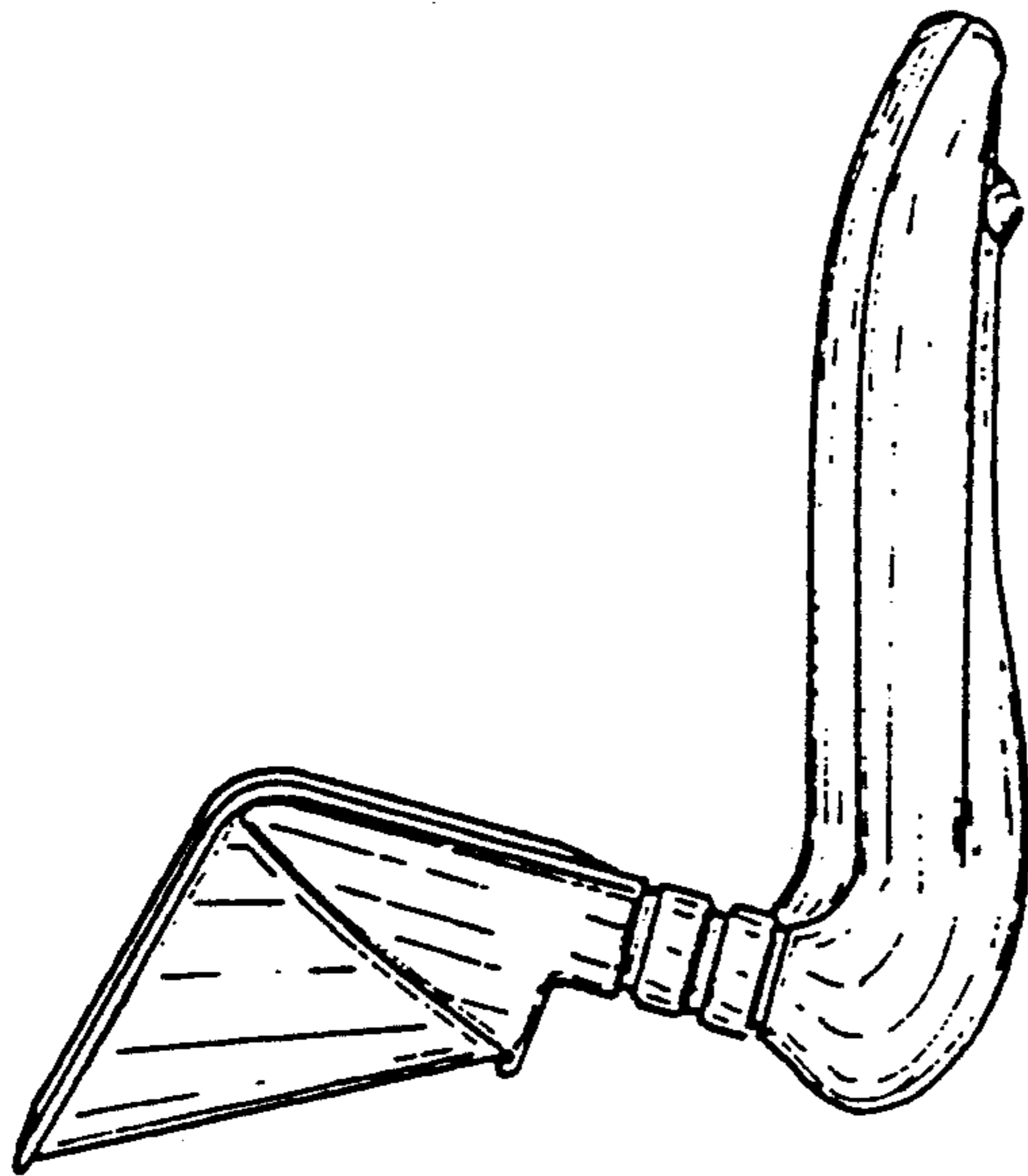

FIG. 18

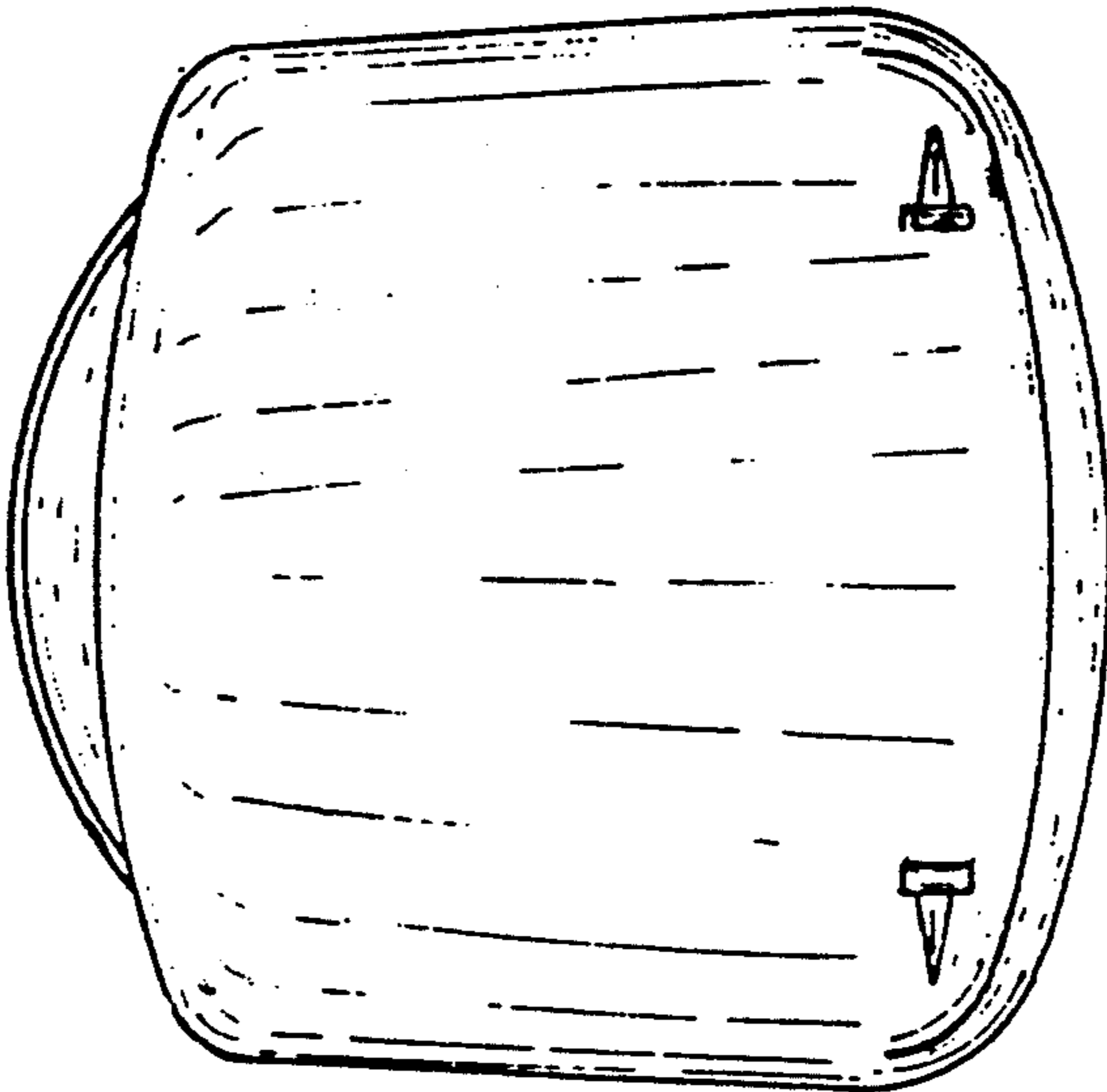

FIG. 16

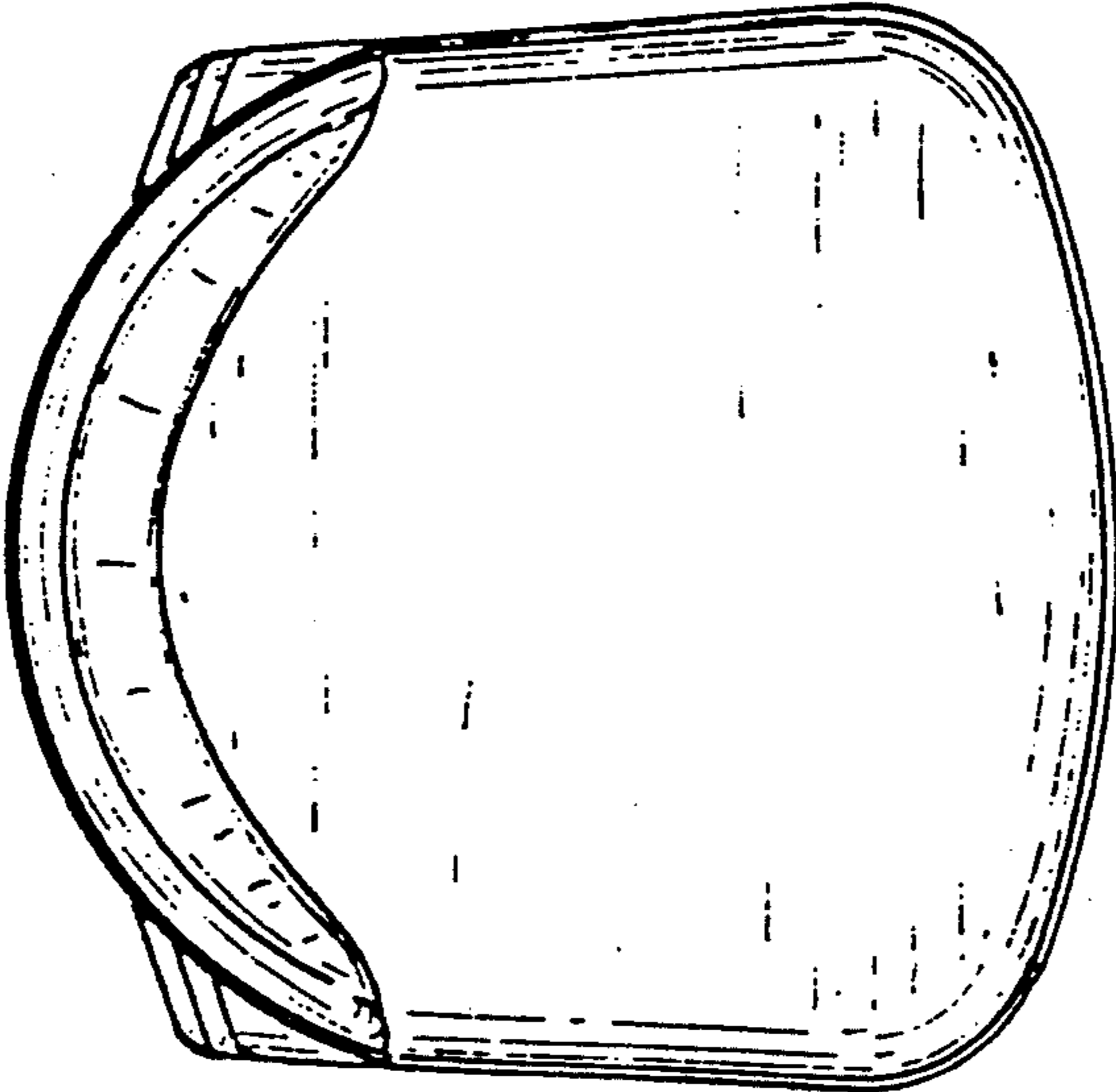

FIG. 15