



US00D344084S

United States Patent [19]

[11] Patent Number: **Des. 344,084**

Chen

[45] Date of Patent: **** Feb. 8, 1994**

[54] **TRANSPARENT DISPLAY PAGER BOX**

D. 327,066 6/1992 Scheid et al. D14/191

[76] Inventor: **Chen-Kuang Chen**, No. 3, Alley 14, Lane 85, Dingjow Road, Section 4, Taipei, Taiwan

Primary Examiner—Theodore M. Shooman
Attorney, Agent, or Firm—Bacon & Thomas

[**] Term: **14 Years**

[57] **CLAIM**

[21] Appl. No.: **817,676**

The ornamental design for a transparent display pager box, as shown and described.

[22] Filed: **Jan. 7, 1992**

DESCRIPTION

[52] U.S. Cl. **D14/191**

[58] Field of Search 455/90, 92, 100, 128; 340/311.1; D14/124, 191, 192, 299

FIG. 1 is a perspective view of a transparent display pager box showing my new design;

FIG. 2 is a front elevational view thereof;

FIG. 3 is a rear elevational view thereof;

FIG. 4 is a side elevational view thereof;

FIG. 5 is an elevational view of the side opposite to FIG. 4;

FIG. 6 is a top plan view thereof; and,

FIG. 7 is a bottom plan view thereof.

[56]

References Cited

U.S. PATENT DOCUMENTS

- D. 303,667 9/1989 Scheid et al. D14/191
- D. 303,969 10/1989 Scheid et al. D14/191
- D. 325,911 5/1992 Scheid et al. D14/191

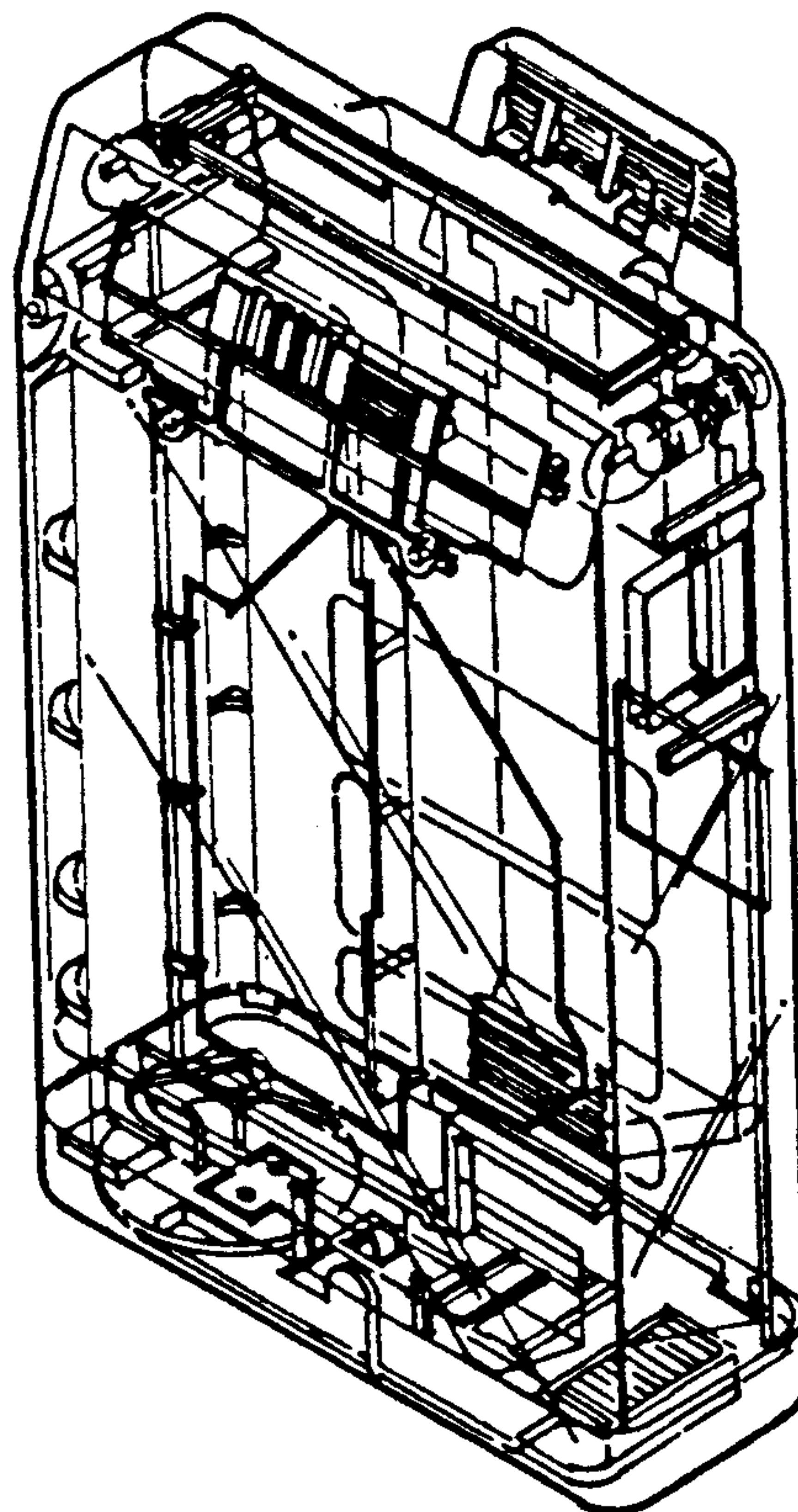

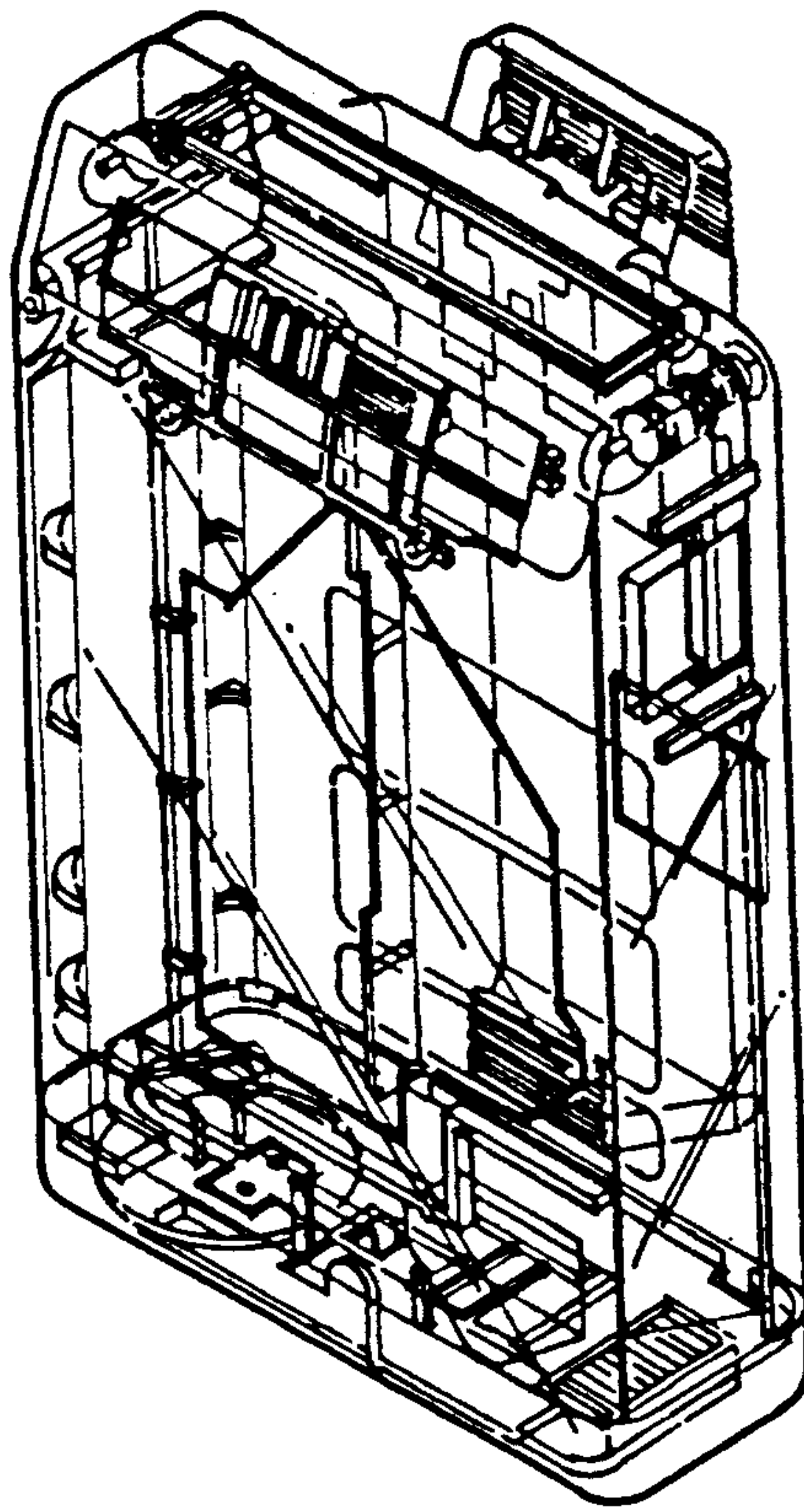

FIG 1

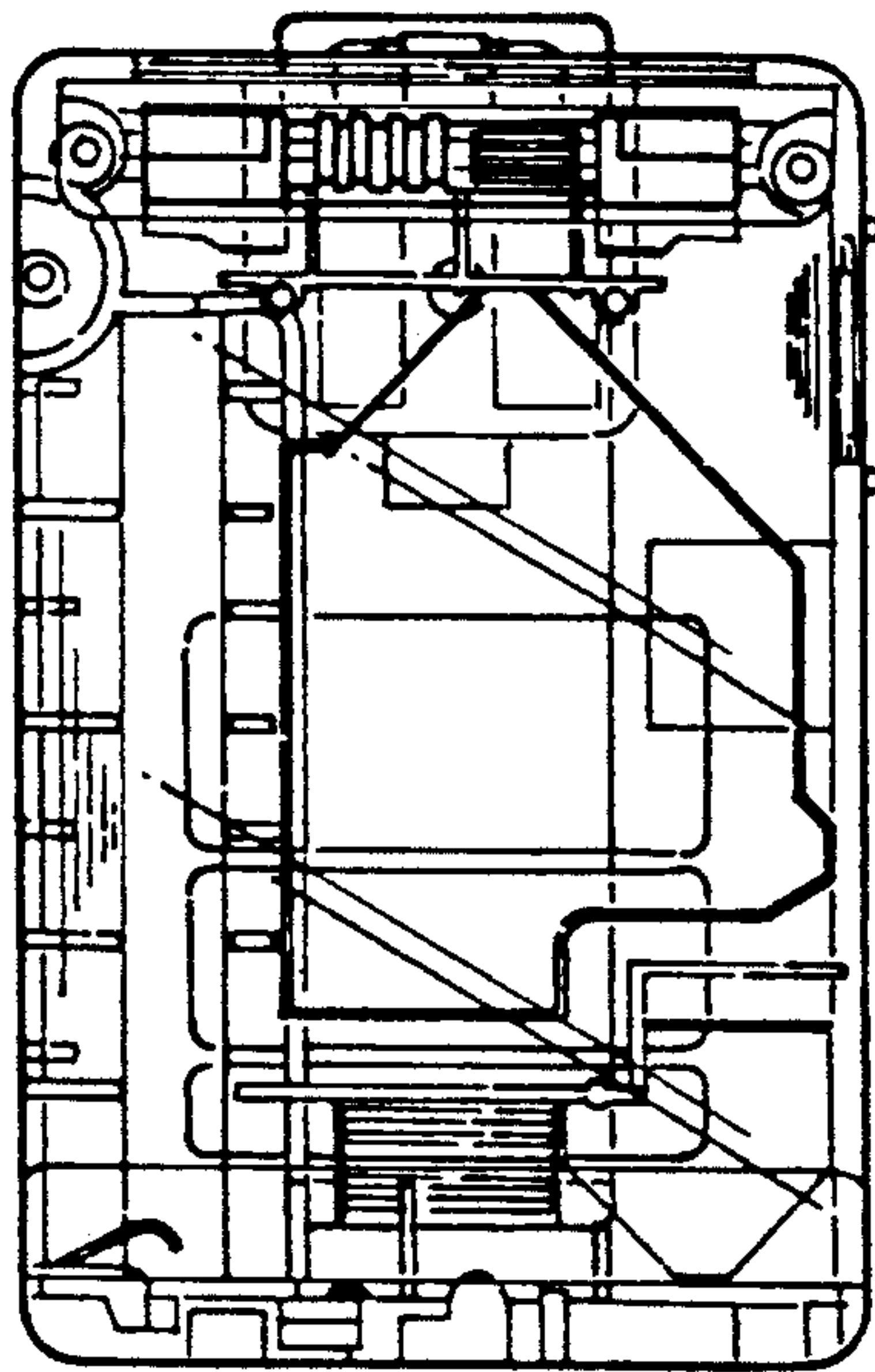

FIG 2

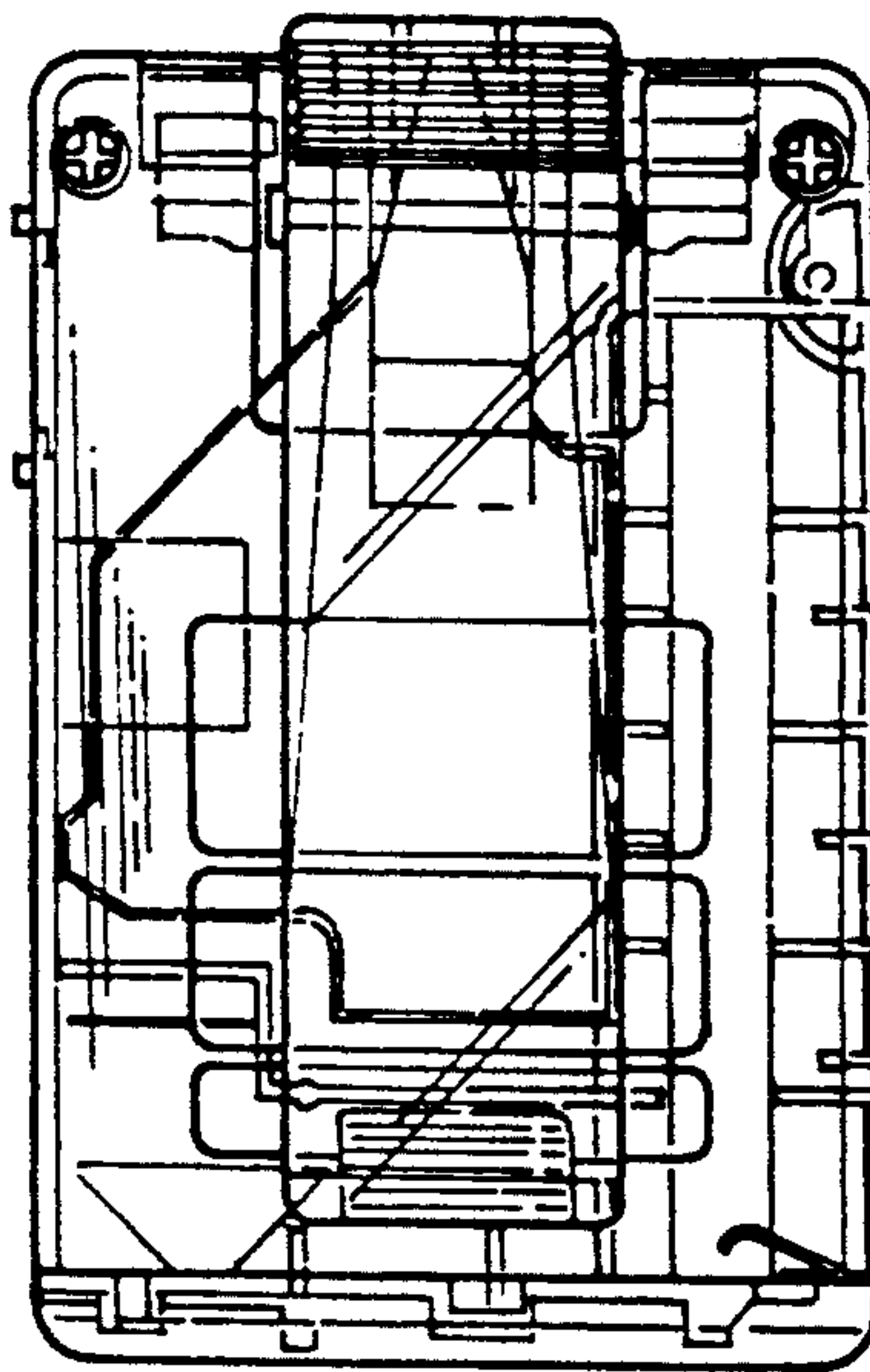

FIG 3

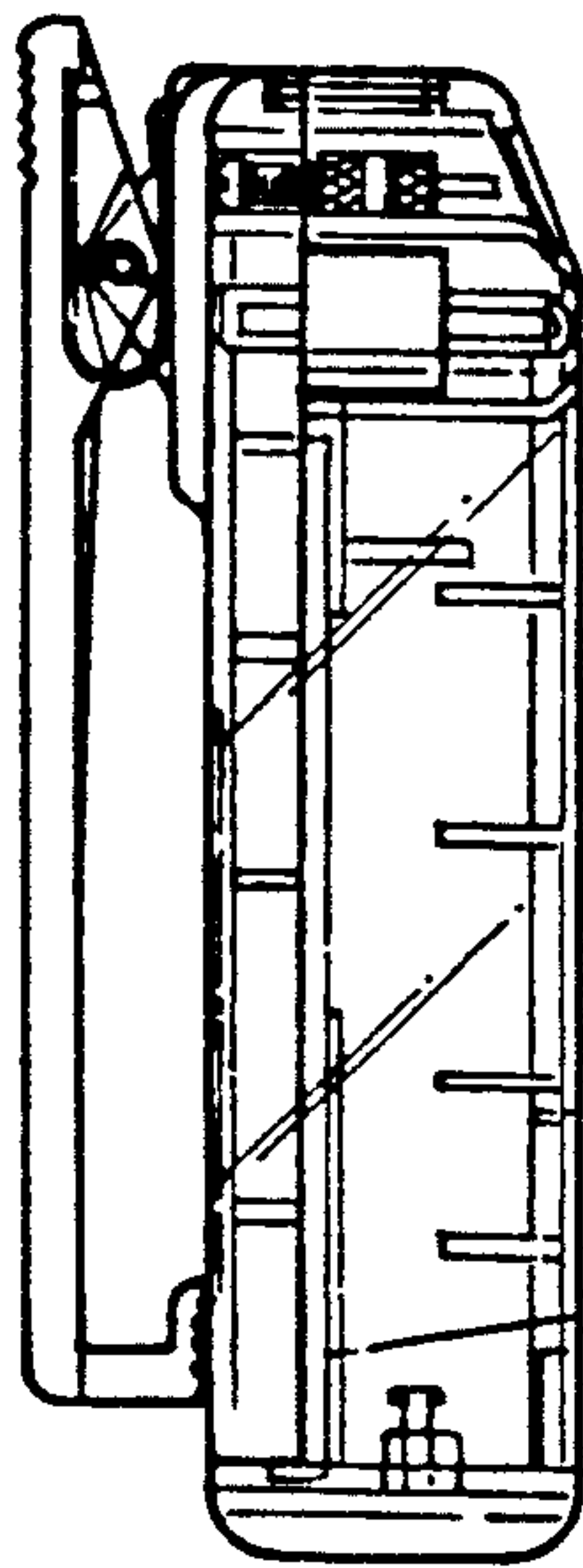

FIG 4

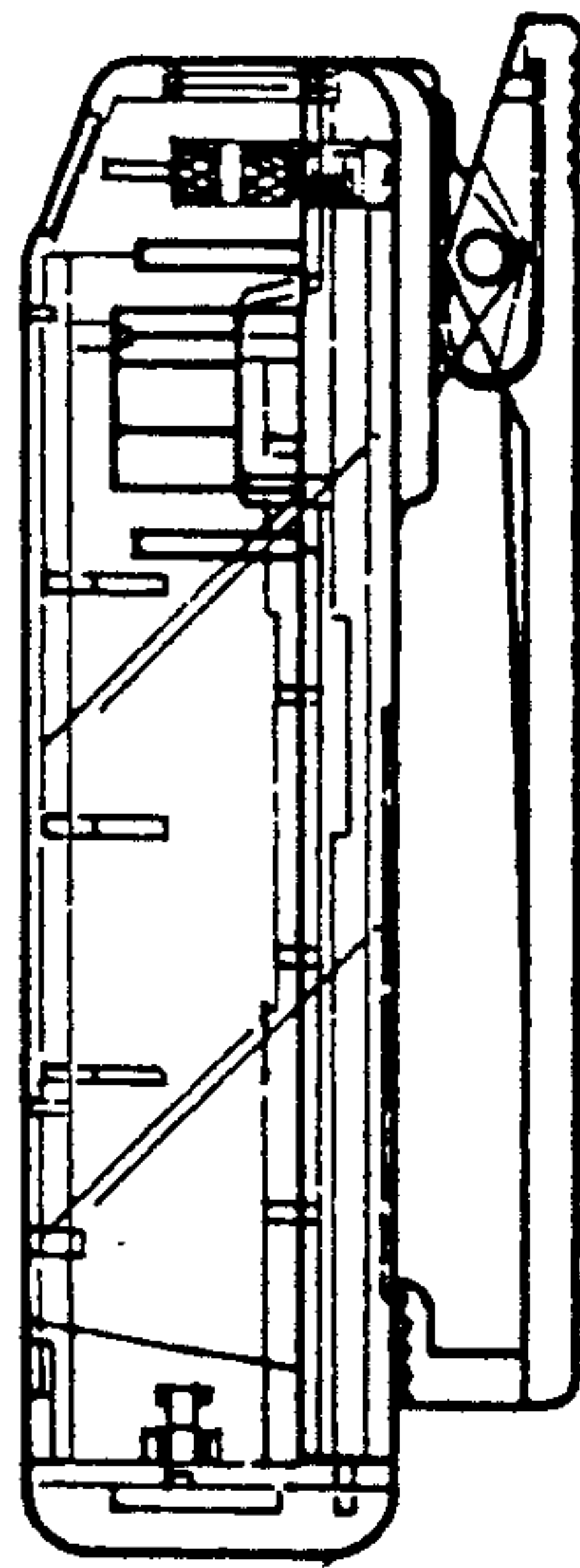

FIG 5

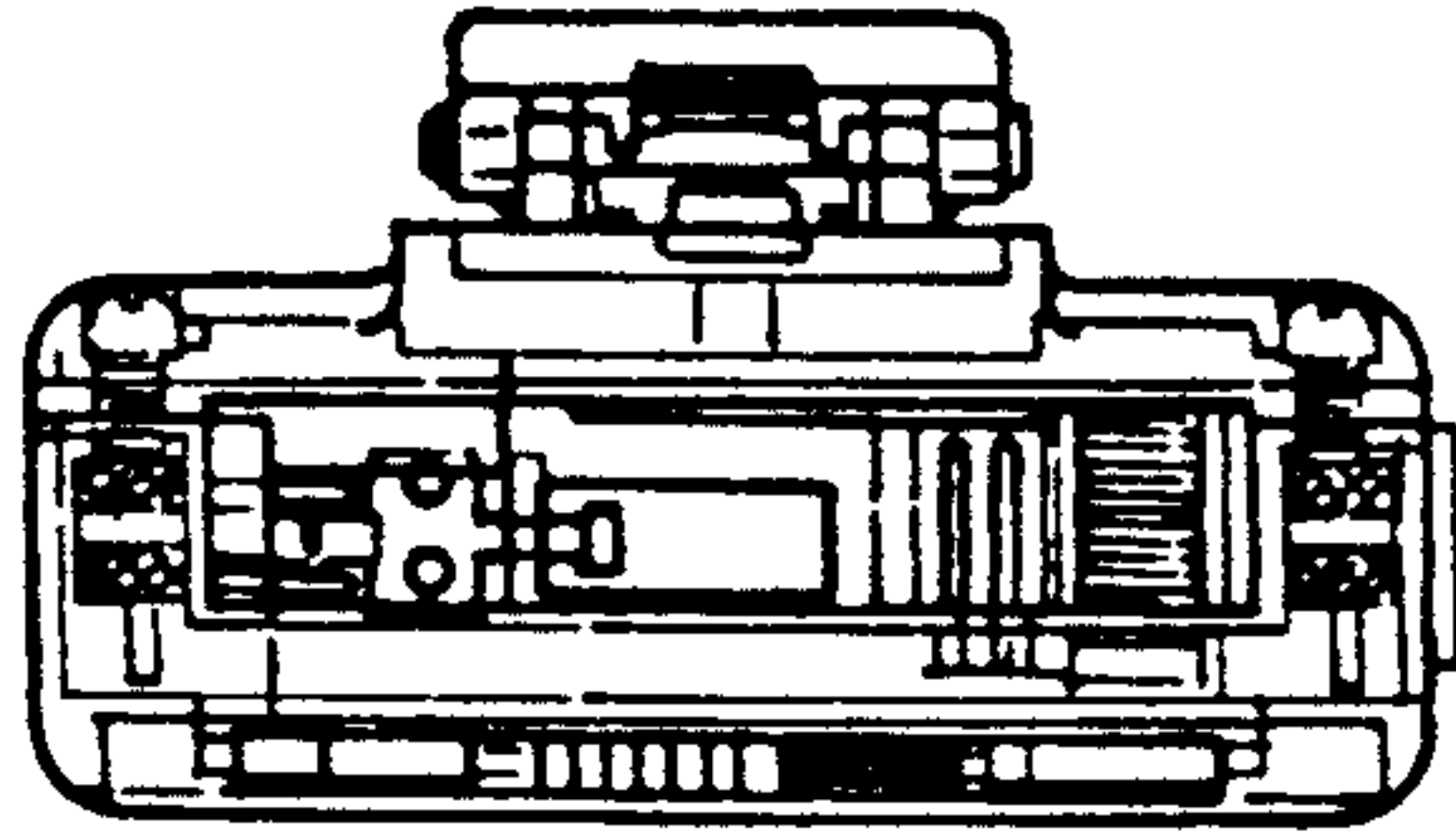

FIG 6

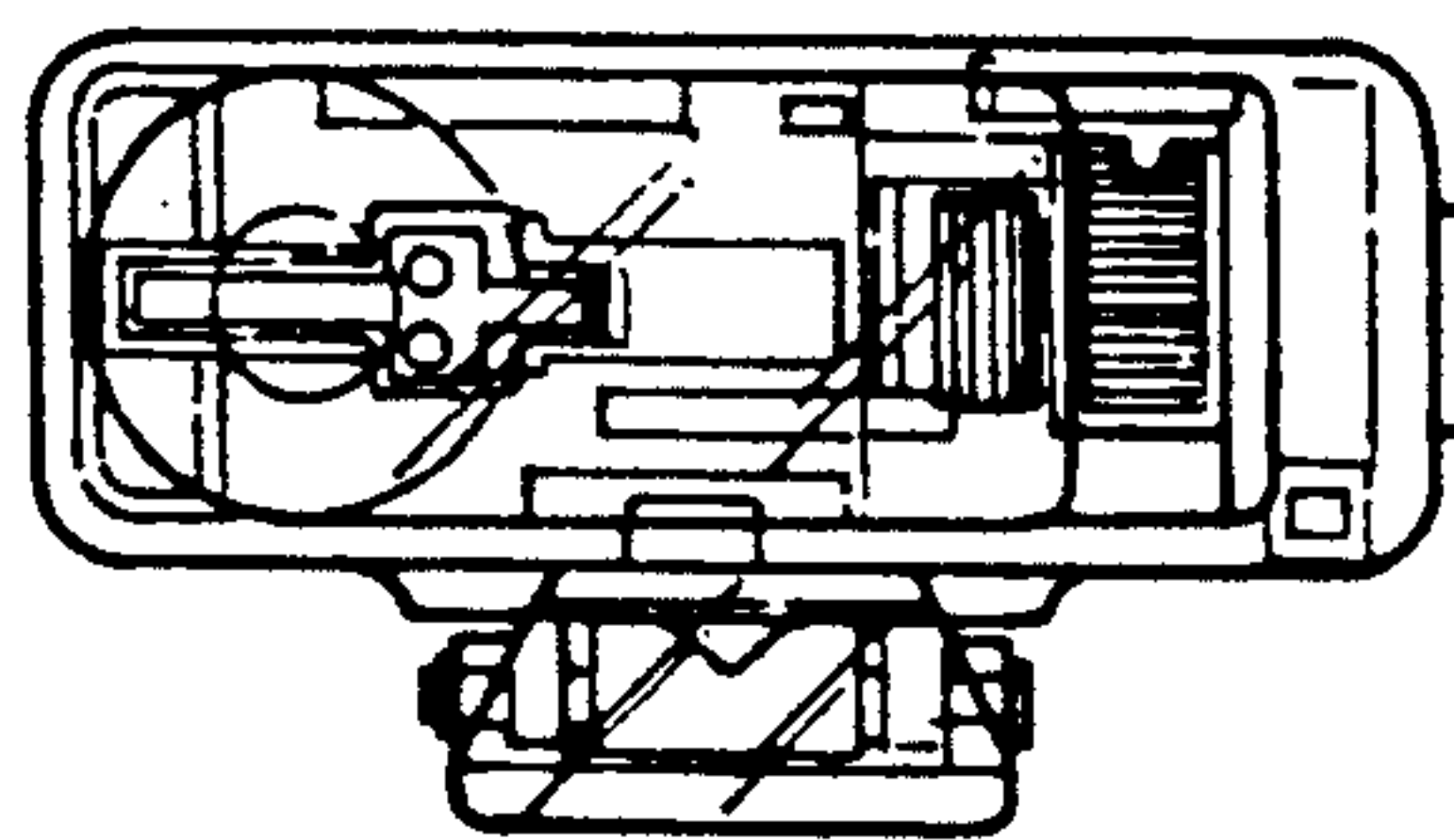

FIG 7