



US00D344064S

# United States Patent [19]

[11] Patent Number: Des. 344,064

Cirullo

[45] Date of Patent: \*\* Feb. 8, 1994

## [54] SAFETY PLUG

[76] Inventor: **Bernard A. Cirullo**, 26207 Edgemont Dr., Highland, Calif. 92346

[\*\*] Term: **14 Years**

[21] Appl. No.: **900,109**

[22] Filed: **Jun. 17, 1992**

[52] U.S. Cl. .... **D13/138**

[58] Field of Search ..... 439/135, 140, 141;  
D13/137, 138

## [56] References Cited

### U.S. PATENT DOCUMENTS

D. 326,642	6/1992	Lowe	.....	D13/138
3,631,320	12/1971	Eckert	.....	439/141 X
3,754,205	8/1973	Lenkey	.....	439/141
4,340,267	7/1982	Nukaga	.....	439/141
4,969,834	11/1990	Johnson	.....	439/141

## OTHER PUBLICATIONS

Symbols on p. 140 of Henry Dreyfuss Symbol Sourcebook ©1972, Located in Examiner Lucas' office.

*Primary Examiner*—Wallace R. Burke  
*Assistant Examiner*—Joel Sincavage  
*Attorney, Agent, or Firm*—S. Michael Bender

## [57] CLAIM

The ornamental design for a safety plug, as shown and described.

## DESCRIPTION

FIG. 1 is a front elevational view of the safety plug showing my new design;  
FIG. 2 is a rear elevational view thereof;  
FIG. 3 is a left side elevational view thereof;  
FIG. 4 is a right side elevational view thereof;  
FIG. 5 is a top plan view thereof;  
FIG. 6 is a bottom plan view thereof; and,  
FIG. 7 is an isometric view thereof.

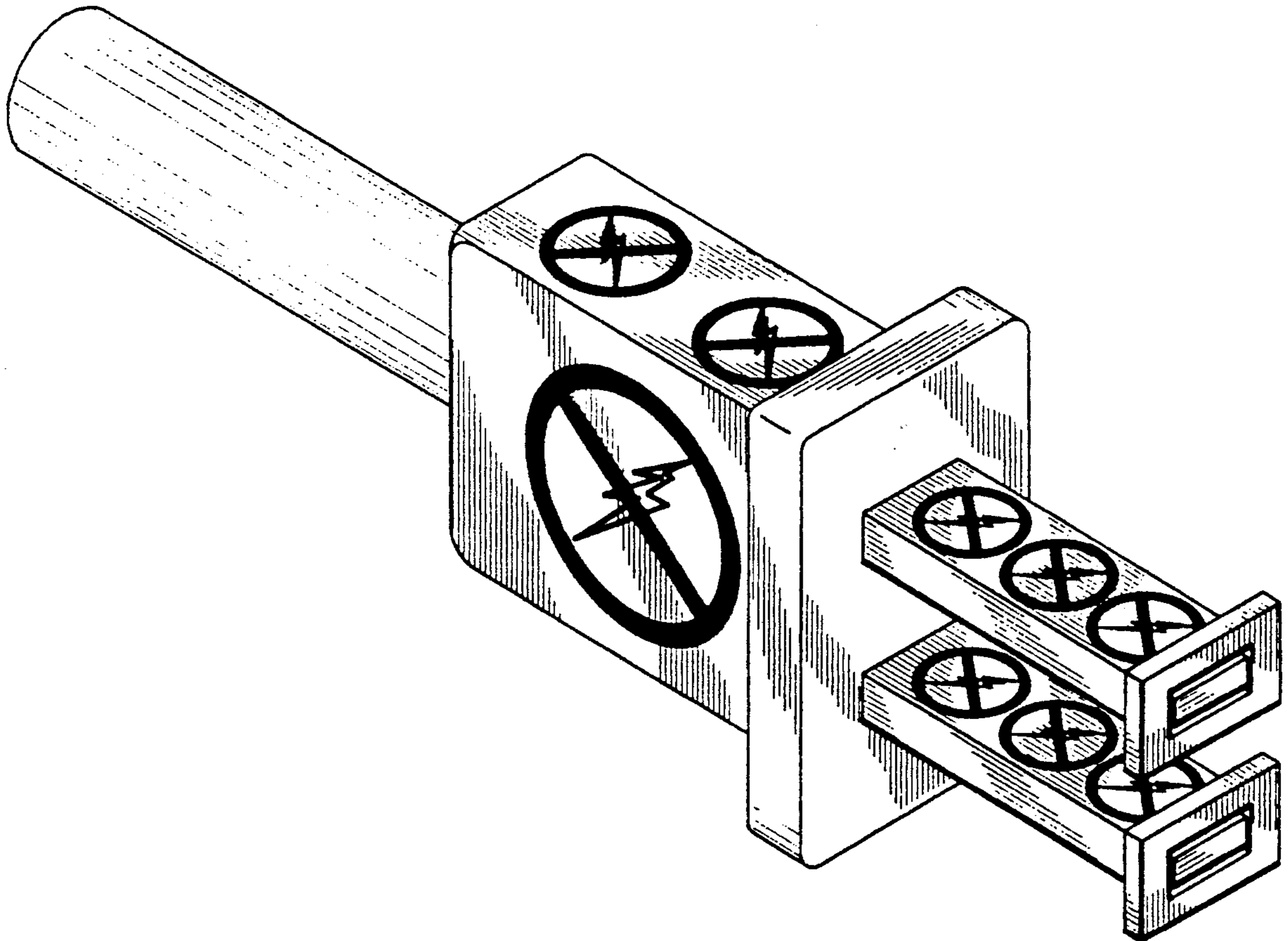

FIG. 1

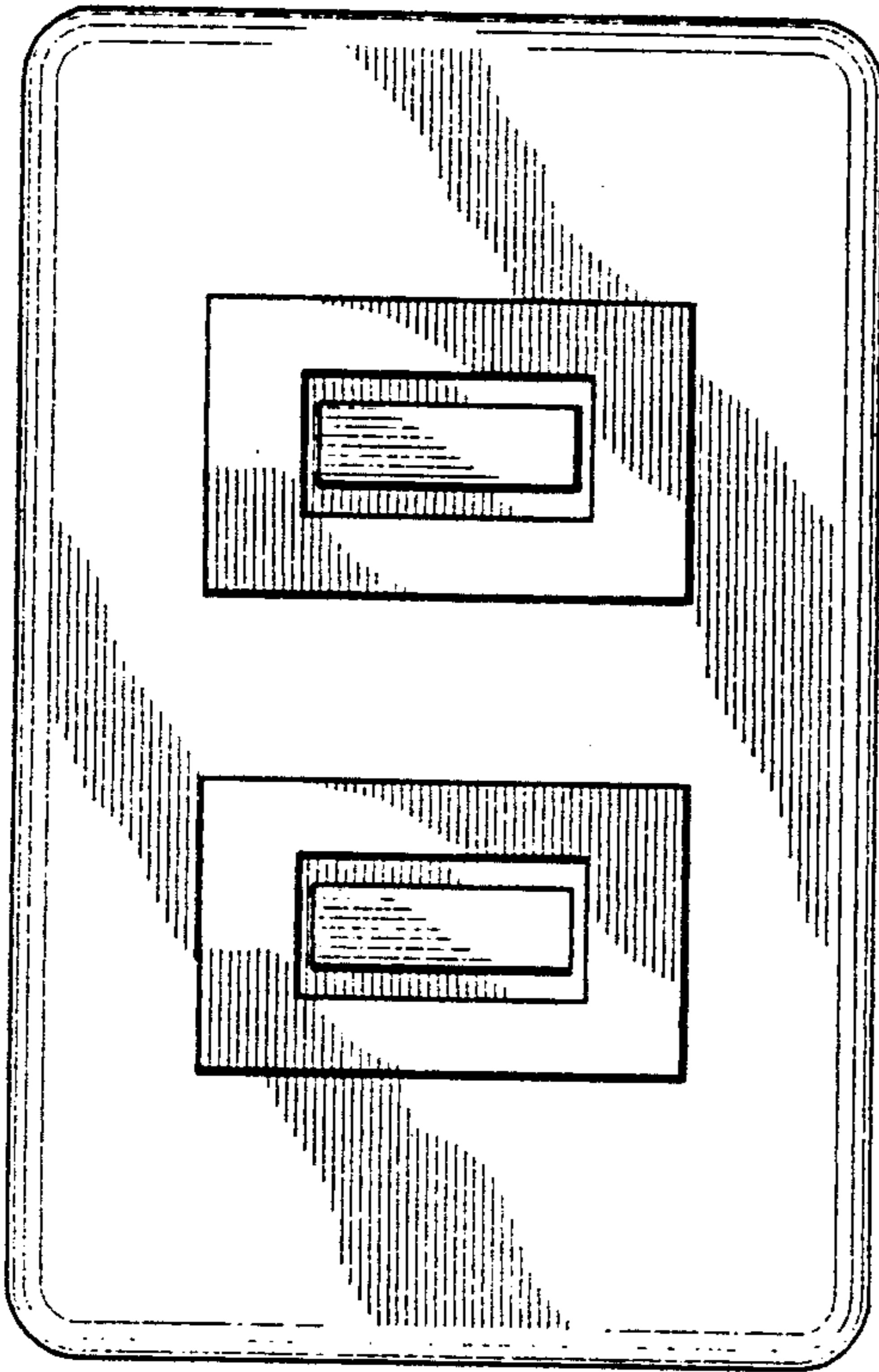

FIG. 2

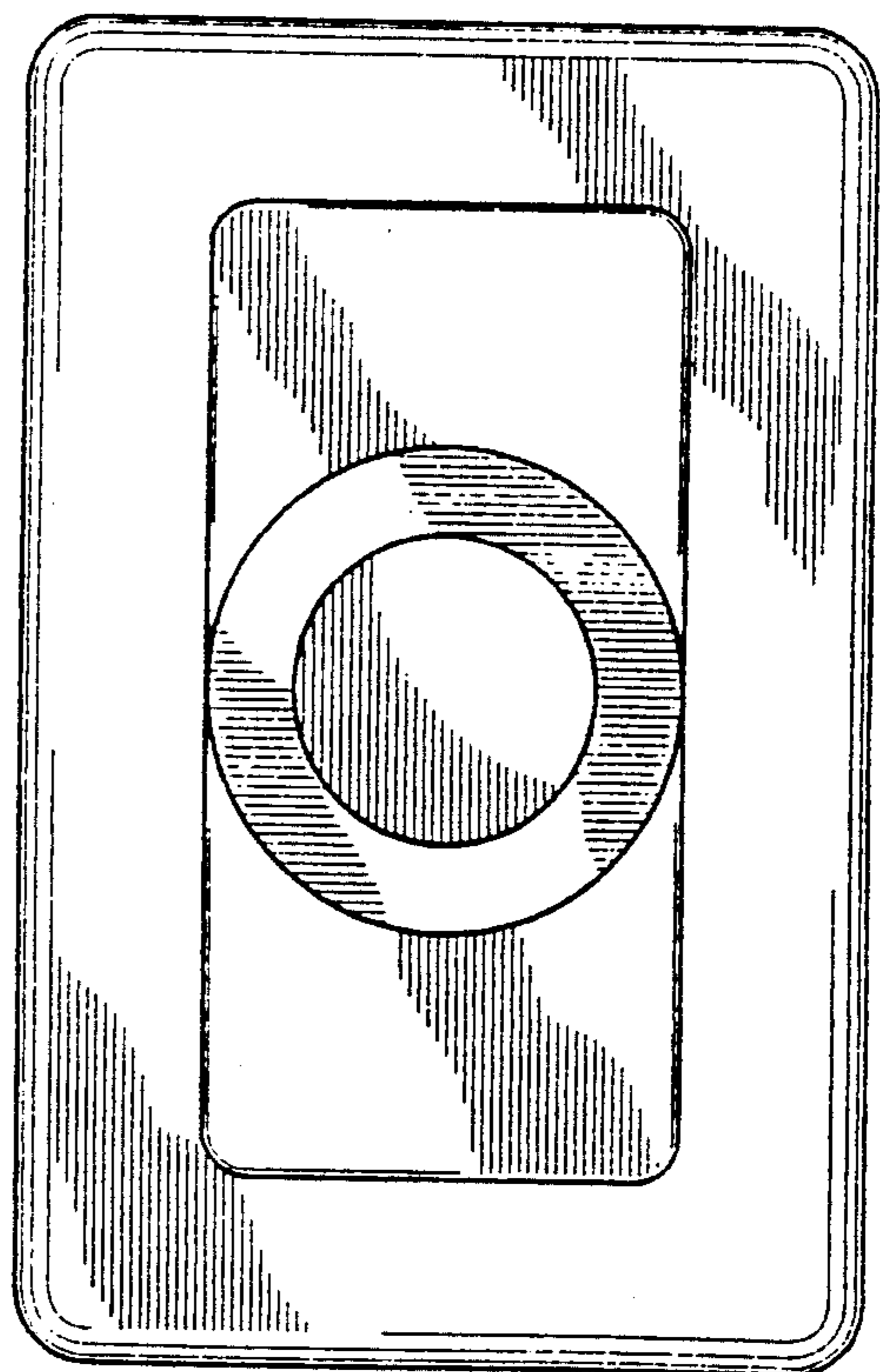

FIG. 3

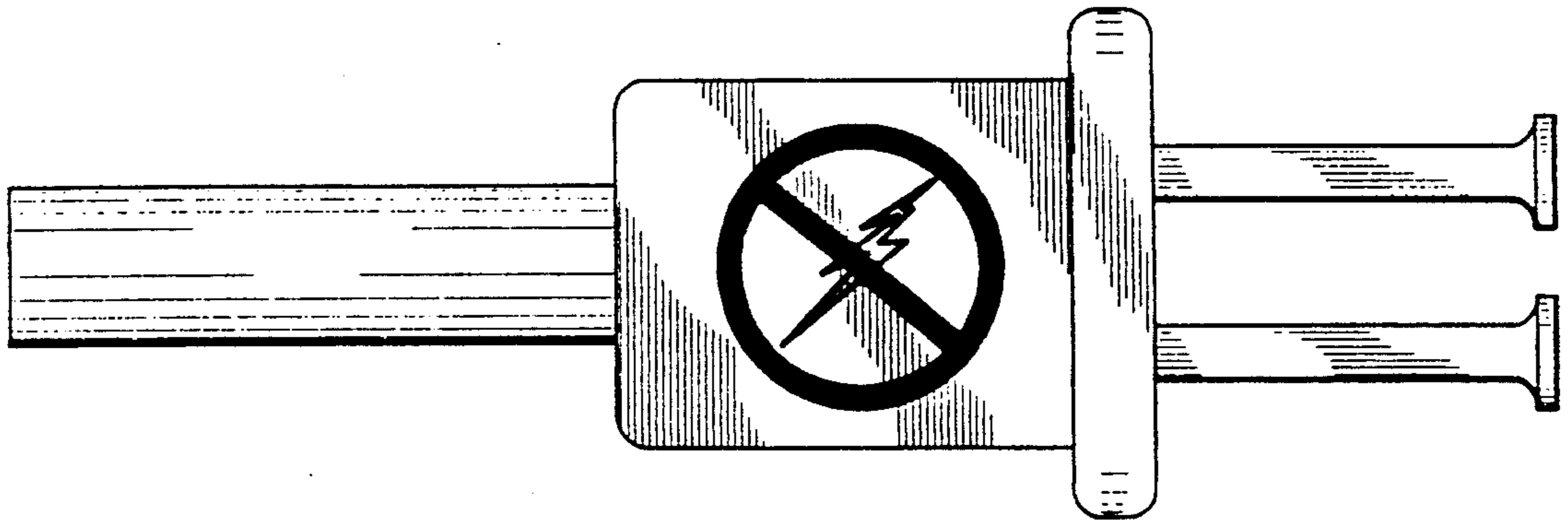

FIG. 4

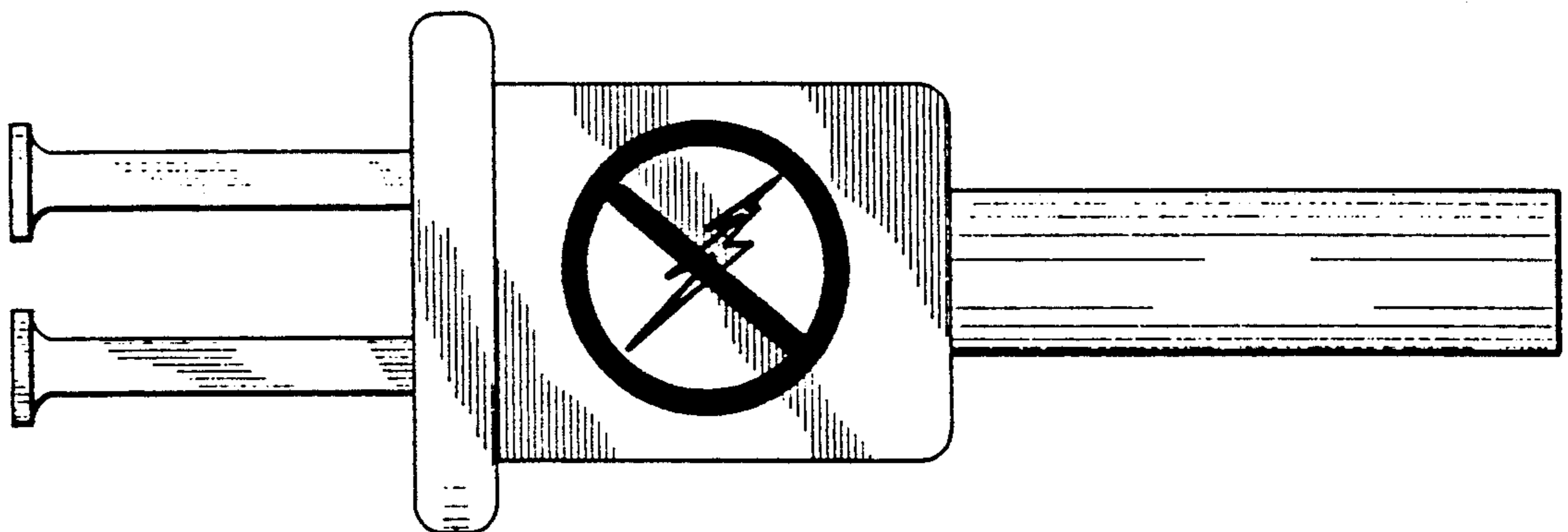

FIG. 5

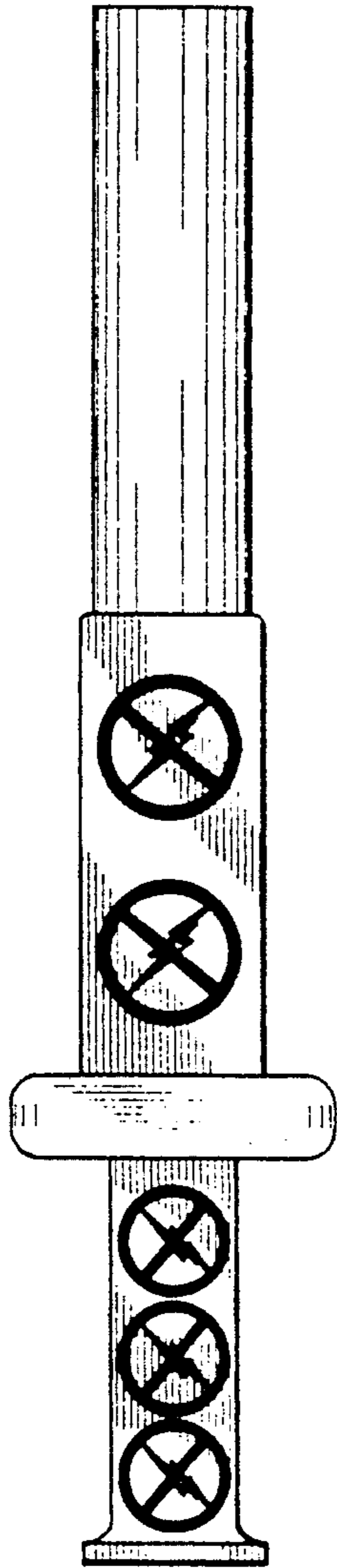

FIG. 6

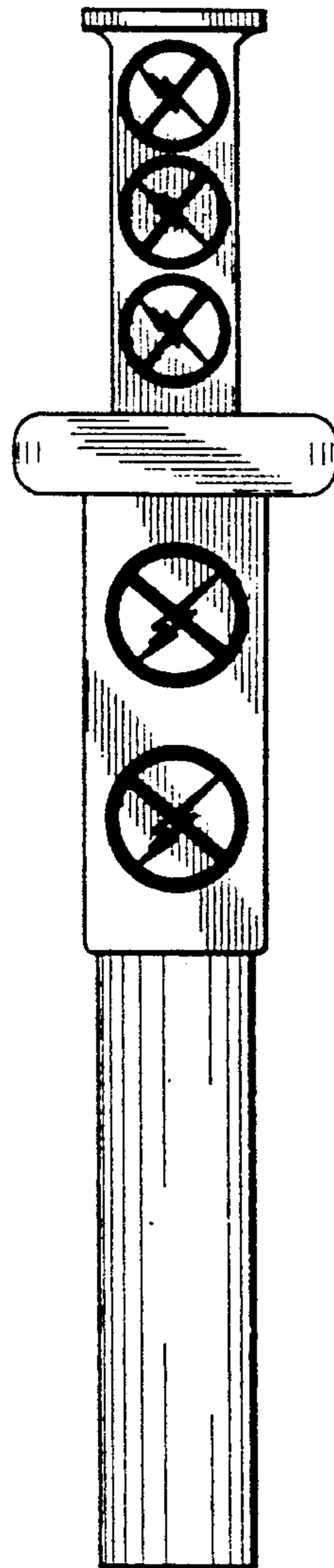

FIG. 7

