



US00D343975S

# United States Patent [19]

[11] Patent Number: **Des. 343,975**

Penalver, Jr.

[45] Date of Patent: **\*\* Feb. 8, 1994**

## [54] ROOM AND SHOP ORGANIZER

[76] Inventor: **John Penalver, Jr.**, 138-06 234th St., Laurelton, N.Y. 11422

[\*\*] Term: **14 Years**

[21] Appl. No.: **802,458**

[22] Filed: **Dec. 5, 1991**

[52] U.S. Cl. .... **D6/567**

[58] Field of Search ..... **D6/553, 556, 567**

### [56] References Cited

#### U.S. PATENT DOCUMENTS

D. 280,263	8/1985	Hoye	.....	D6/556
D. 290,314	6/1987	Lieban	.....	D6/553 X
D. 328,216	7/1992	Steed	.....	D6/567
2,754,078	7/1956	Koger et al.	.....	248/371.2
4,219,178	8/1980	Assion	.....	211/89

*Primary Examiner*—Brian N. Vinson  
*Attorney, Agent, or Firm*—Terry M. Gernstein

### [57] CLAIM

The ornamental design for a room and shop organizer, as shown and described.

### DESCRIPTION .

FIG. 1 is an exploded perspective view of the room and shop organizer embodying the design of the present invention;

FIG. 2 is an assembled side elevational view thereof, the side opposite being a mirror image of the side shown in FIG. 2;

FIG. 3 is a rear elevational view thereof;

FIG. 4 is a front elevational view thereof;

FIG. 5 is a top plan view thereof; and,

FIG. 6 is a bottom view thereof.

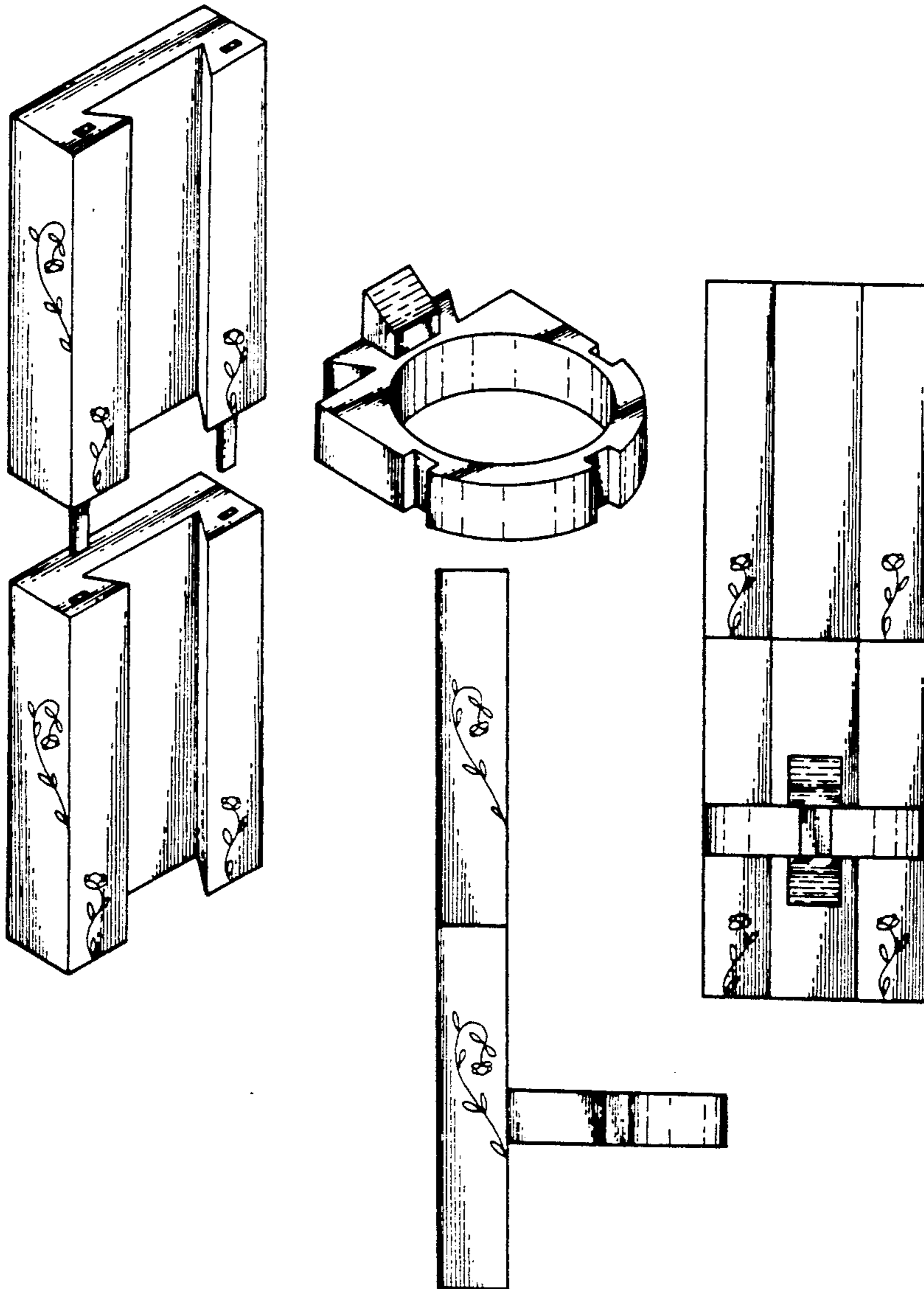

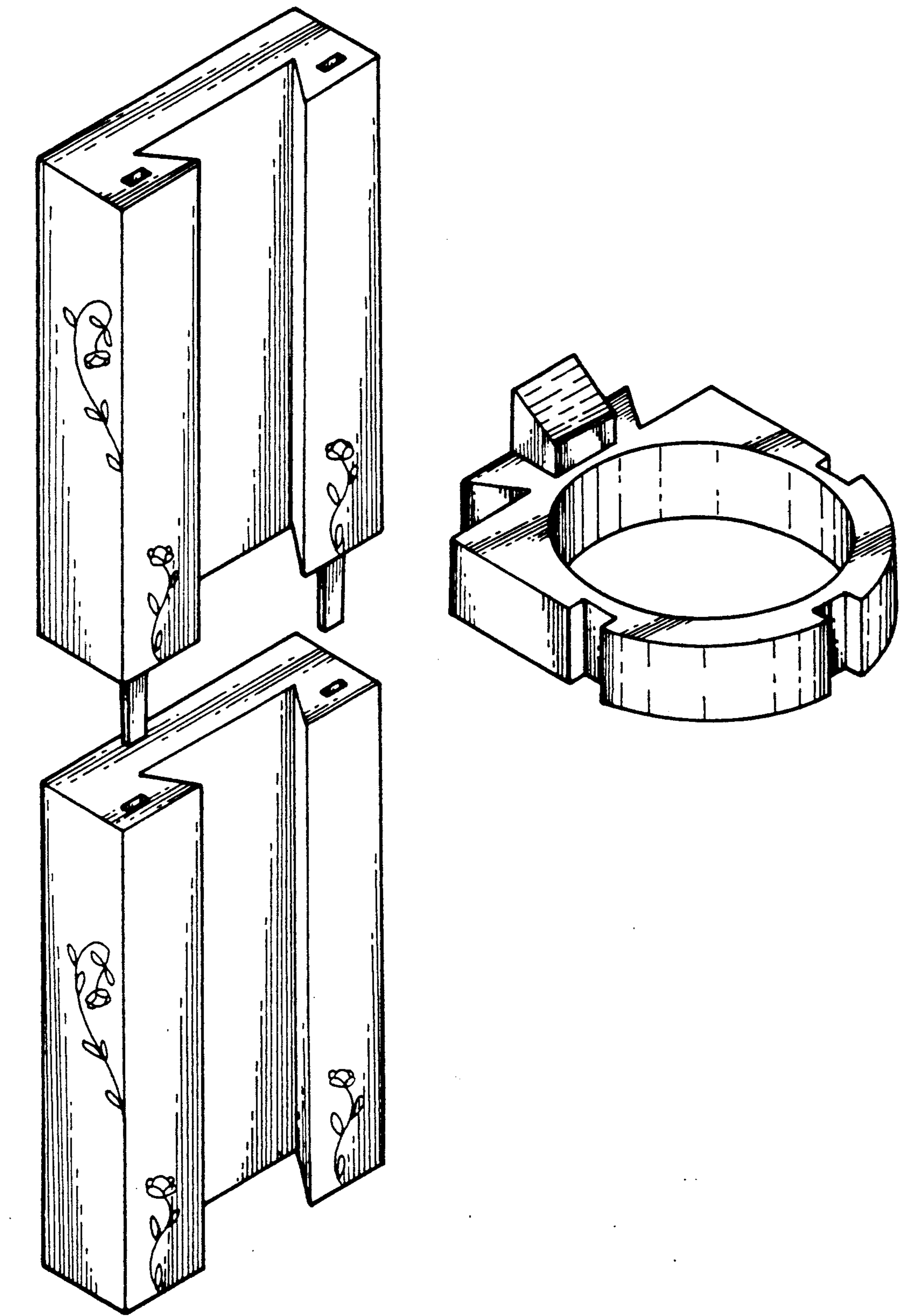

FIG. 1

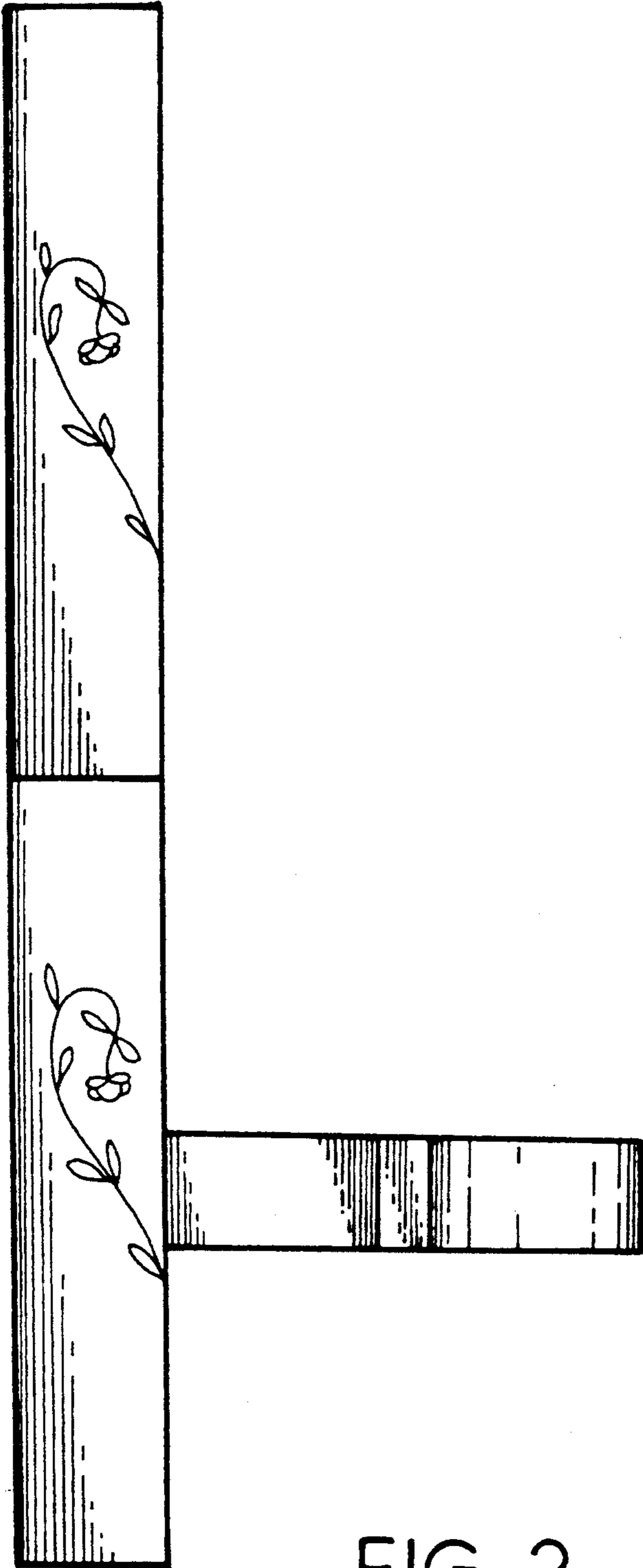

FIG. 2

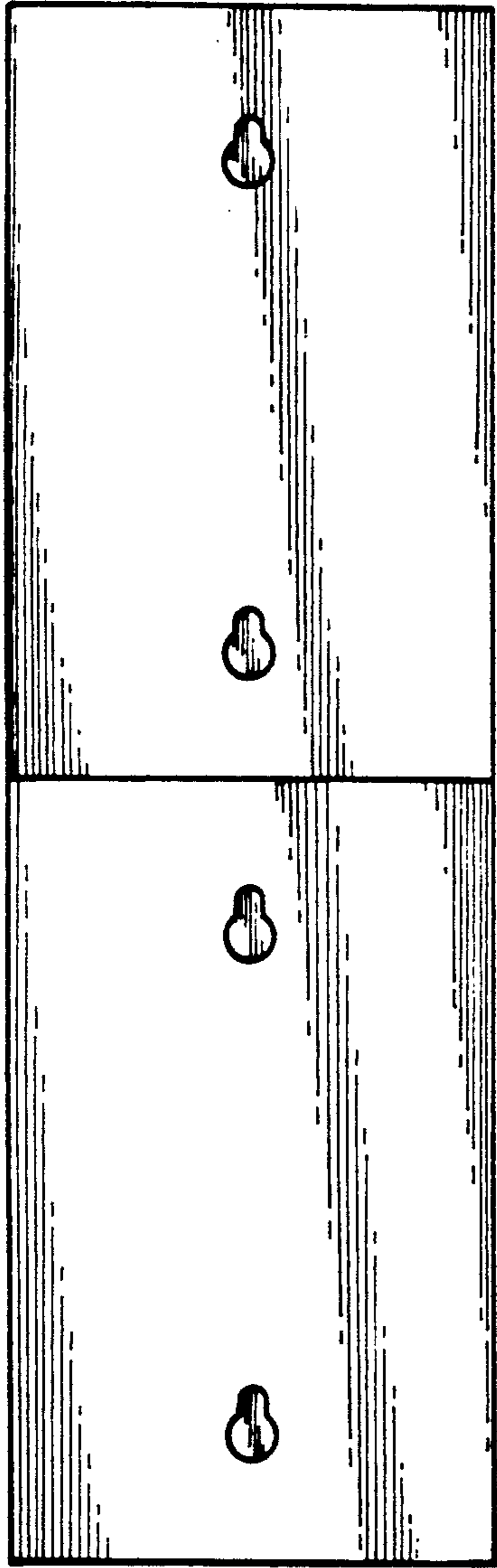

FIG. 3

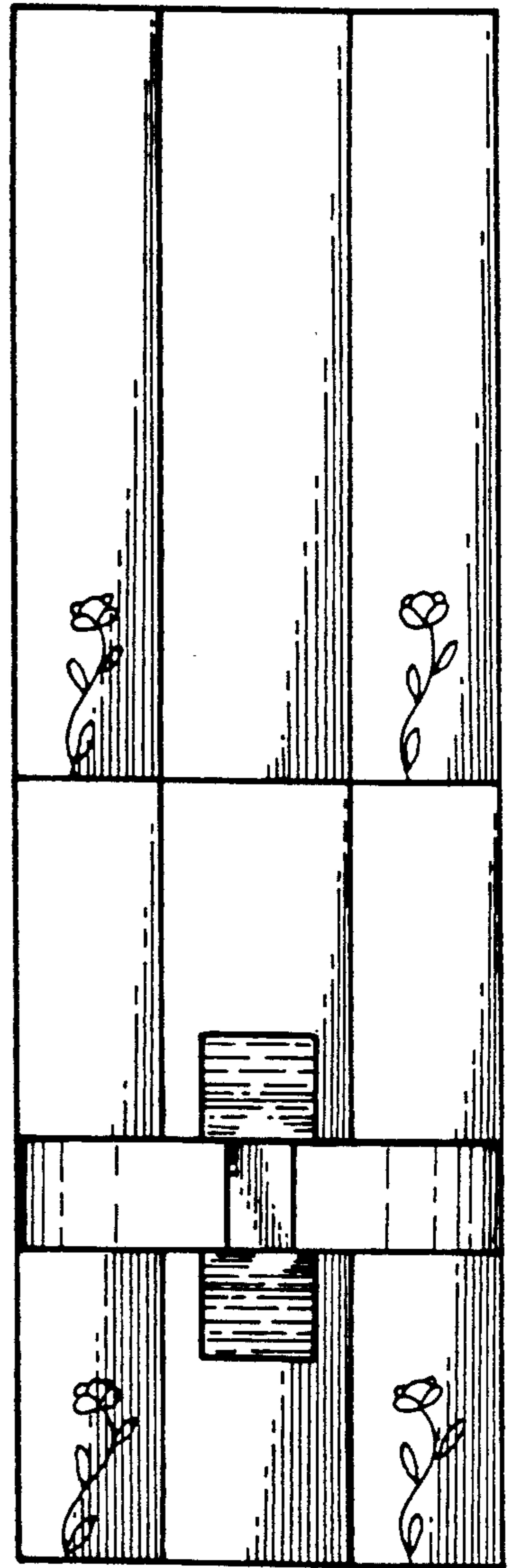

FIG. 4

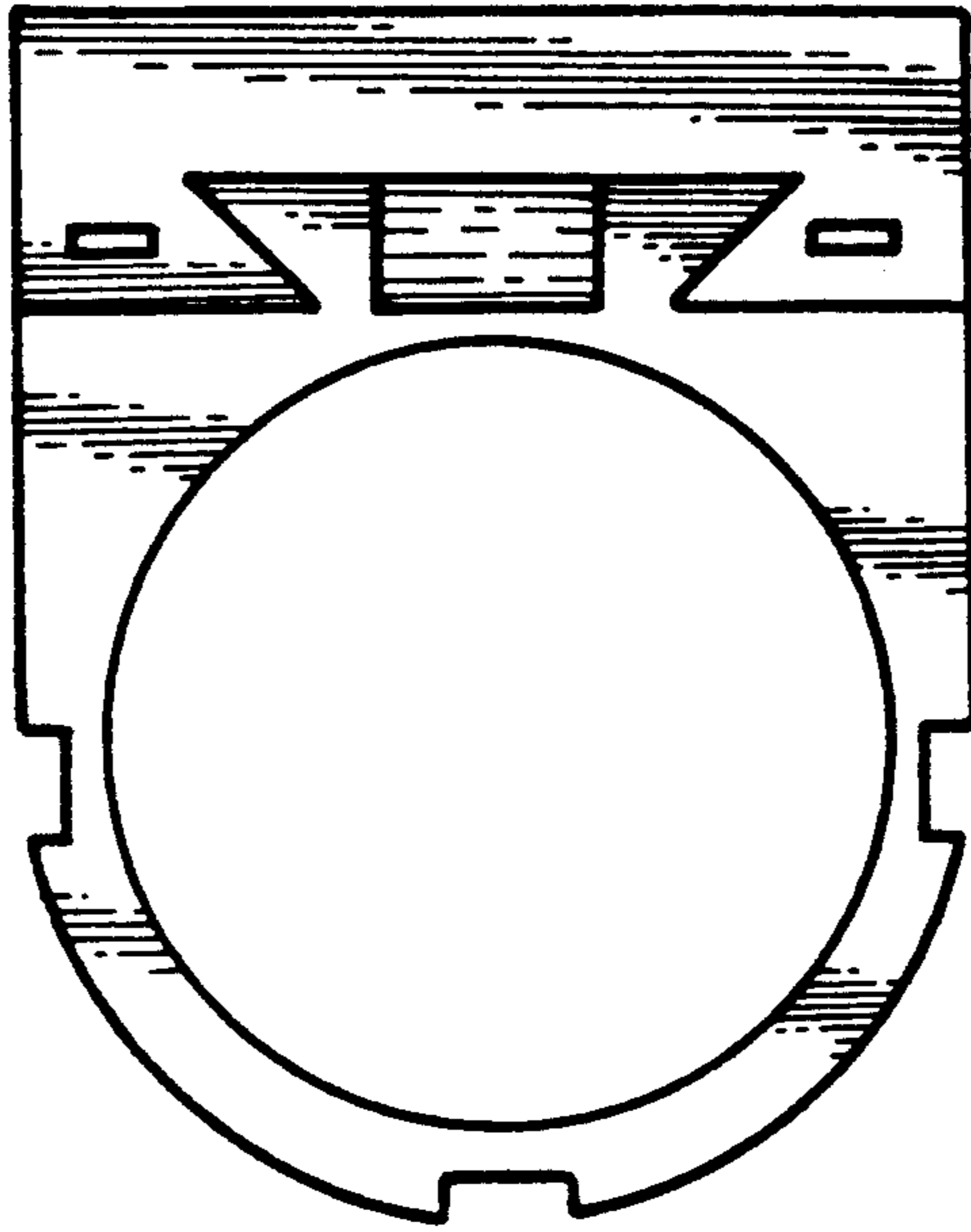

FIG. 5

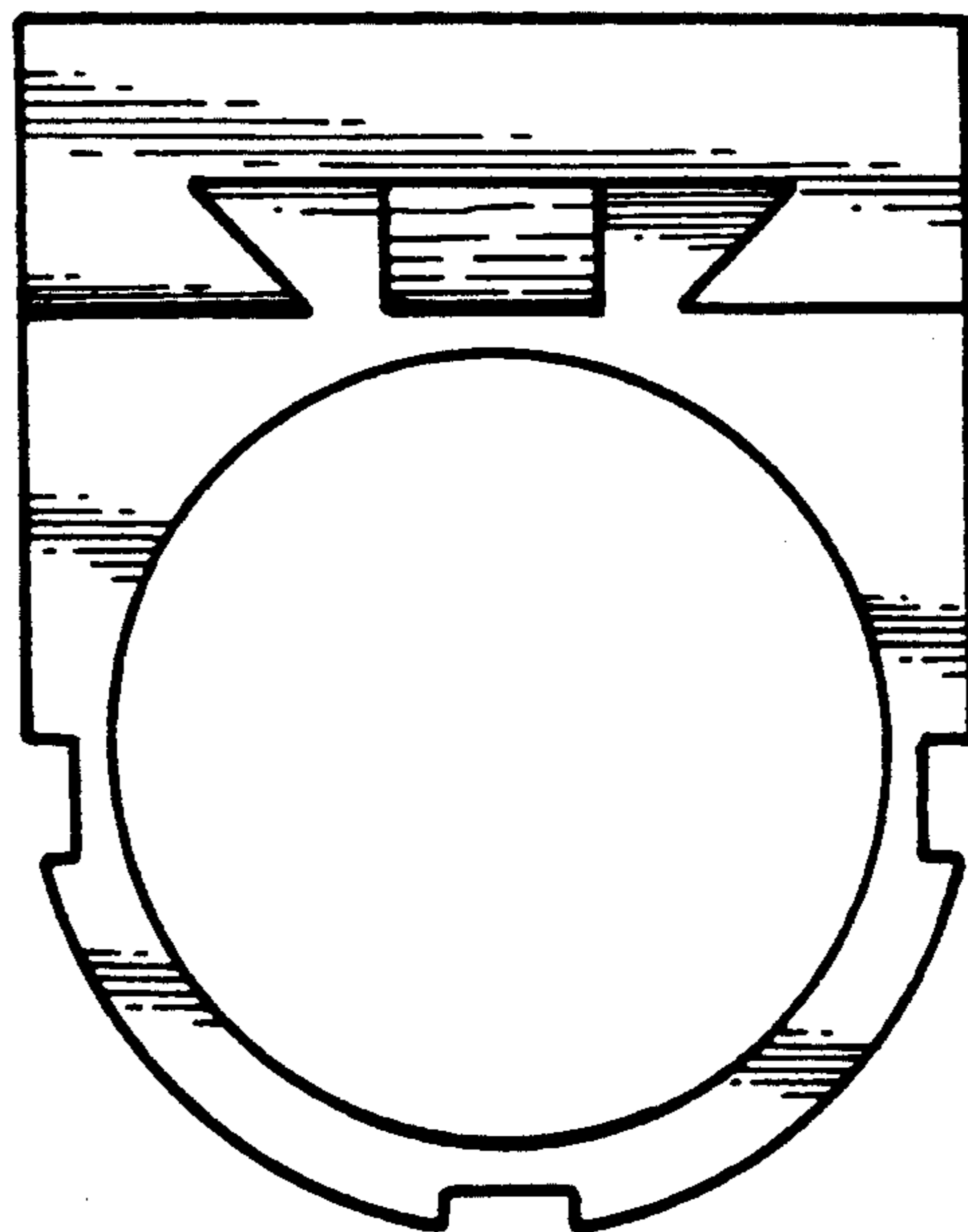

FIG. 6