



US00D343972S

United States Patent [19]

[11] Patent Number: Des. 343,972

Pauer et al.

[45] Date of Patent: ** Feb. 8, 1994

[54] TABLE

[75] Inventors: Jericho P. Pauer, Onalaska, Wis.;
Randy Peterson, Winona, Minn.

[73] Assignee: Ashley Furniture Industries, Inc.,
Arcadia, Wis.

[**] Term: 14 Years

[21] Appl. No.: 883,412

[22] Filed: May 14, 1992

[52] U.S. Cl. D6/480; D6/451

[58] Field of Search D6/480, 482-489,
D6/495-496, 450, 451; 108/150, 161, 163

[56] References Cited

U.S. PATENT DOCUMENTS

- D. 205,387 7/1966 Fisher D6/450
- D. 238,840 2/1976 Cassina D6/483 X
- D. 306,107 2/1990 Grosfillex D6/480

OTHER PUBLICATIONS

- D.I.A. Catalog ©1983, p. 23, top left, table 397.
- D.I.A. Cat. ©1983, p. 14, top right, table #628-5.
- Furniture Today*, Apr. 10, 1989, p. 191, table in center.

Primary Examiner—Nelson C. Holtje
Assistant Examiner—J. E. Seeger
Attorney, Agent, or Firm—Peterson, Wicks, Nemer & Kamrath

[57] CLAIM

The ornamental design for table, as shown and described.

DESCRIPTION

FIG. 1 is a perspective of a cocktail table embodying our new design;
 FIG. 2 is a top plan thereof;
 FIG. 3 is a front elevation thereof, with the rear elevation thereof being a mirror image thereof;
 FIG. 4 is an end elevation thereof, with the opposite end elevation thereof being a mirror image thereof;
 FIG. 5 is a perspective of an end table embodying another modified form of our new design;
 FIG. 6 is a top plan of the table shown in FIG. 5;
 FIG. 7 is a front elevation of the table shown in FIG. 5, with the rear elevation thereof being a mirror image thereof; and,
 FIG. 8 is an end elevation of the table shown in FIG. 5, with the opposite end elevation thereof being a mirror image thereof.

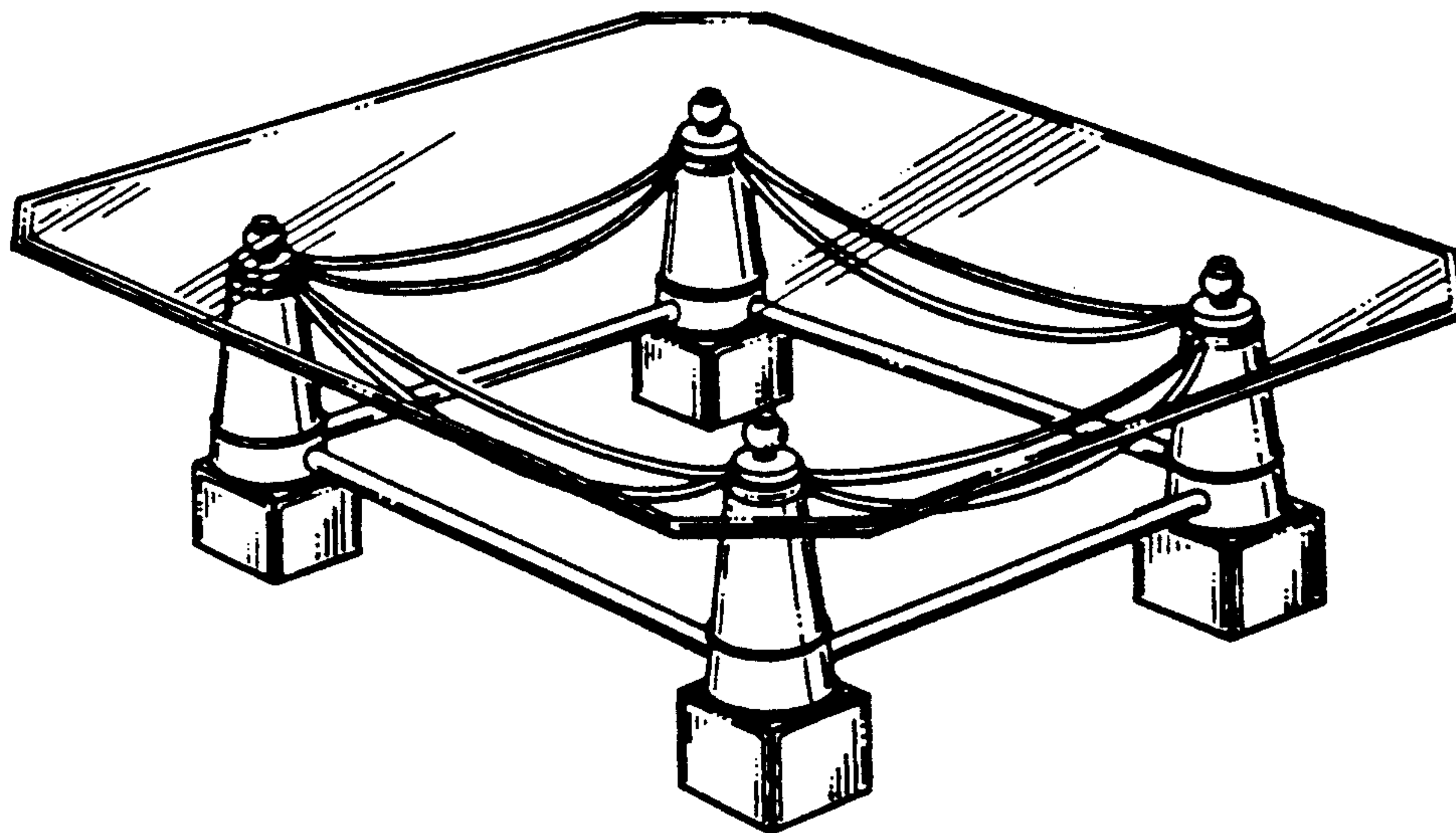

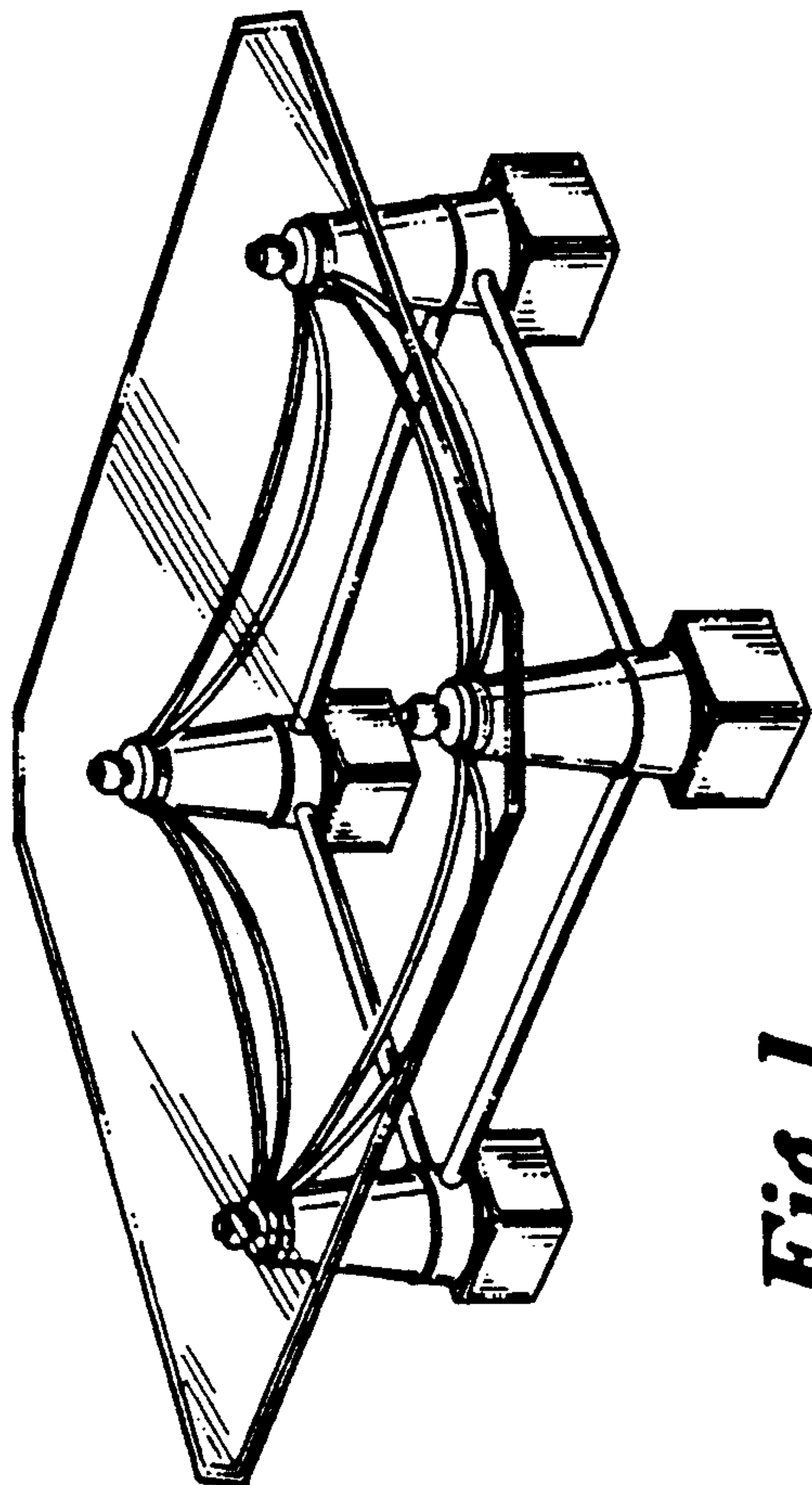

Fig. 1

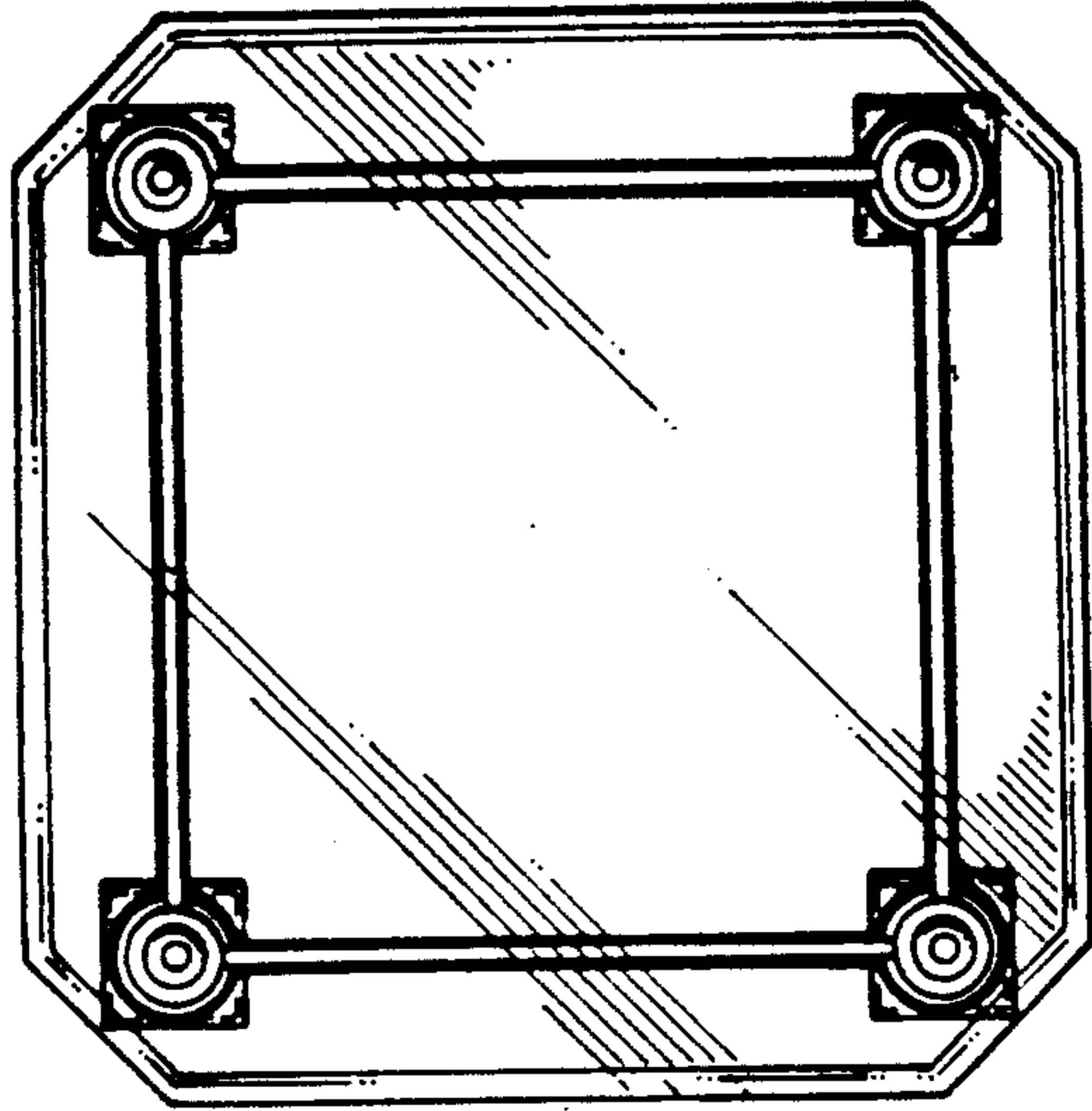

Fig. 2

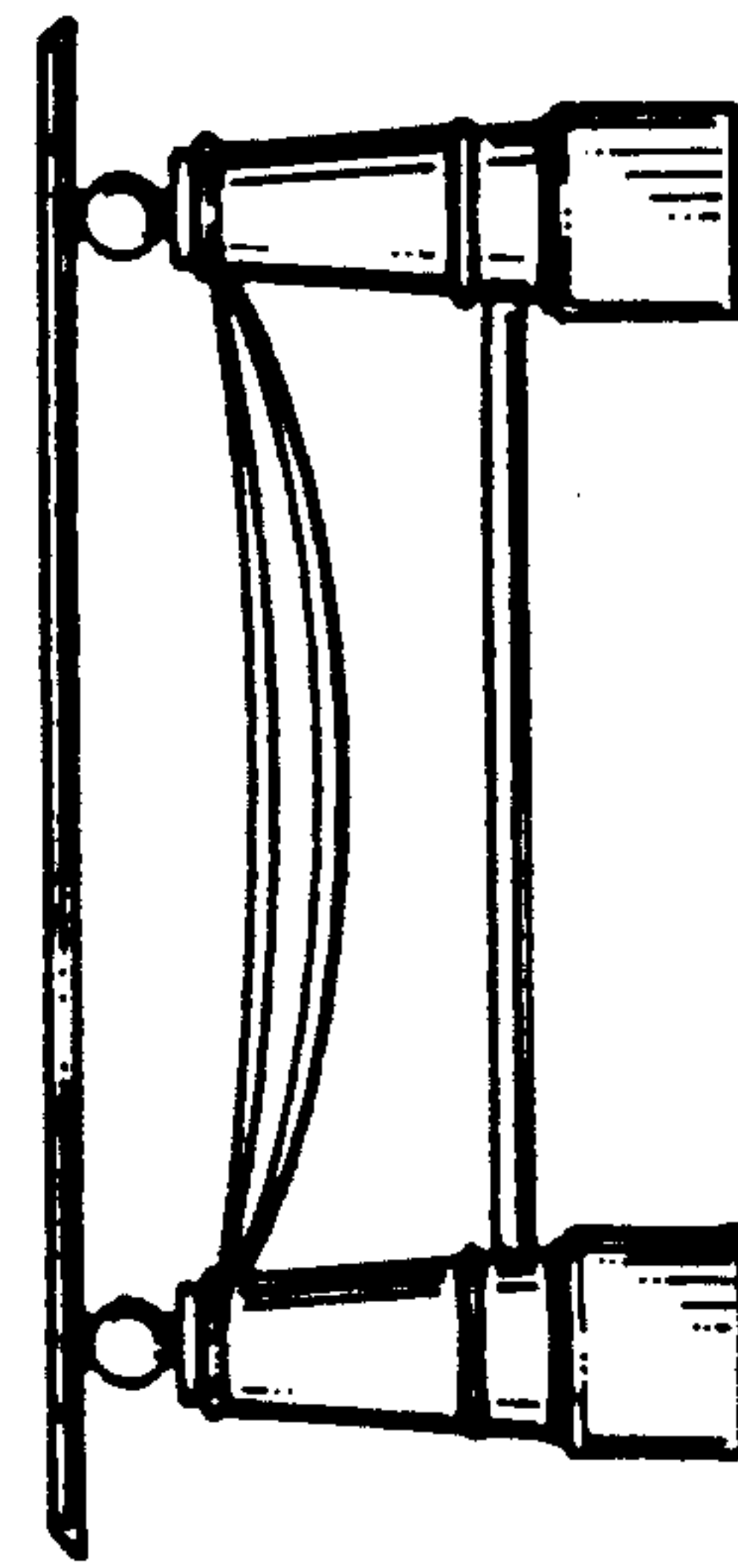

Fig. 3

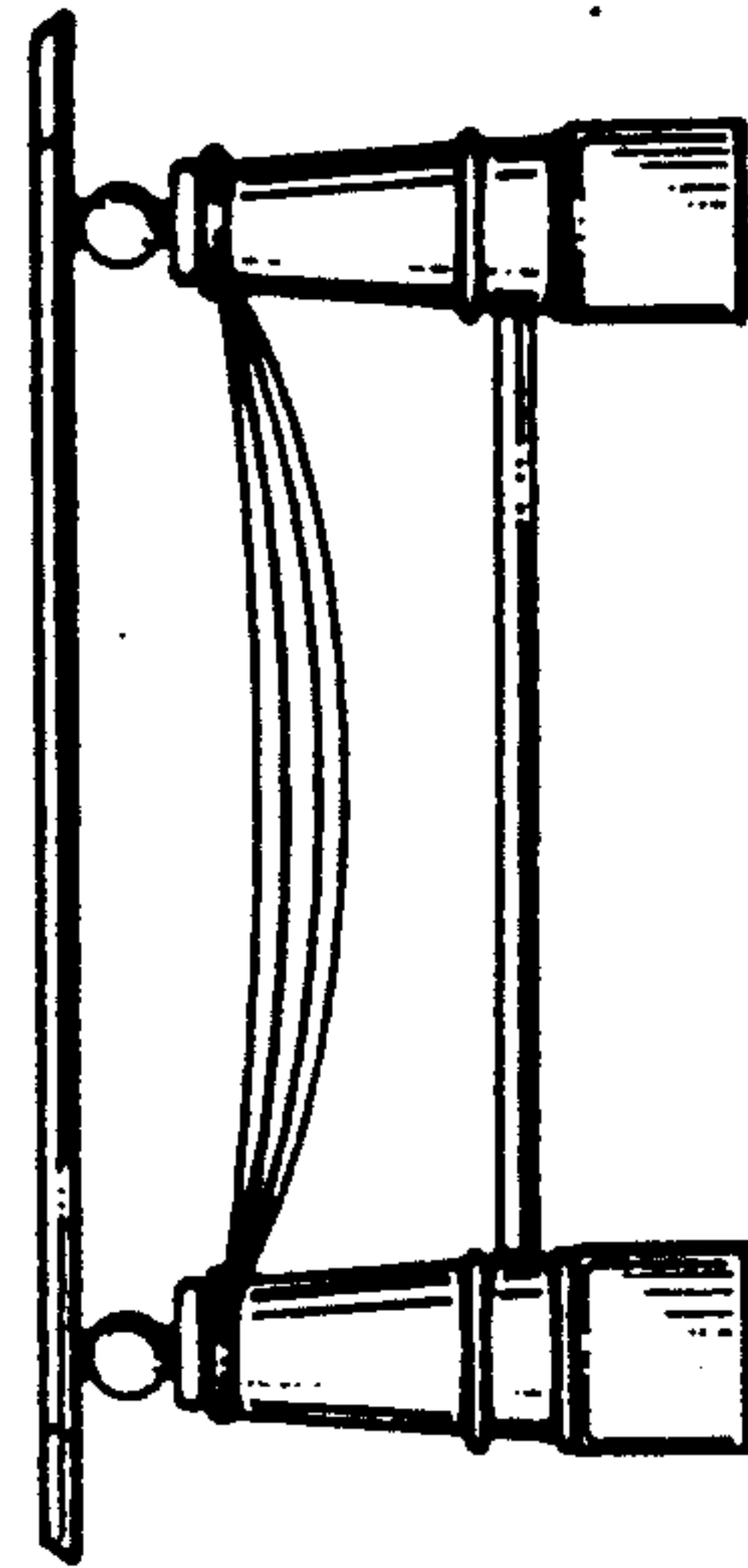

Fig. 4

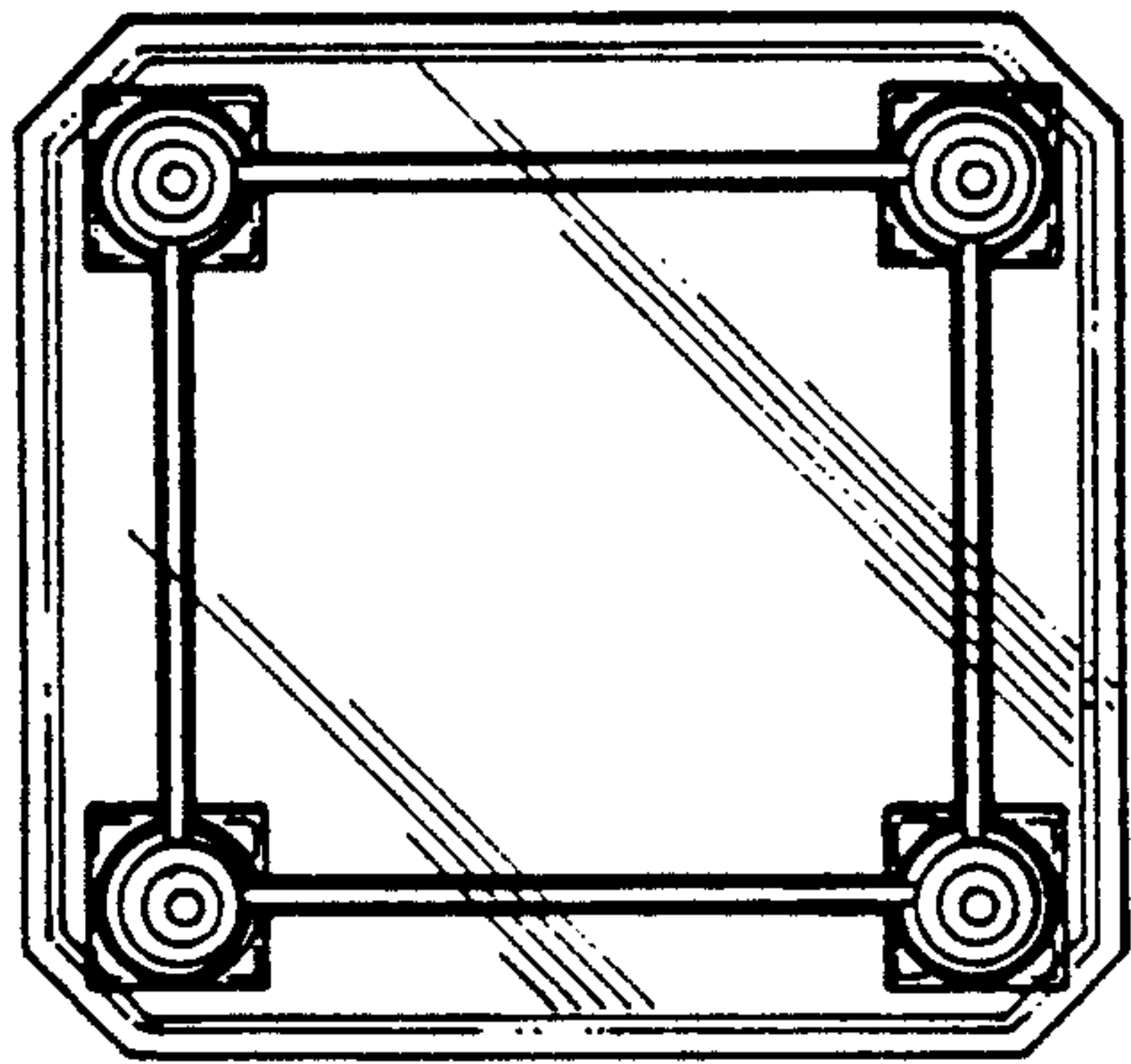

Fig. 6

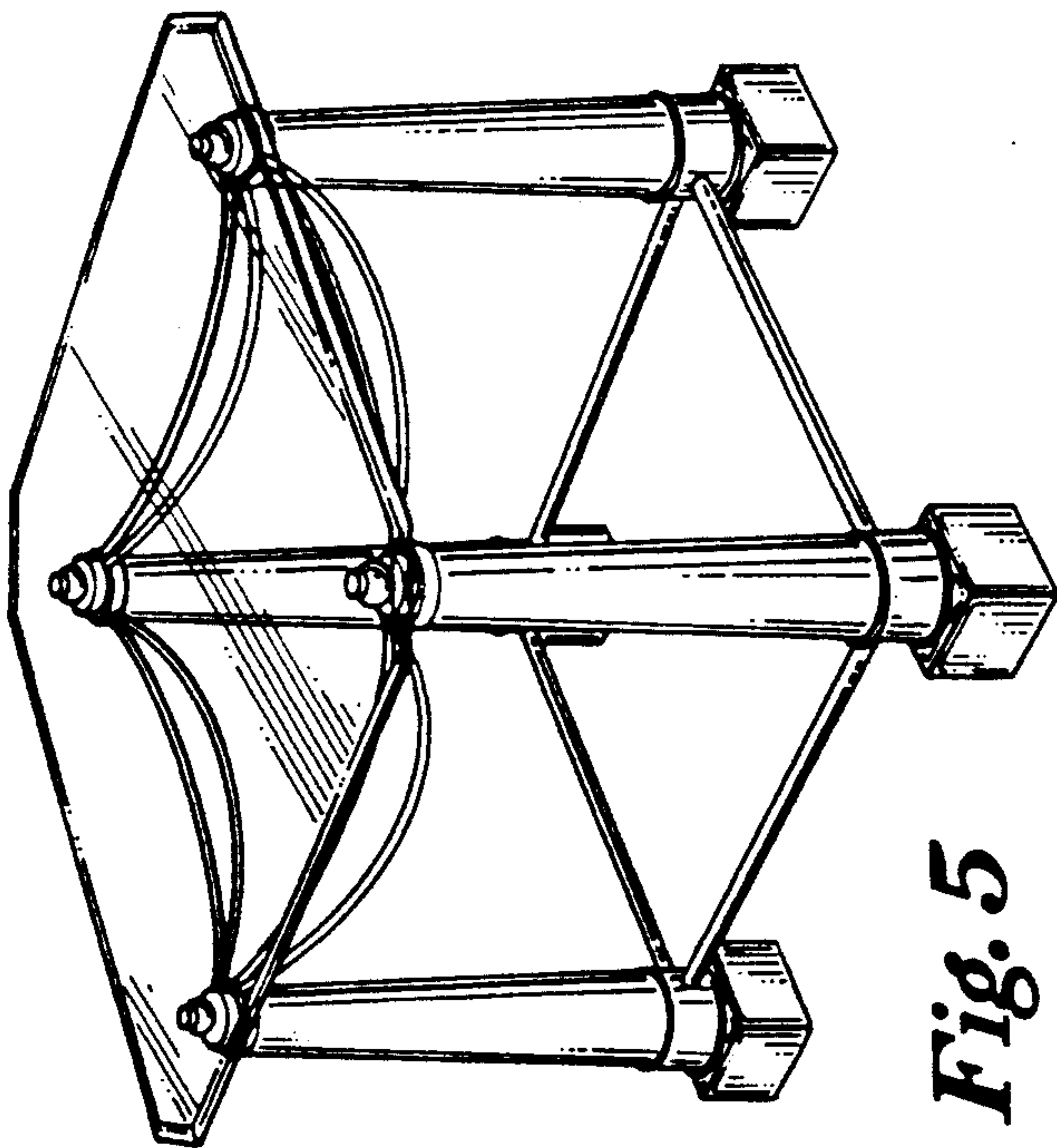

Fig. 5

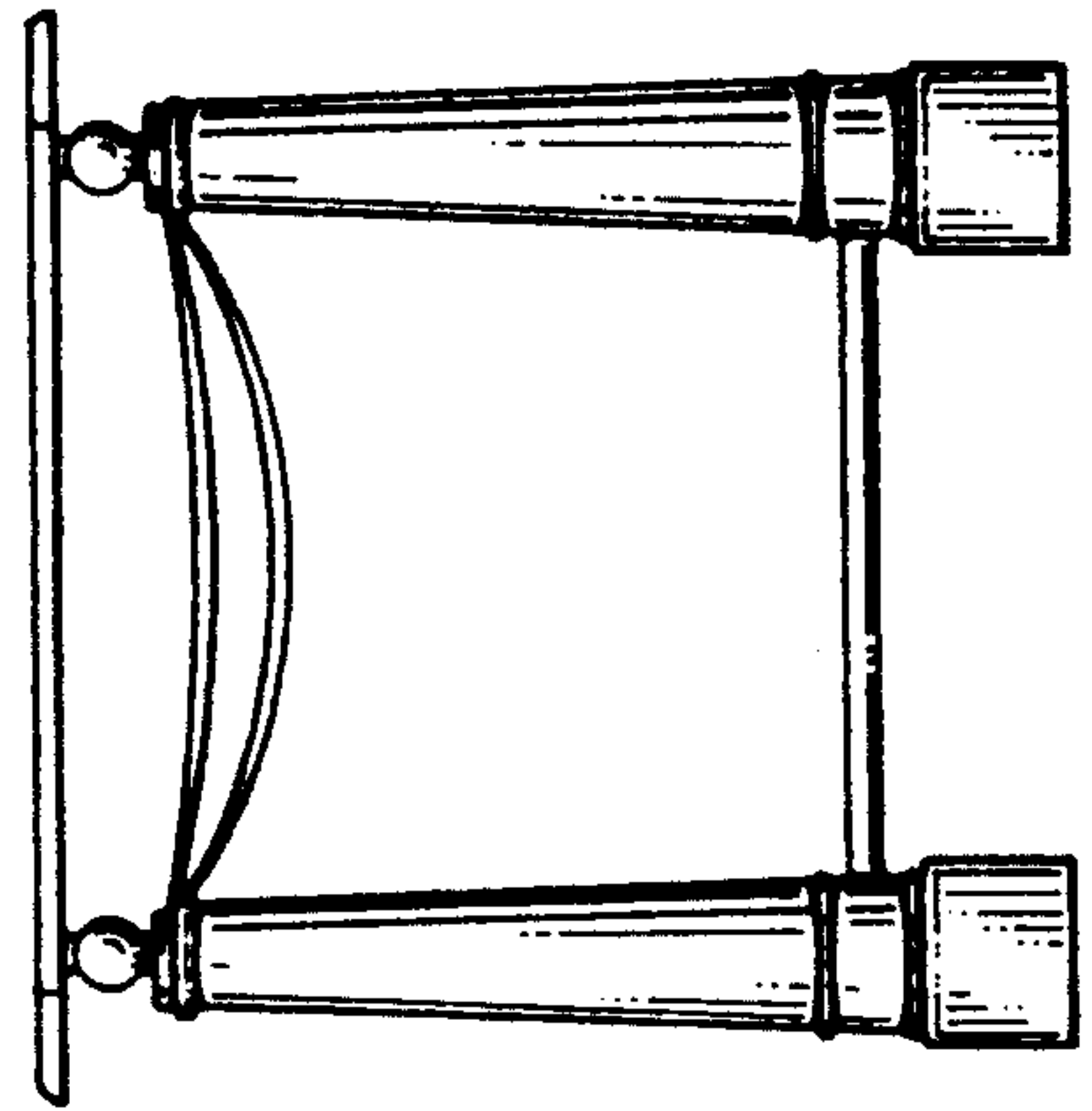

Fig. 8

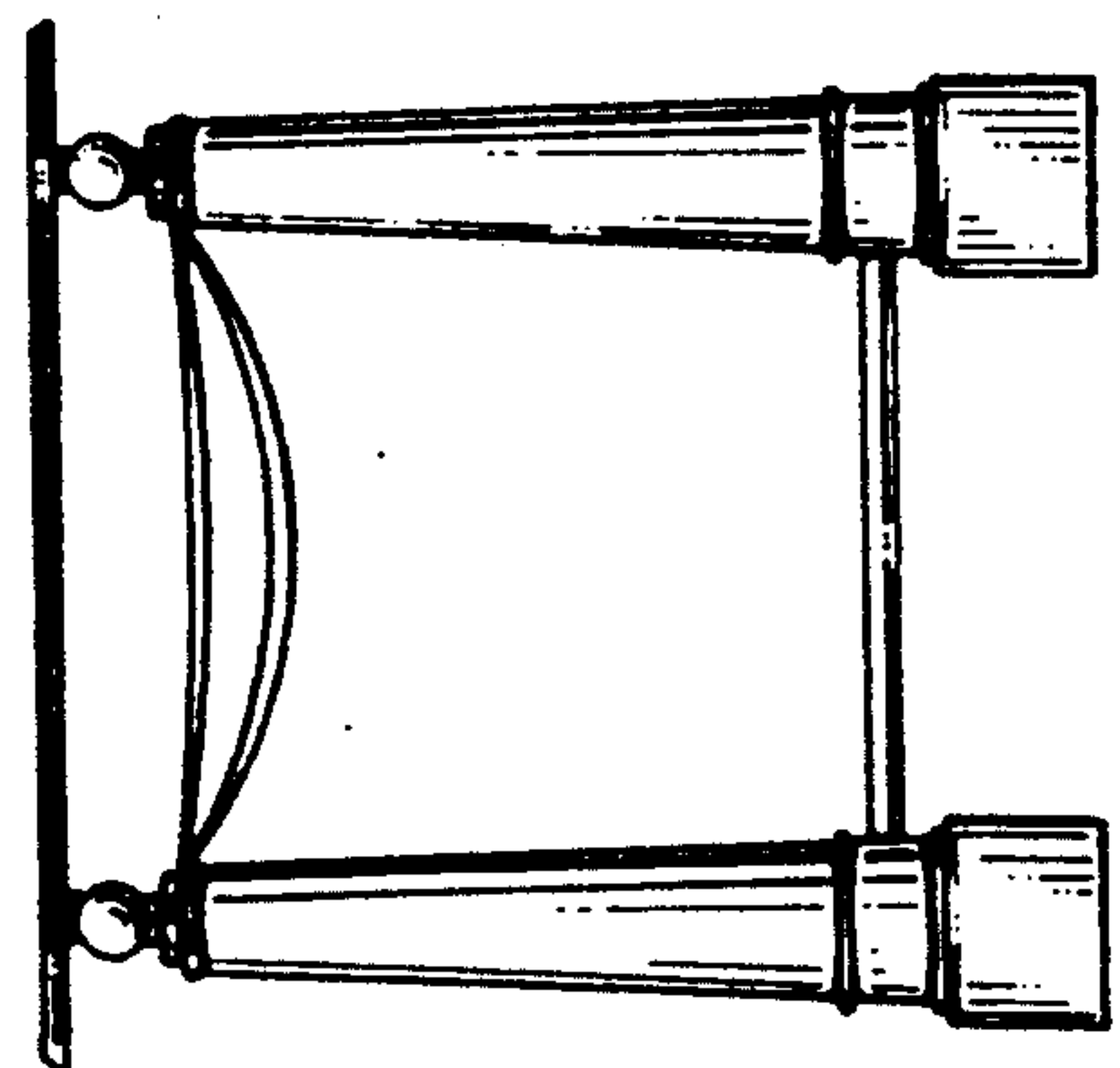

Fig. 7