



US00D343961S

United States Patent [19] Gibbs

[11] Patent Number: **Des. 343,961**

[45] Date of Patent: **** Feb. 8, 1994**

[54] **LAWN CHAIR**

[75] Inventor: **Terence E. Gibbs, Grandview, N.Y.**

[73] Assignee: **Shin Yeh Enterprise Co., Ltd., Taiwan**

[**] Term: **14 Years**

[21] Appl. No.: **886,981**

[22] Filed: **May 20, 1992**

[52] U.S. Cl. **D6/369; D6/370; D6/379**

[58] Field of Search **D6/334, 369, 370, 374, D6/375, 376, 379, 380, 394, 500, 501, 502; 297/418, 446**

[56] **References Cited**

U.S. PATENT DOCUMENTS

D. 407	9/1851	Hutton	D6/394
D. 297,993	10/1988	Kaminski	D6/500
D. 317,536	6/1991	Hess	D6/379 X
D. 324,786	3/1992	Saiger	D6/379
D. 333,750	3/1993	Hess	D6/500

D. 335,040	4/1993	Tseng	D6/370
D. 336,174	6/1993	Lamalle	D6/379

OTHER PUBLICATIONS

Brown Jordan, ©1986, p. 32, Chair "D" at bottom right.

Brown Jordan, Chair #1450-2209 at top right.

Primary Examiner—Nelson C. Holtje

Assistant Examiner—Gary D. Watson

Attorney, Agent, or Firm—Ladas & Parry

[57] **CLAIM**

The ornamental design for lawn chair, as shown and described.

DESCRIPTION

FIG. 1 is a perspective view of lawn chair showing my new design;

FIG. 2 is a front elevational view thereof;

FIG. 3 is a rear elevational view thereof;

FIG. 4 is a left side elevational view thereof;

FIG. 5 is a right side elevational view thereof;

FIG. 6 is a top plan view thereof; and,

FIG. 7 is a bottom plan view thereof.

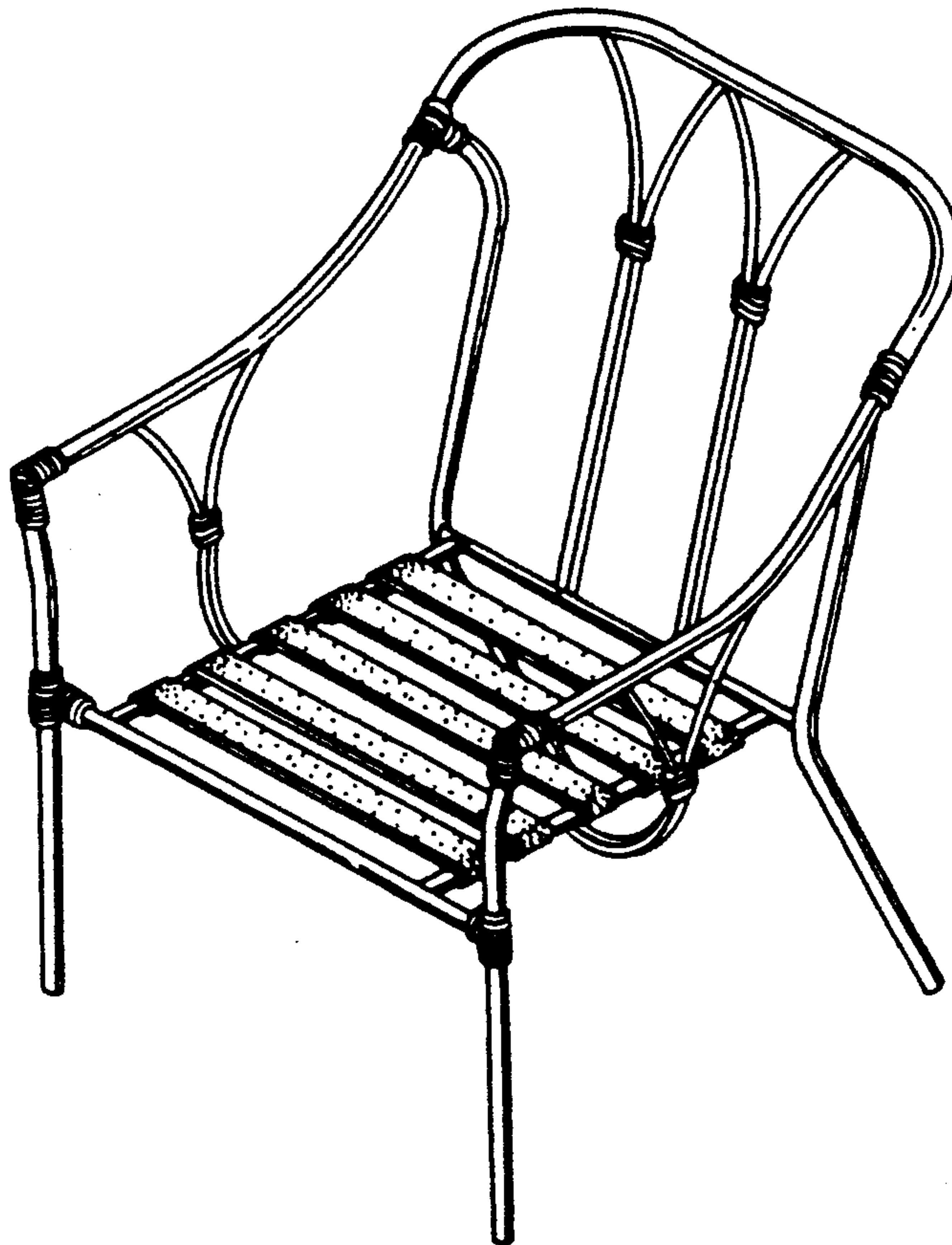

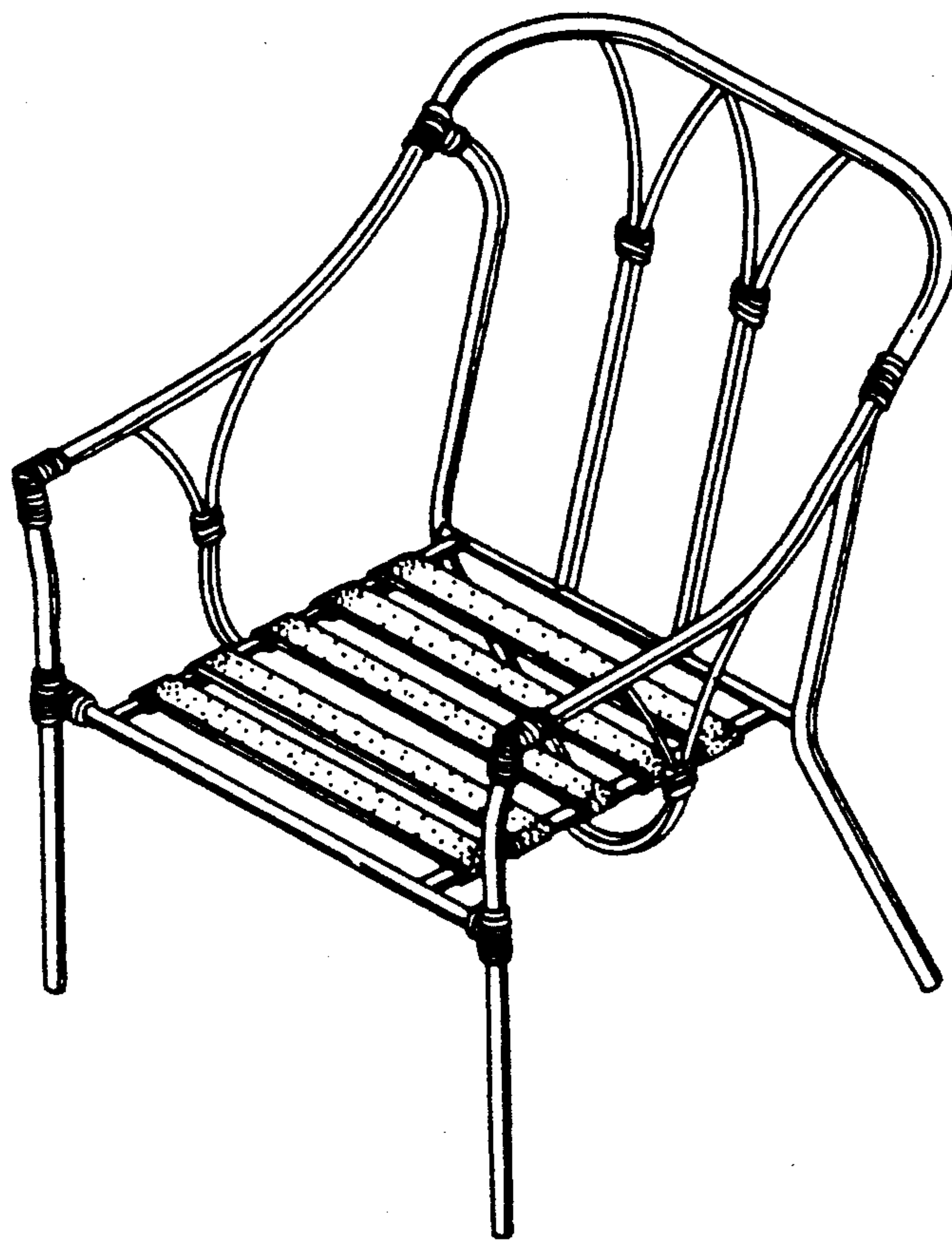

FIG. 1

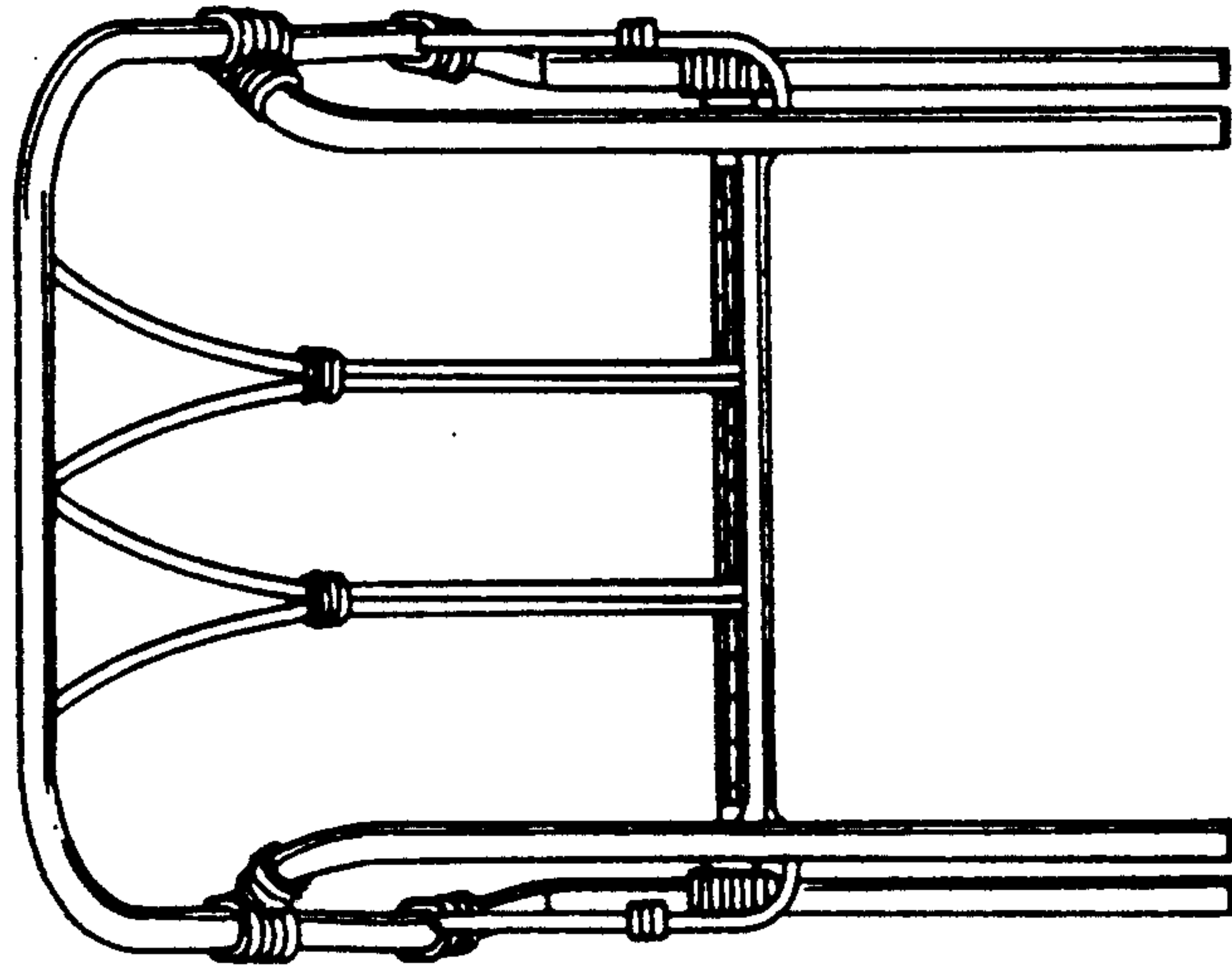

FIG. 2

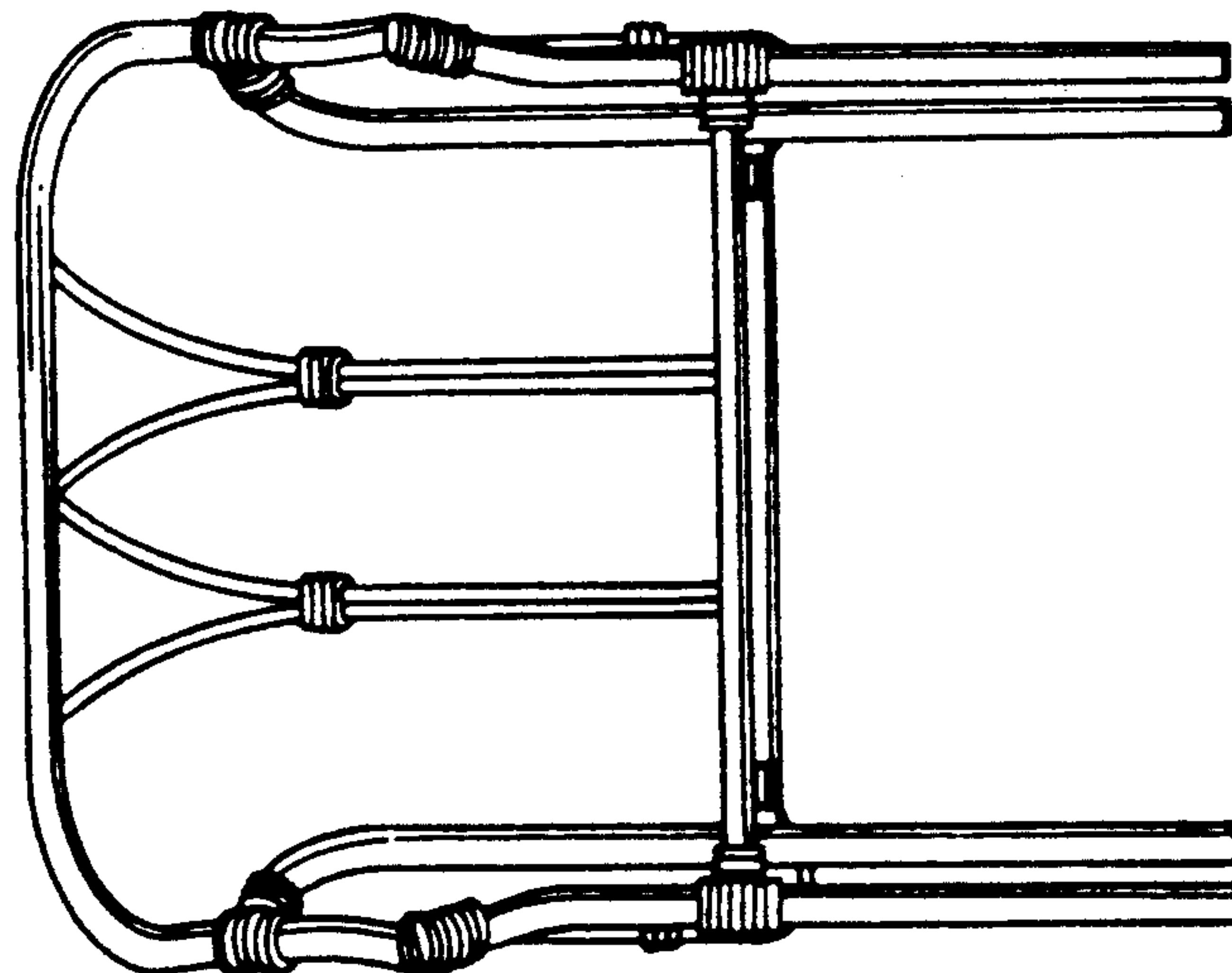

FIG. 3

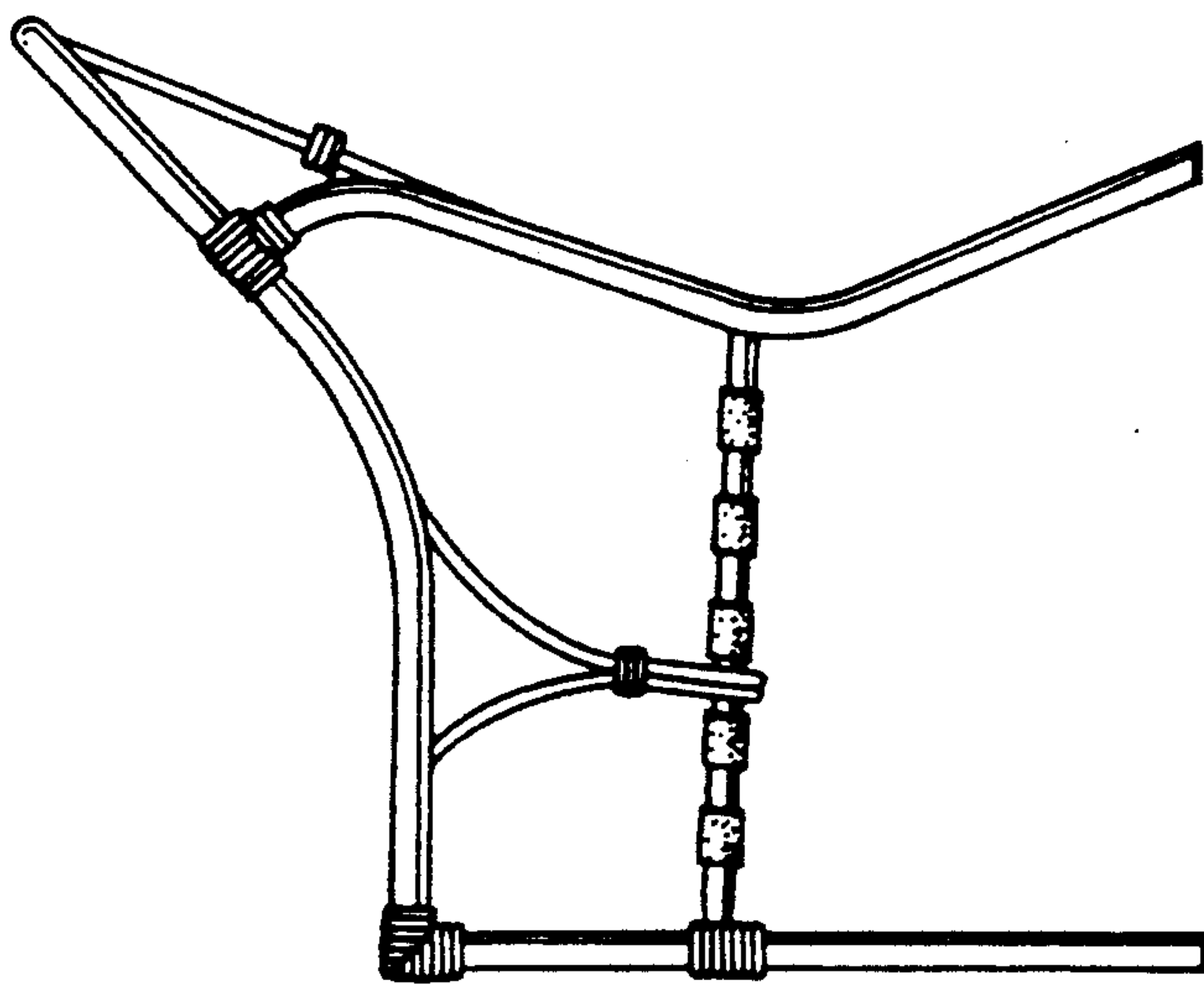

FIG. 5

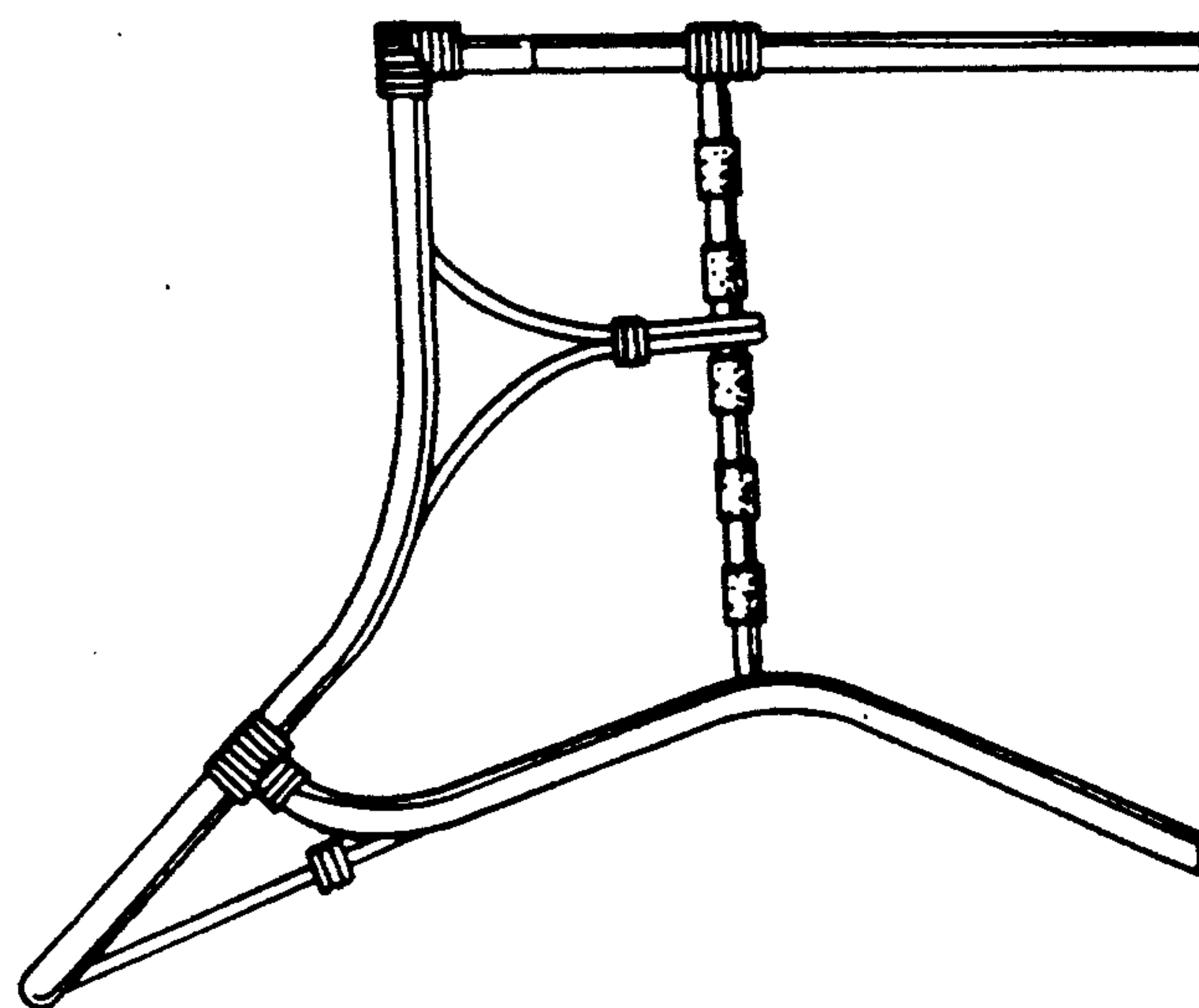

FIG. 4

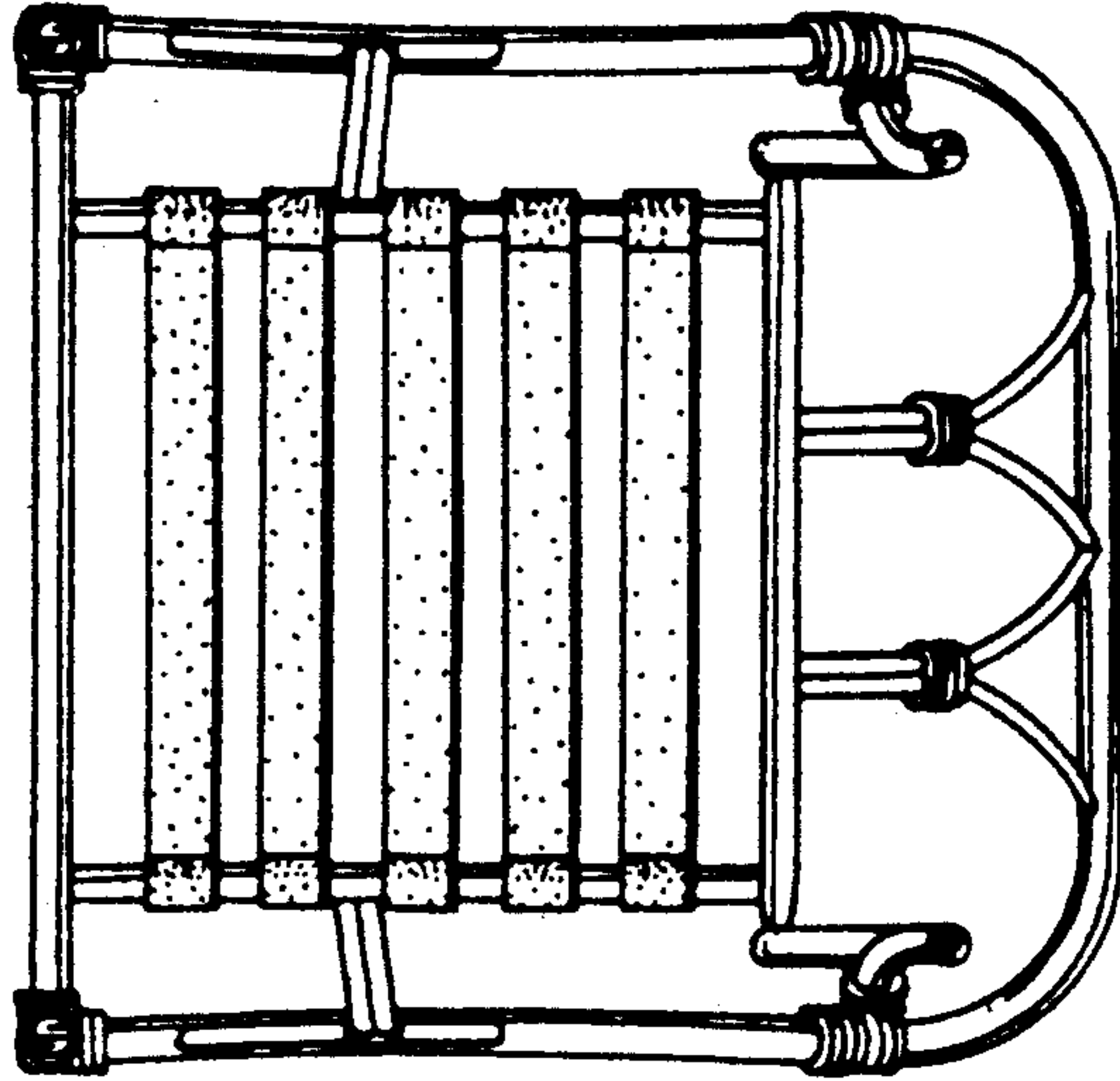

FIG. 7

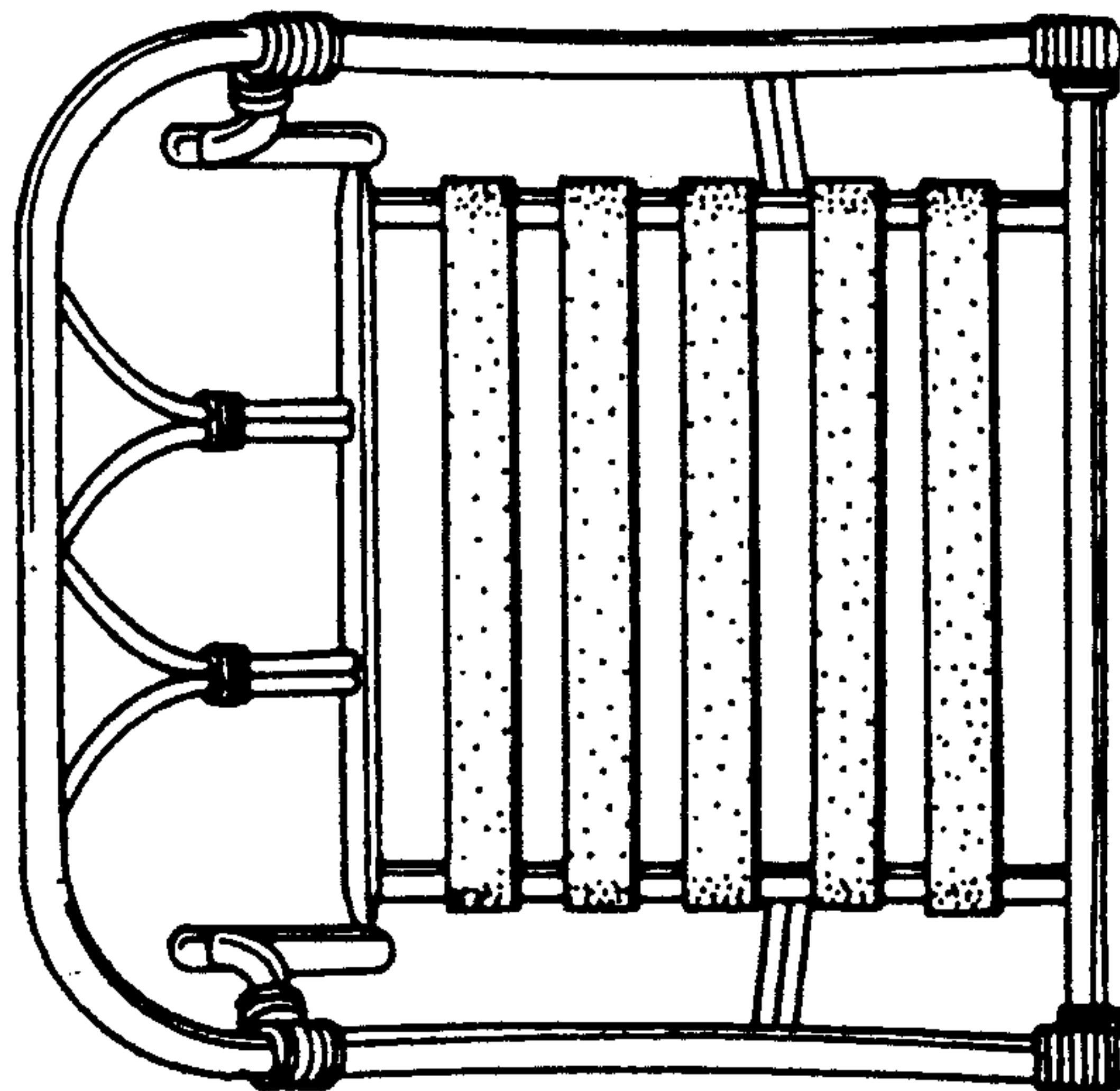

FIG. 6