



US00D343906S

United States Patent [19]

Murray

[11] Patent Number: **Des. 343,906**

[45] Date of Patent: **** Feb. 1, 1994**

[54] **STEP LADDER HAVING RECESSED STEPS**

[76] Inventor: **Jules Murray, R.R. #2, Bracebridge, Ontario, Canada, P1L 1W9**

[**] Term: **14 Years**

[21] Appl. No.: **843,287**

[22] Filed: **Feb. 28, 1992**

[52] U.S. Cl. **D25/64**

[58] Field of Search 182/23, 156, 163, 180, 182/194, 15, 32, 33, 106, 111, 166; D25/64

[56] **References Cited**

U.S. PATENT DOCUMENTS

600,730	3/1898	Lincoln	182/106
716,149	12/1902	Tratton	182/111
2,010,588	8/1935	Gooden	182/106
2,167,157	7/1939	Muehlberg	182/106
2,467,800	4/1949	Backlin et al.	182/106
2,857,087	10/1958	Pratt	182/166
2,899,008	8/1959	Larson	182/166

3,085,651	4/1963	Rich	D25/64
3,288,247	11/1966	Barnes	182/106
4,125,175	11/1978	Ernst	182/194
4,719,990	1/1988	Markovic	182/166

Primary Examiner—A. Hugo Word
Assistant Examiner—Doris Clark
Attorney, Agent, or Firm—Terry M. Gernstein

[57] **CLAIM**

The ornamental design for a step ladder having recessed steps, as shown and described.

DESCRIPTION

FIG. 1 is a perspective view of the step ladder having recessed steps embodying the design of the present invention;

FIG. 2 is a side elevational view thereof, the side opposite being a mirror image of the side shown in FIG. 2;

FIG. 3 is a front elevational view thereof;

FIG. 4 is a rear elevational view thereof;

FIG. 5 is a top plan view thereof; and,

FIG. 6 is a bottom view thereof.

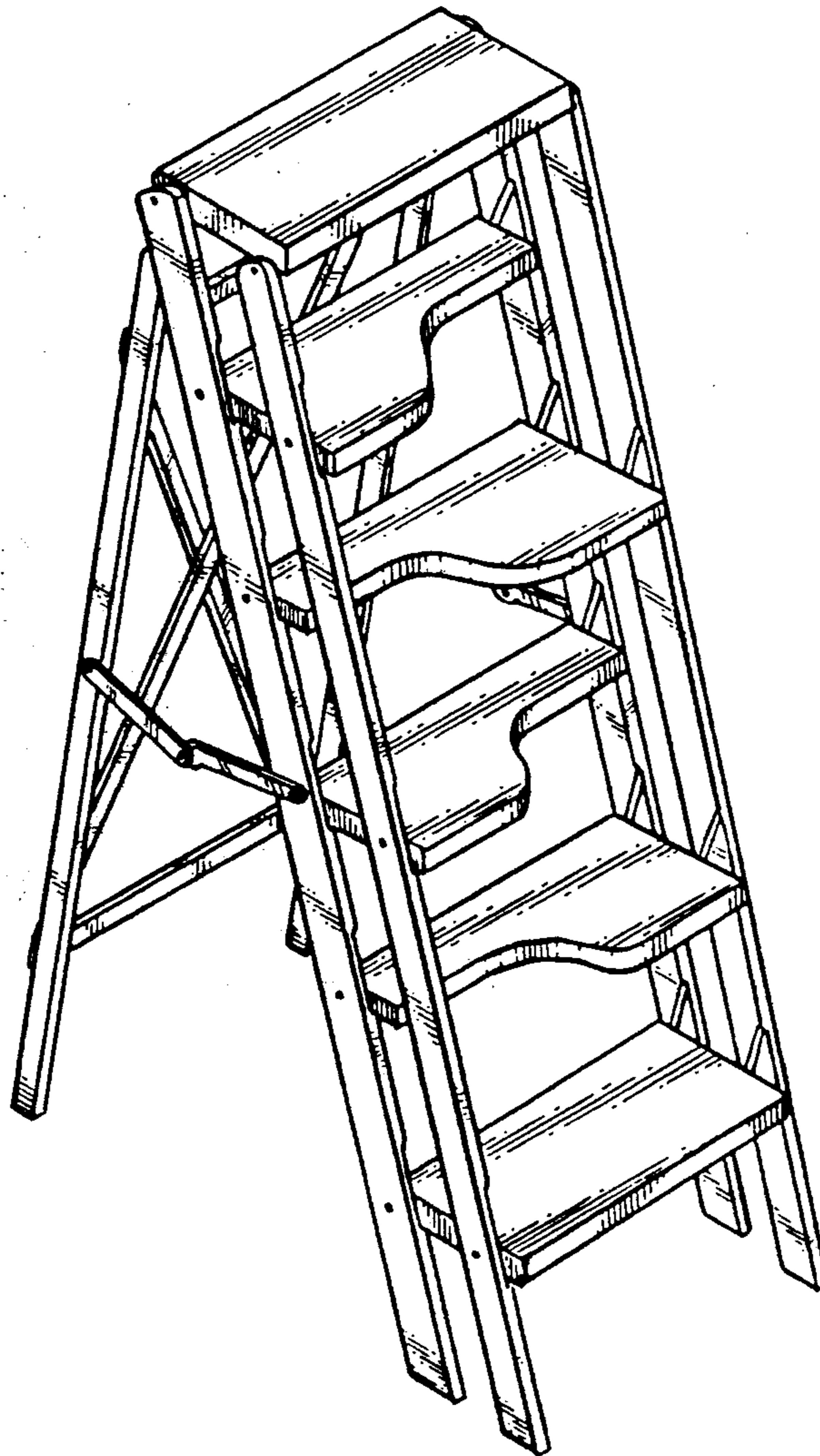

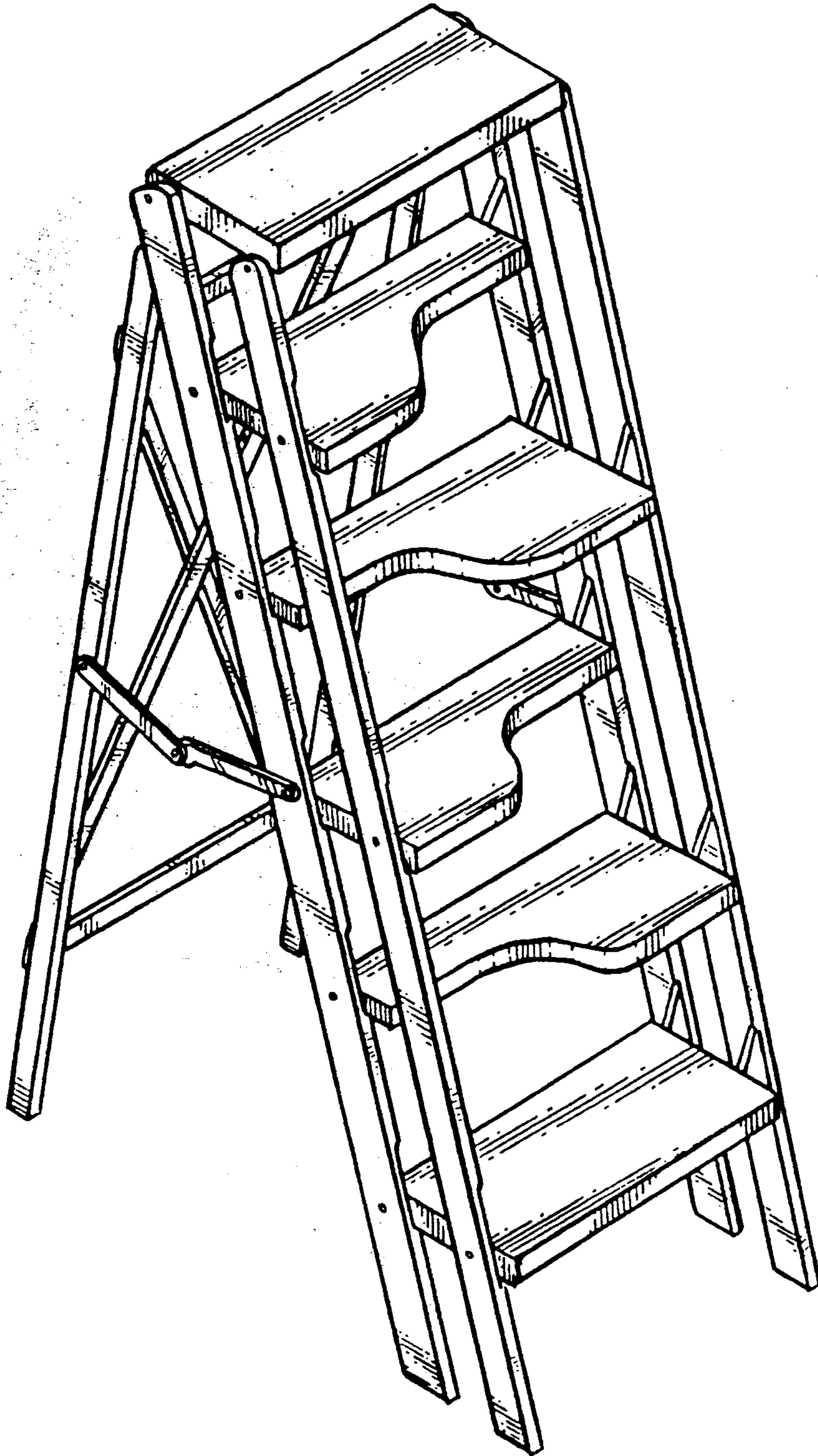

FIG. 1

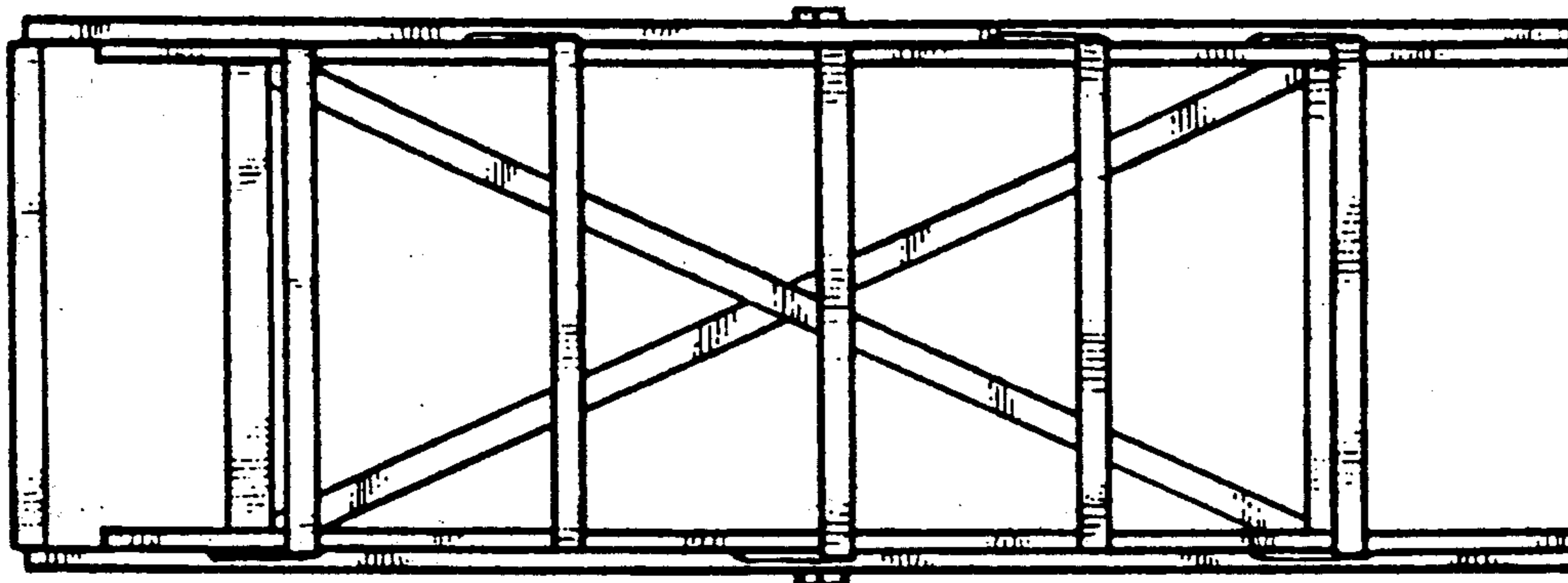

FIG. 4

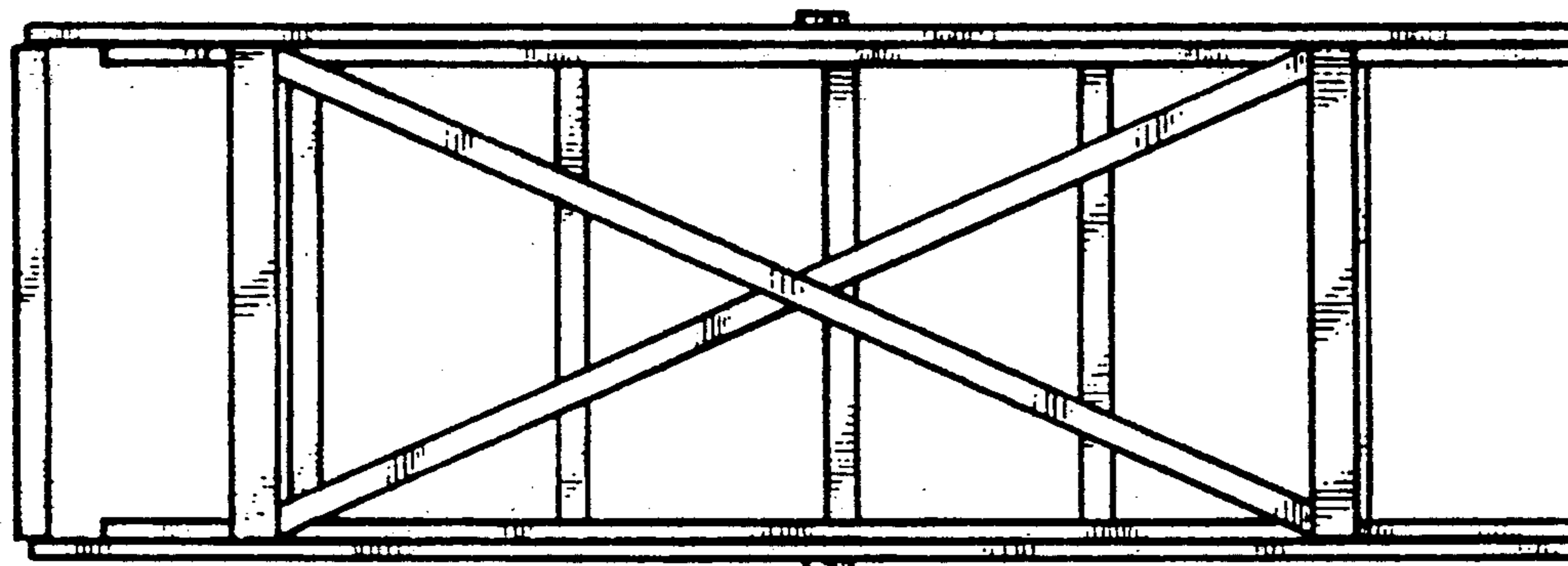

FIG. 3

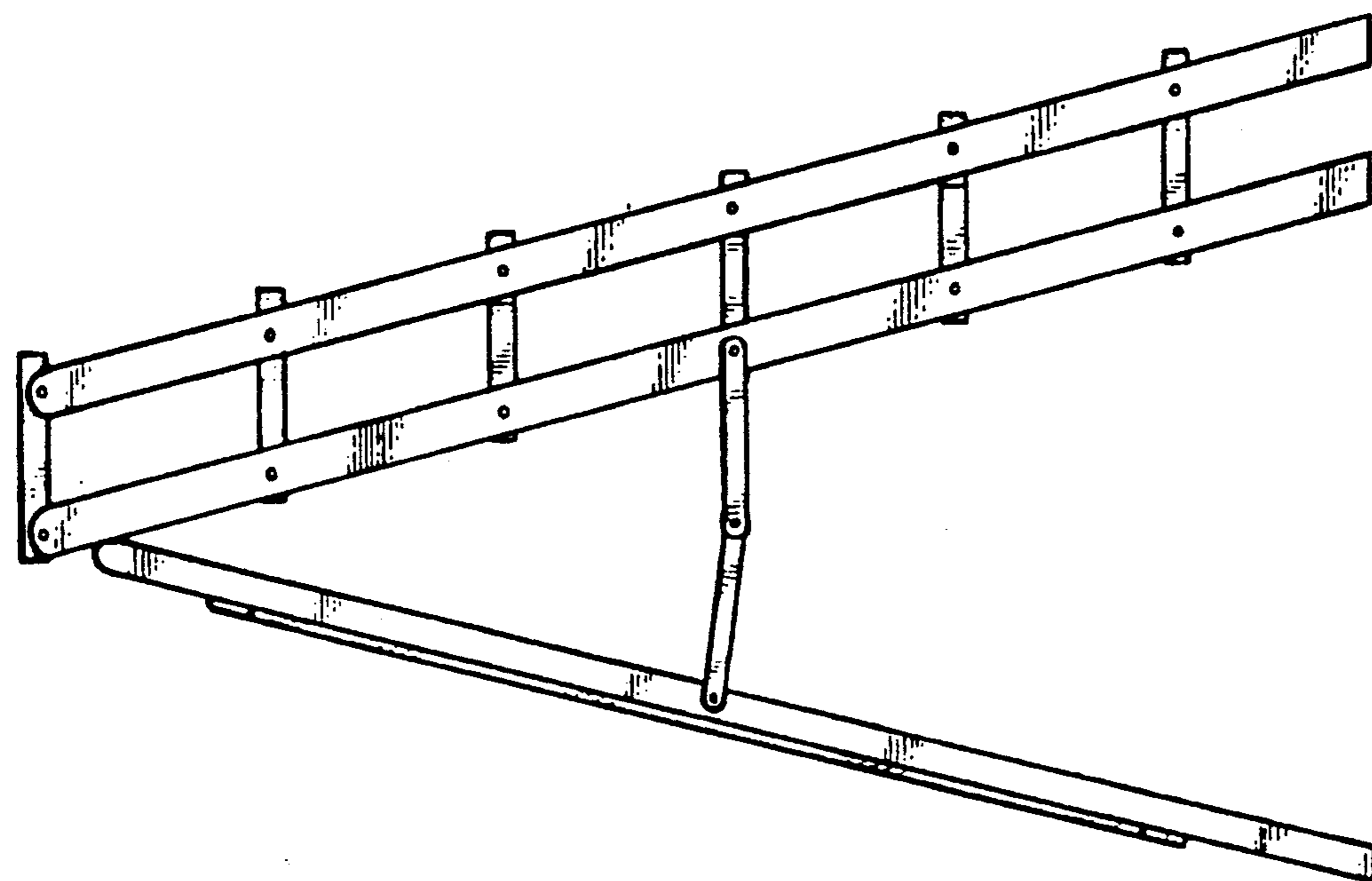

FIG. 2

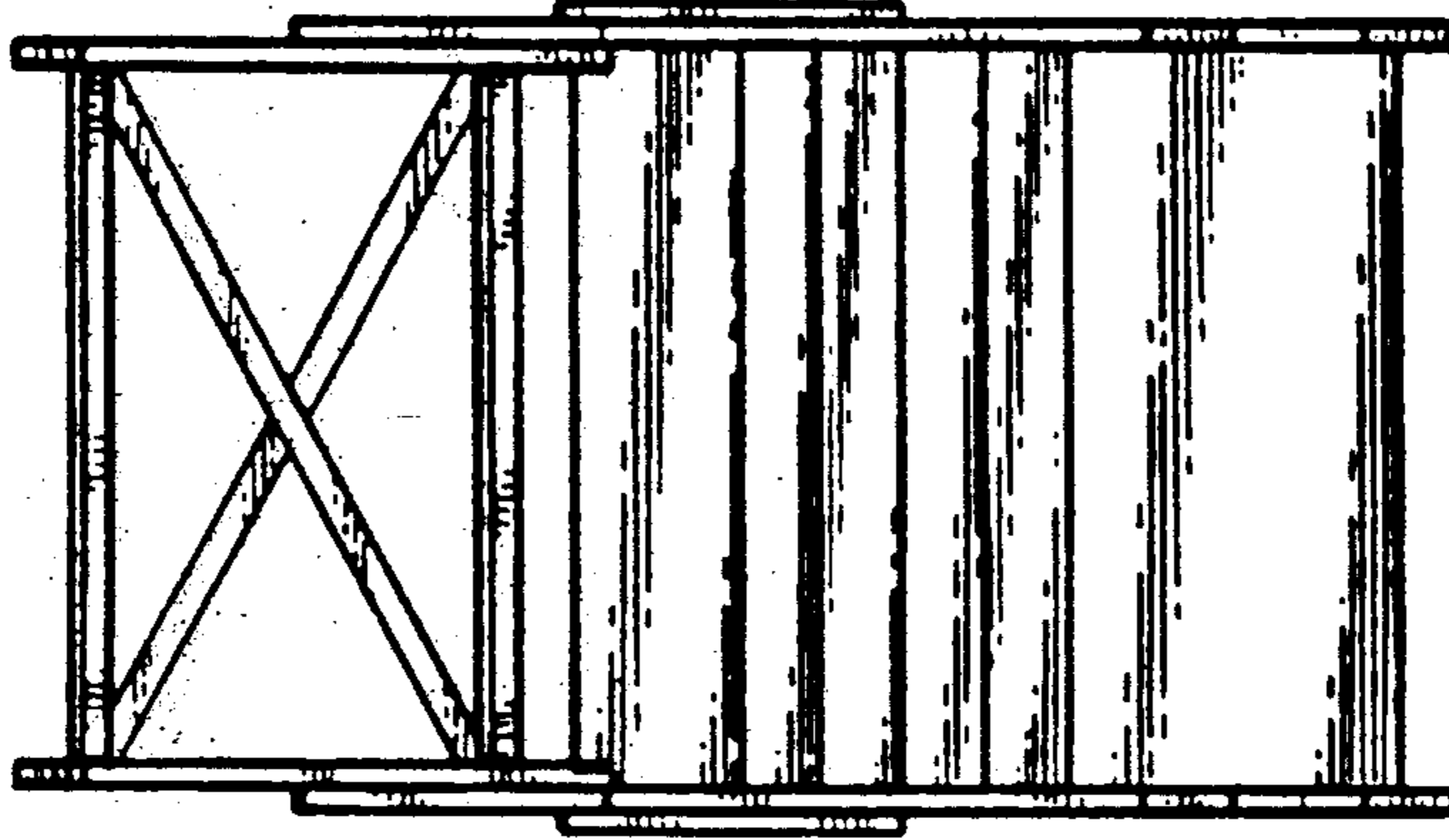

FIG. 6

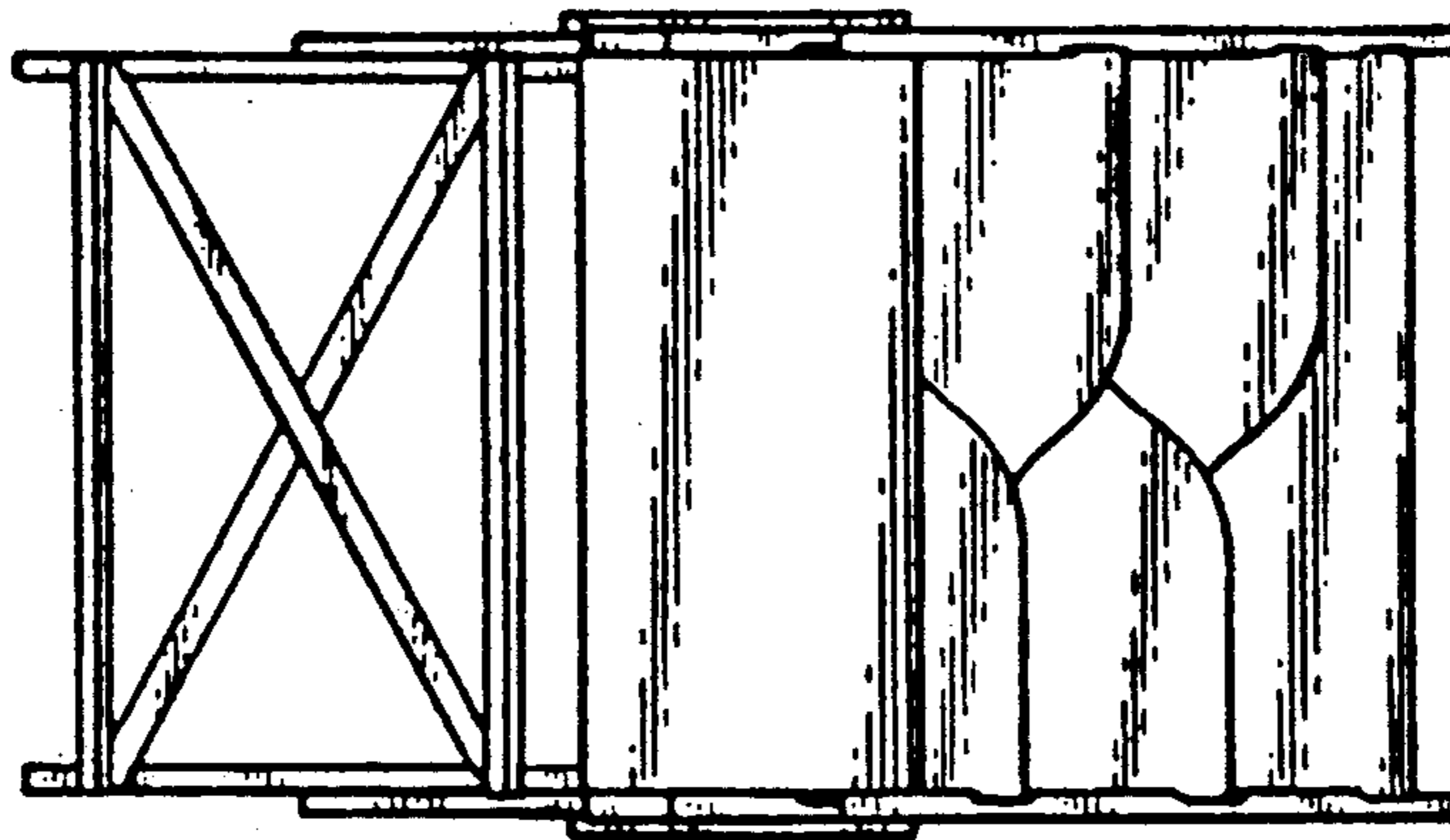

FIG. 5