



US00D343751S

United States Patent [19]

Bell et al.

[11] Patent Number: **Des. 343,751**

[45] Date of Patent: **** Feb. 1, 1994**

[54] **DISPENSER FOR SOAP OR SIMILAR VISCIOUS MATERIAL**

[75] Inventors: **Ronald F. Bell**, Uniontown; **Thomas Kearnes**, Richfield, both of Ohio

[73] Assignee: **Gojo Industries, Inc.**, Cuyahoga Falls, Ohio

[**] Term: **14 Years**

[21] Appl. No.: **878,311**

[22] Filed: **May 4, 1992**

[52] U.S. Cl. **D6/545**

[58] Field of Search **D6/542-545;**
222/94, 105, 129, 135, 156, 173, 180-181, 185,
630-631; 221/282-286

[56] **References Cited**

U.S. PATENT DOCUMENTS

- D. 253,441 11/1979 Tucker D6/545
- D. 273,062 3/1984 Richardson D6/545
- D. 276,294 11/1984 Banks D6/545

- D. 279,530 7/1985 von Buelon D6/545
- D. 285,272 8/1986 Bunschuten et al. D6/545
- D. 302,917 8/1989 Banks D6/545
- D. 316,498 4/1991 Barry D6/545 X
- 4,130,224 12/1978 Norman et al. 222/185
- 4,164,306 8/1979 Perrin 222/181

Primary Examiner—Brian N. Vinson
Attorney, Agent, or Firm—Reese Taylor

[57] **CLAIM**

The ornamental design for a dispenser for soap or similar viscous material, as shown and described.

DESCRIPTION

FIG. 1 is a perspective view of a dispenser for soap or similar viscous material showing my new design; FIG. 2 is a front elevational view thereof; FIG. 3 is a rear elevational view thereof; FIG. 4 is a side elevational view taken from the left of FIG. 1, the right side being a mirror image thereof; FIG. 5 is a top plan view thereof; and, FIG. 6 is a bottom plan view thereof.

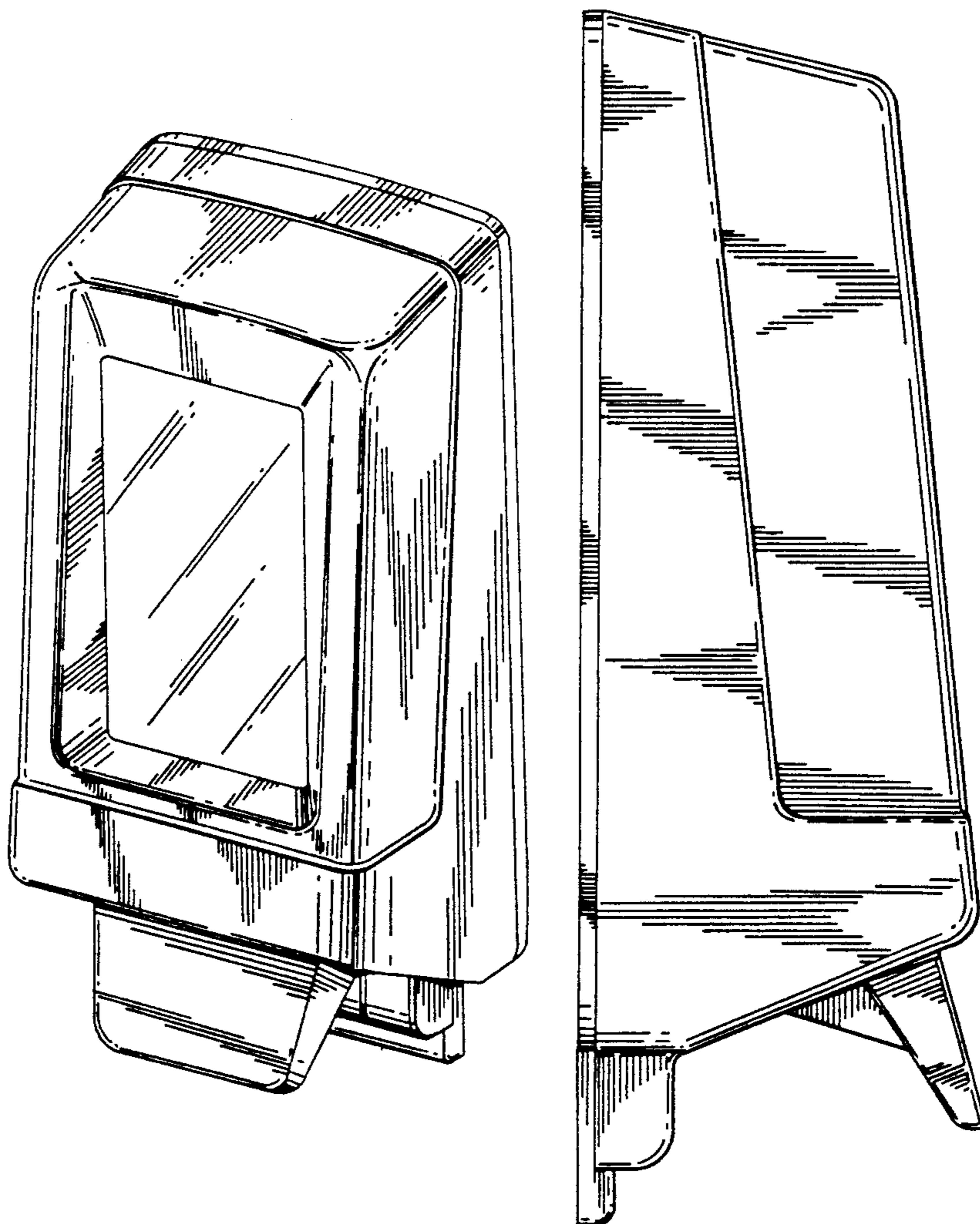

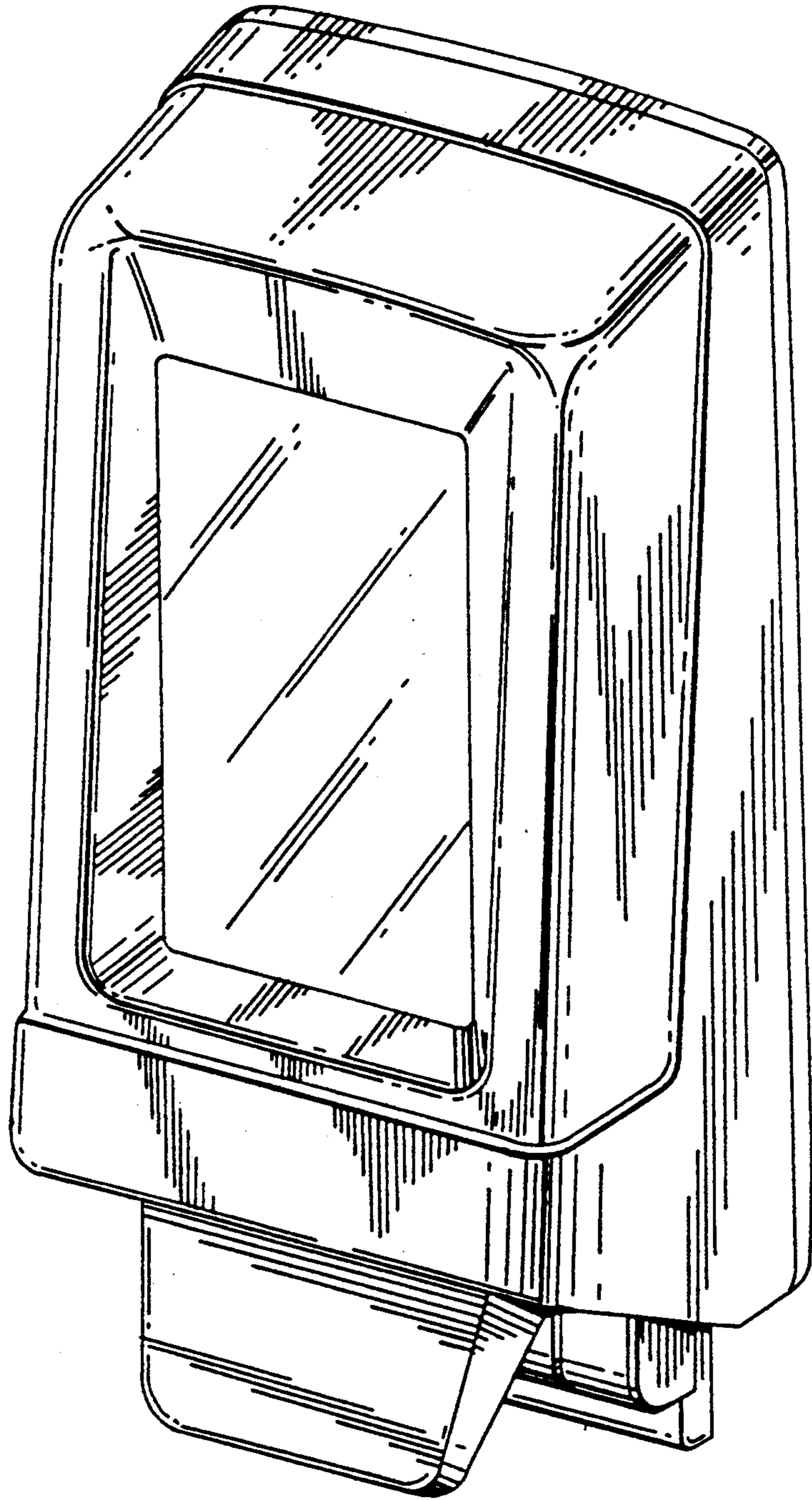

FIG. 1

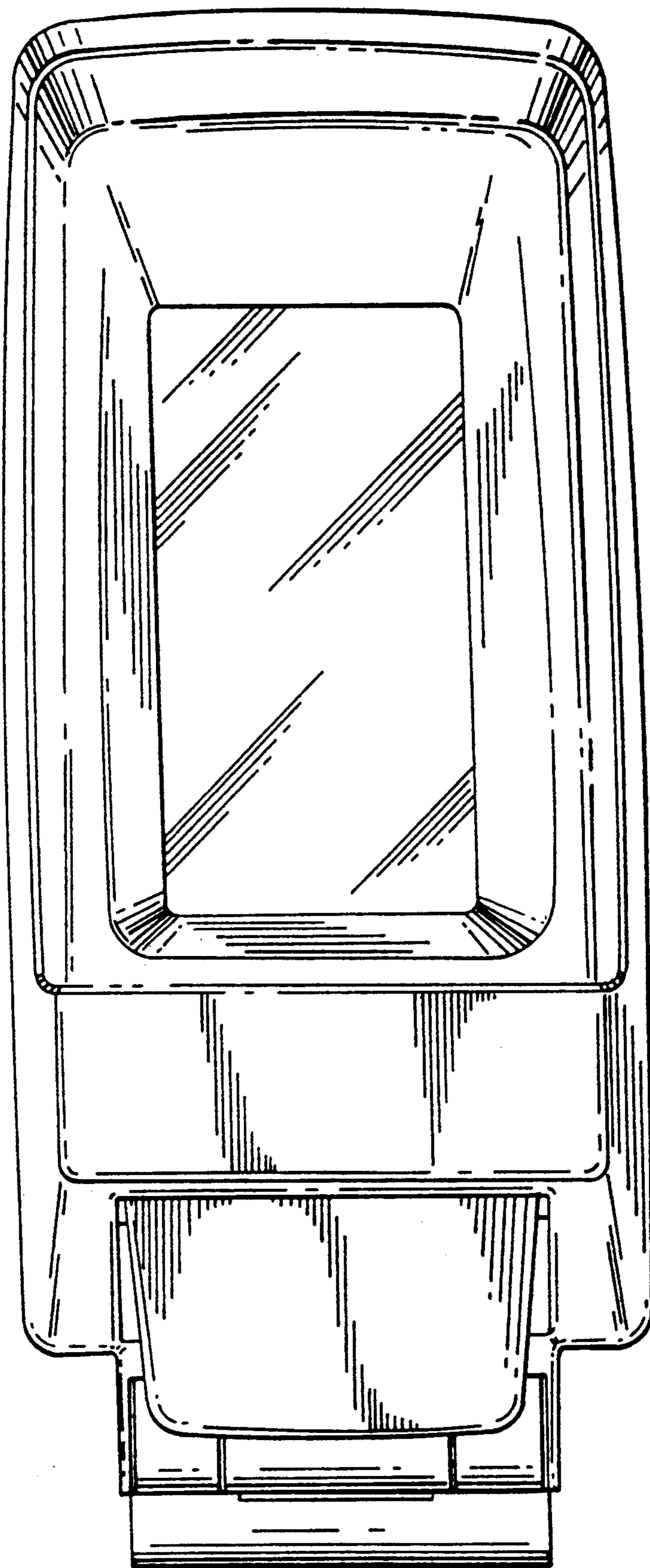

FIG. 2

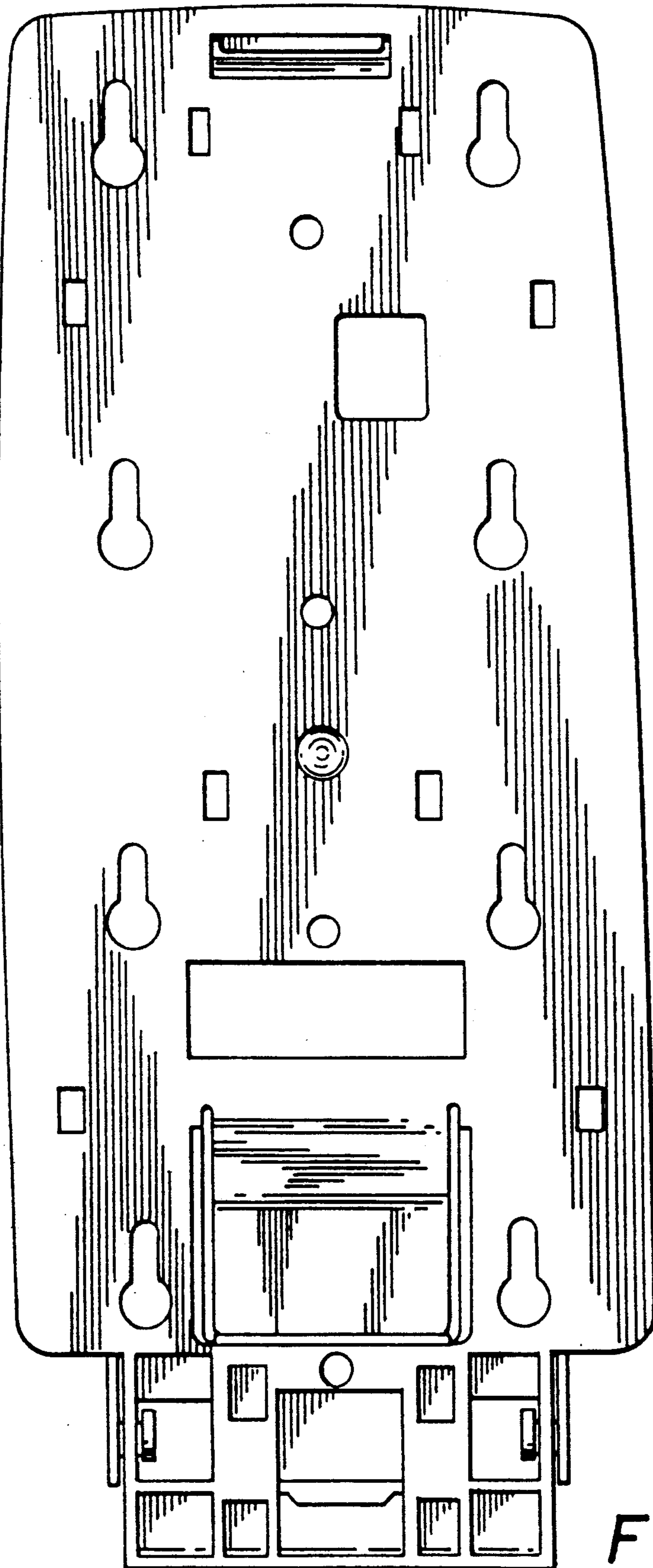

FIG. 3

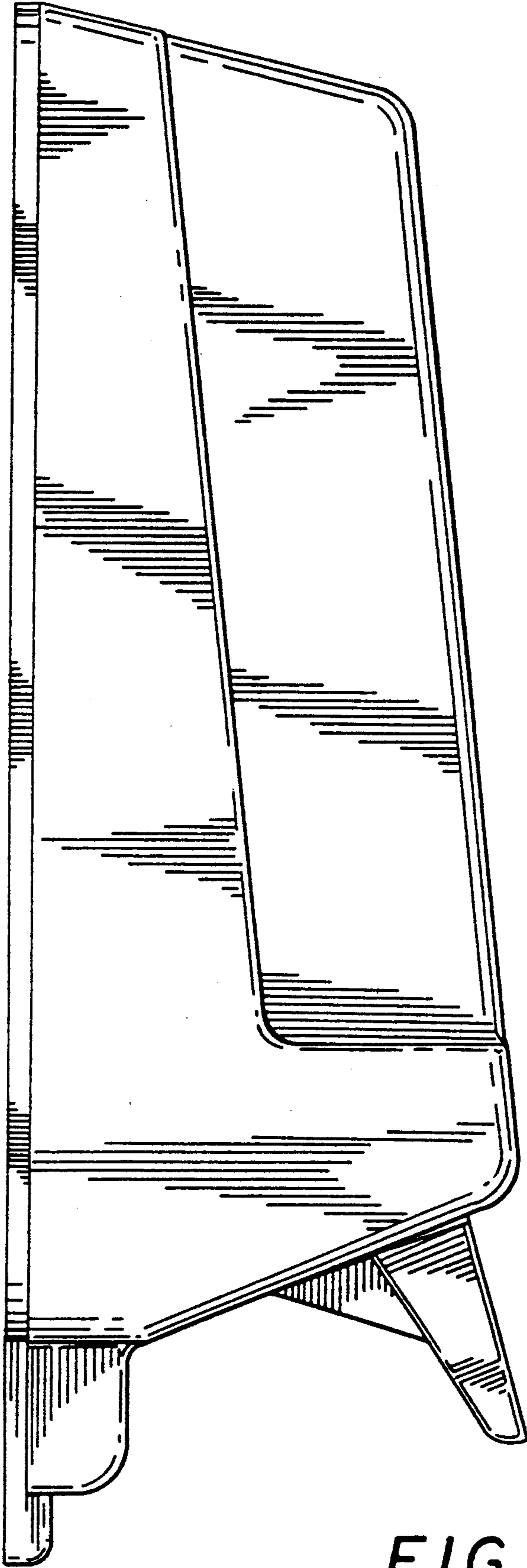

FIG. 4

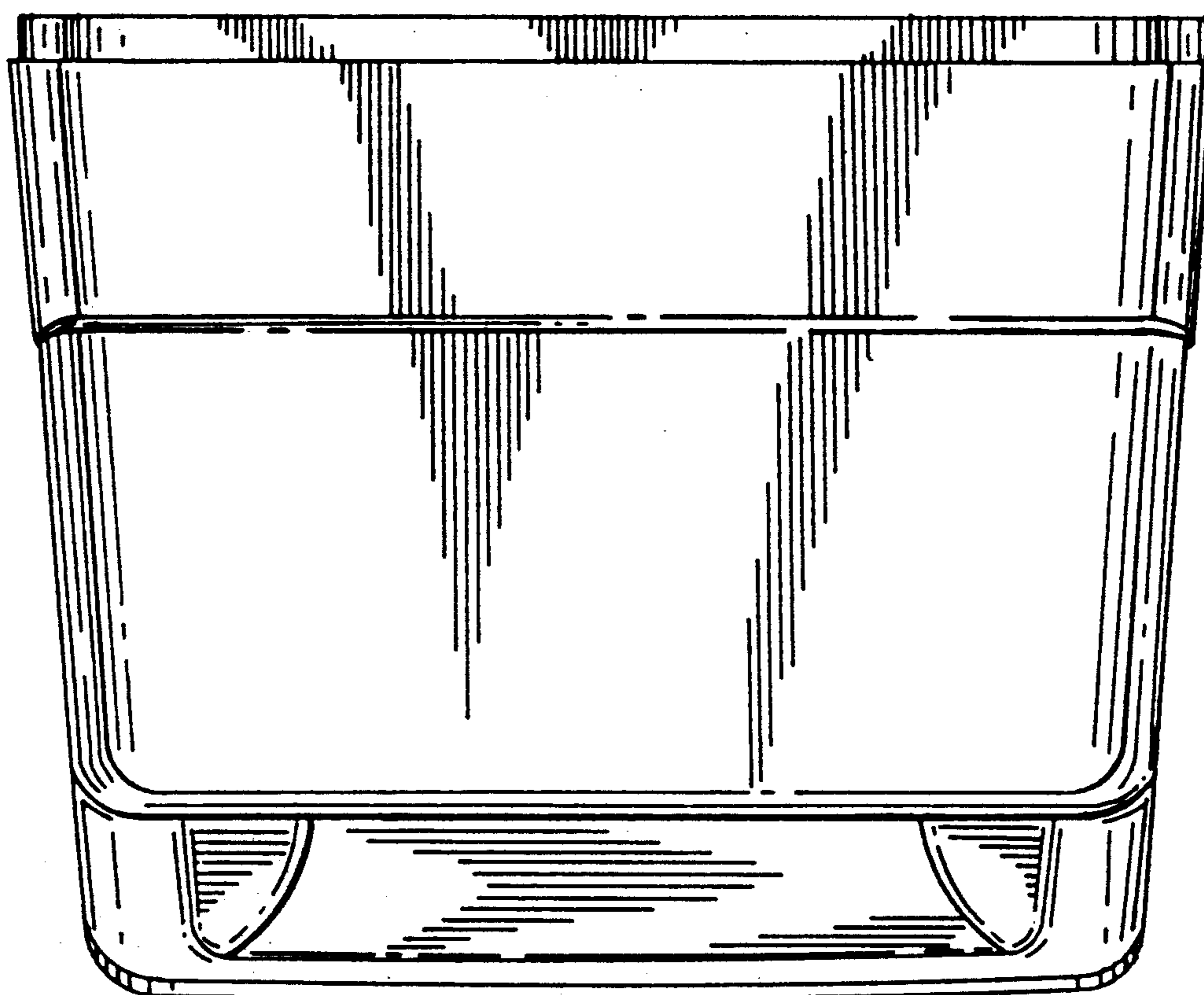

FIG. 5

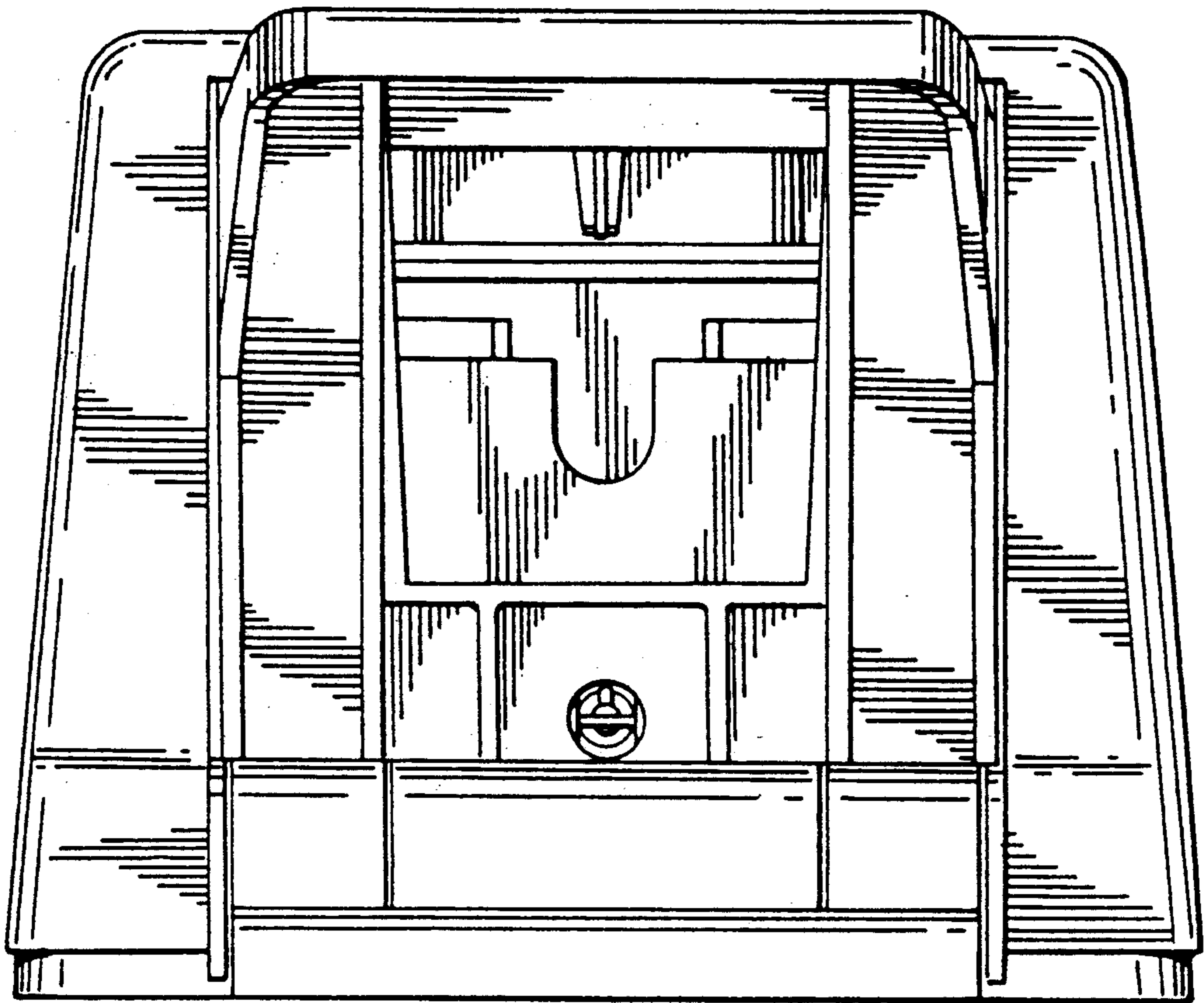

FIG. 6