



US00D343672S

United States Patent [19]

[11] Patent Number: **Des. 343,672**

Kobayashi et al.

[45] Date of Patent: **** Jan. 25, 1994**

[54] **FISHING REEL**

[75] Inventors: **Satoshi Kobayashi, Musashino; Shinji Murakami; Shinichiro Miyasaka,**
both of Higashikurume, all of Japan

[73] Assignee: **Daiwa Seiko, Inc., Tokyo, Japan**

[**] Term: **14 Years**

[21] Appl. No.: **817,410**

[22] Filed: **Jan. 6, 1992**

[30] **Foreign Application Priority Data**

Jul. 11, 1991 [JP]	Japan	3-20837
Nov. 29, 1991 [JP]	Japan	3-36128
[52] U.S. Cl.		D22/141
[58] Field of Search		242/234-240; D22/141, 140

[56] **References Cited**

U.S. PATENT DOCUMENTS

D. 273,220	3/1984	Iinuma et al.	D22/141
D. 311,051	10/1990	Peterson	D22/141

Primary Examiner—A. Hugo Word
Assistant Examiner—Doris V. Coles
Attorney, Agent, or Firm—Cushman, Darby & Cushman

[57] **CLAIM**

The ornamental design for a fishing reel, as shown and described.

DESCRIPTION

FIG. 1 is a front, top and right side perspective view of a fishing reel showing our new design;
 FIG. 2 is a front elevational view thereof;
 FIG. 3 is a rear elevational view thereof;
 FIG. 4 is a left side elevational view thereof;
 FIG. 5 is a right side elevational view thereof;
 FIG. 6 is a top plan view thereof;
 FIG. 7 is a bottom view thereof;
 FIG. 8 is a front elevational view of the other embodiment showing our new design;
 FIG. 9 is a left side elevational view thereof;
 FIG. 10 is a right side elevational view thereof;
 FIG. 11 is a top plan view thereof;
 FIG. 12 is a rear elevational view thereof; and,
 FIG. 13 is a bottom view thereof.

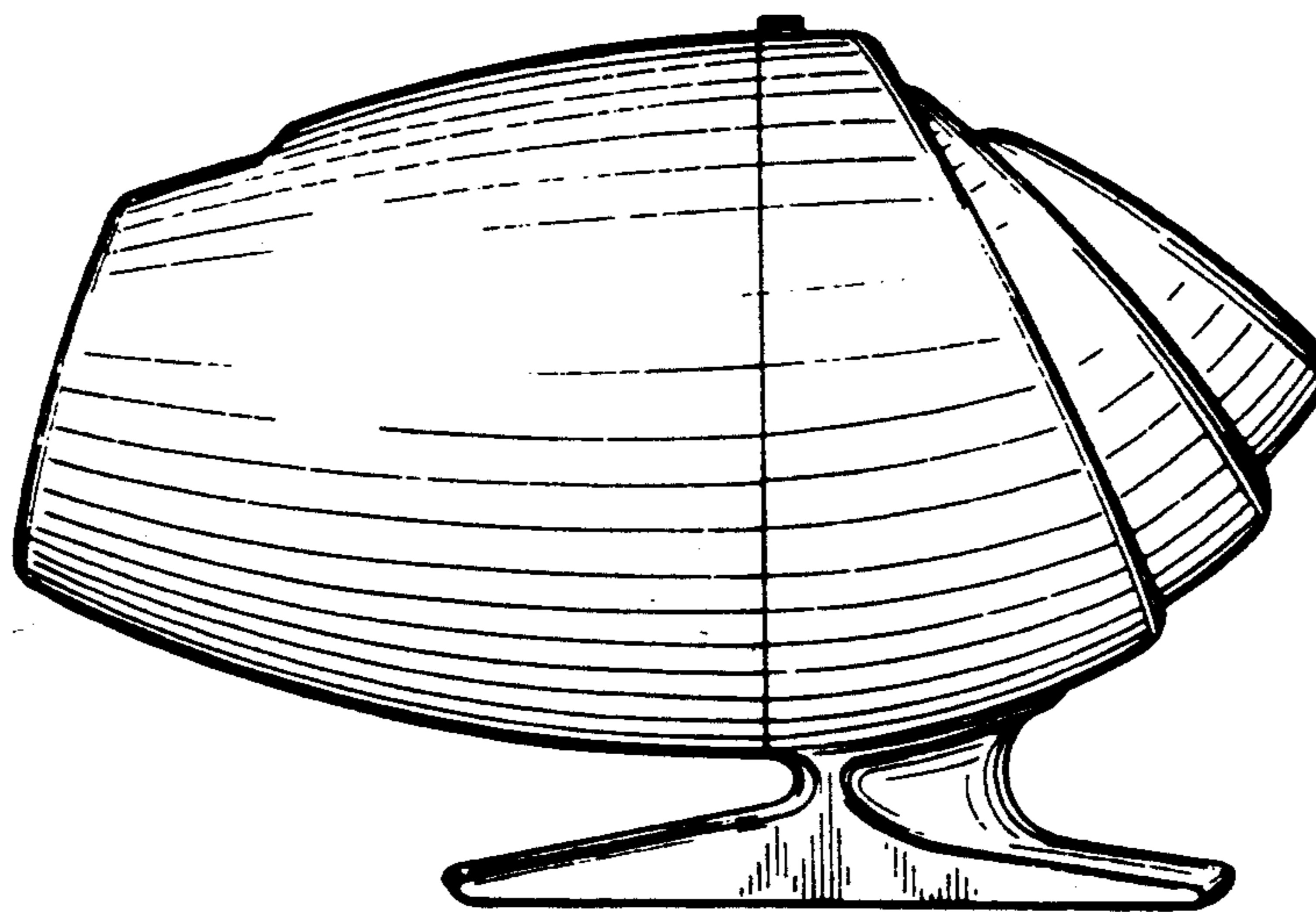

FIG. 1

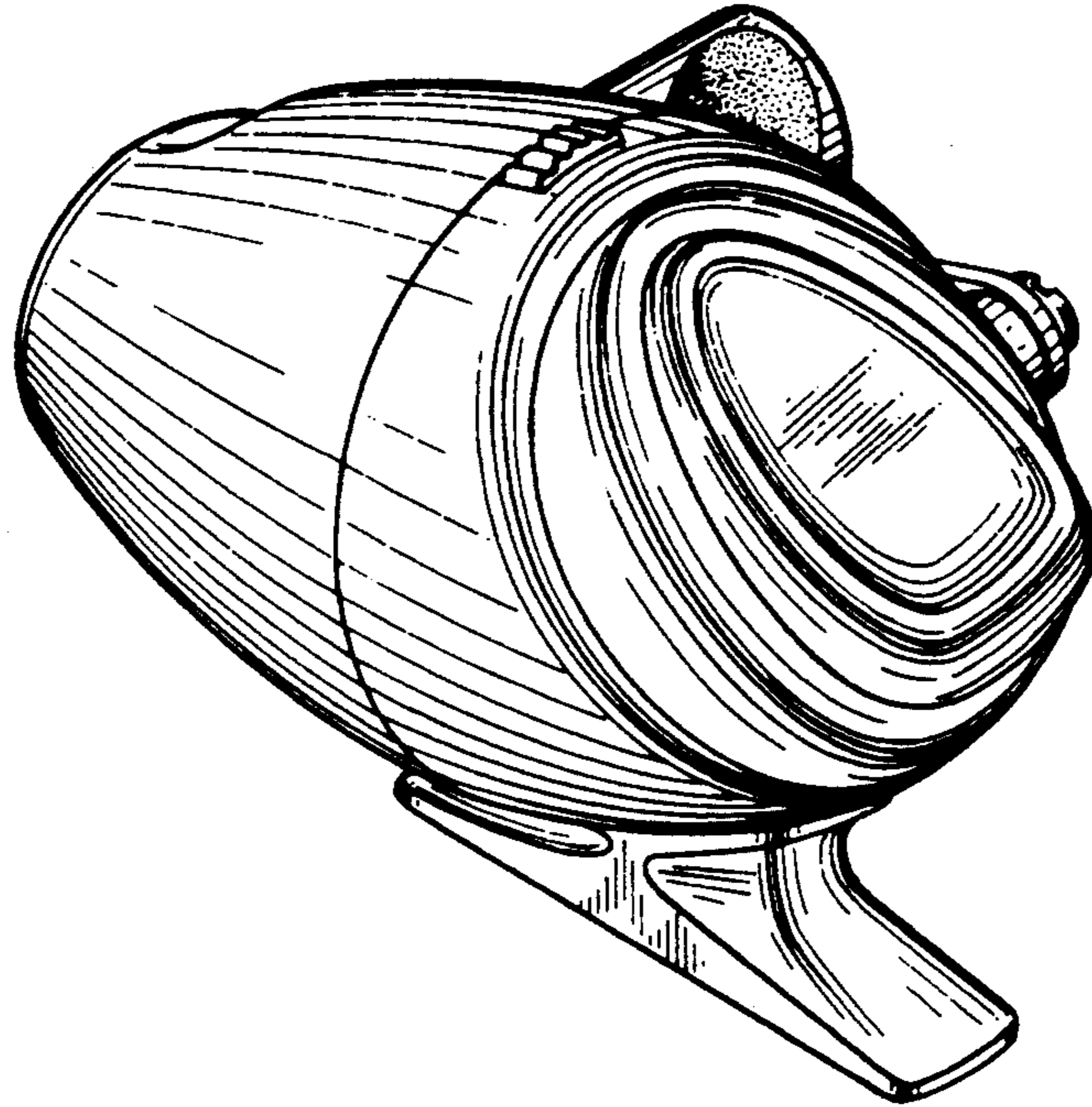

FIG. 2

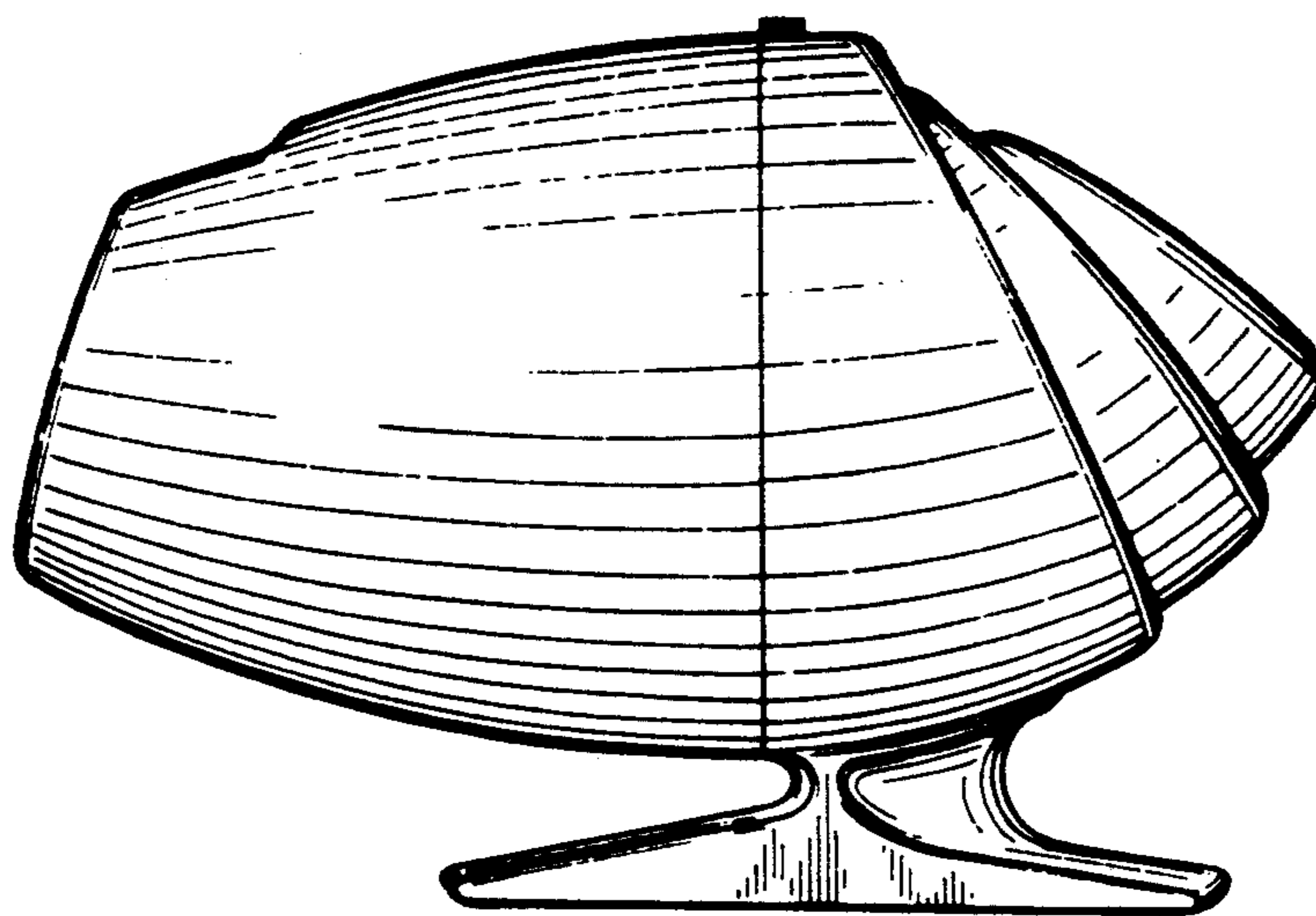

FIG. 3

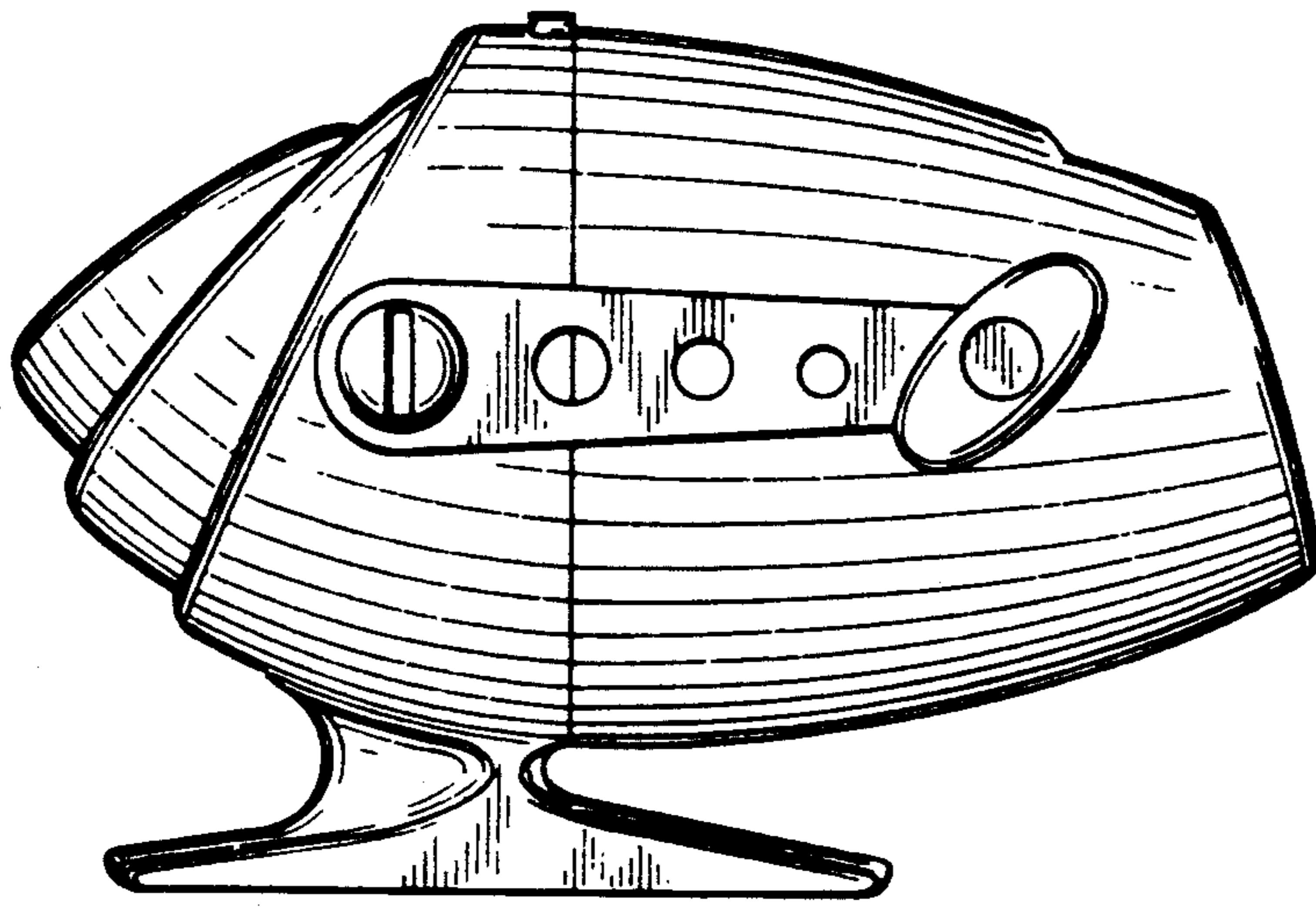

FIG. 4

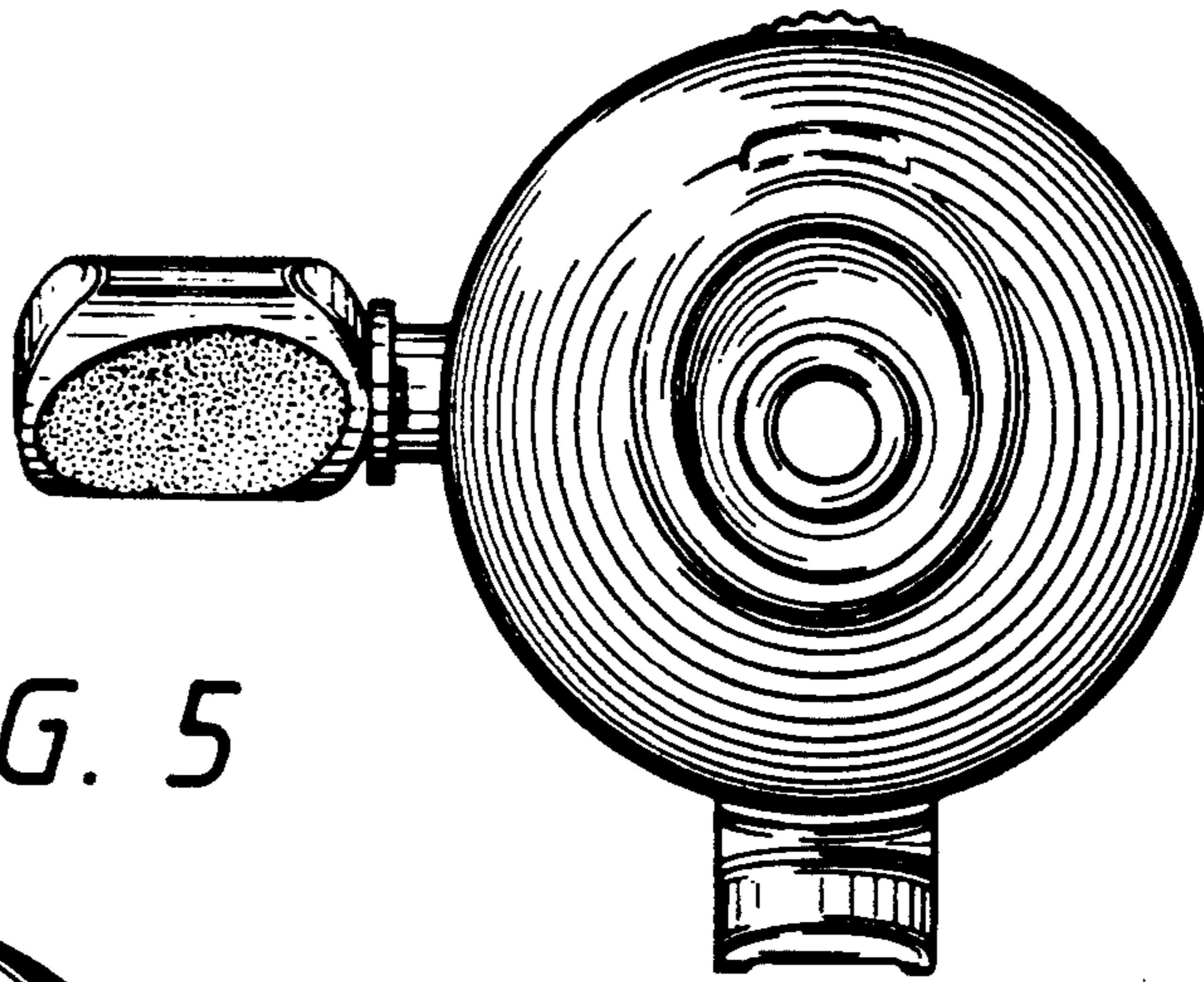

FIG. 5

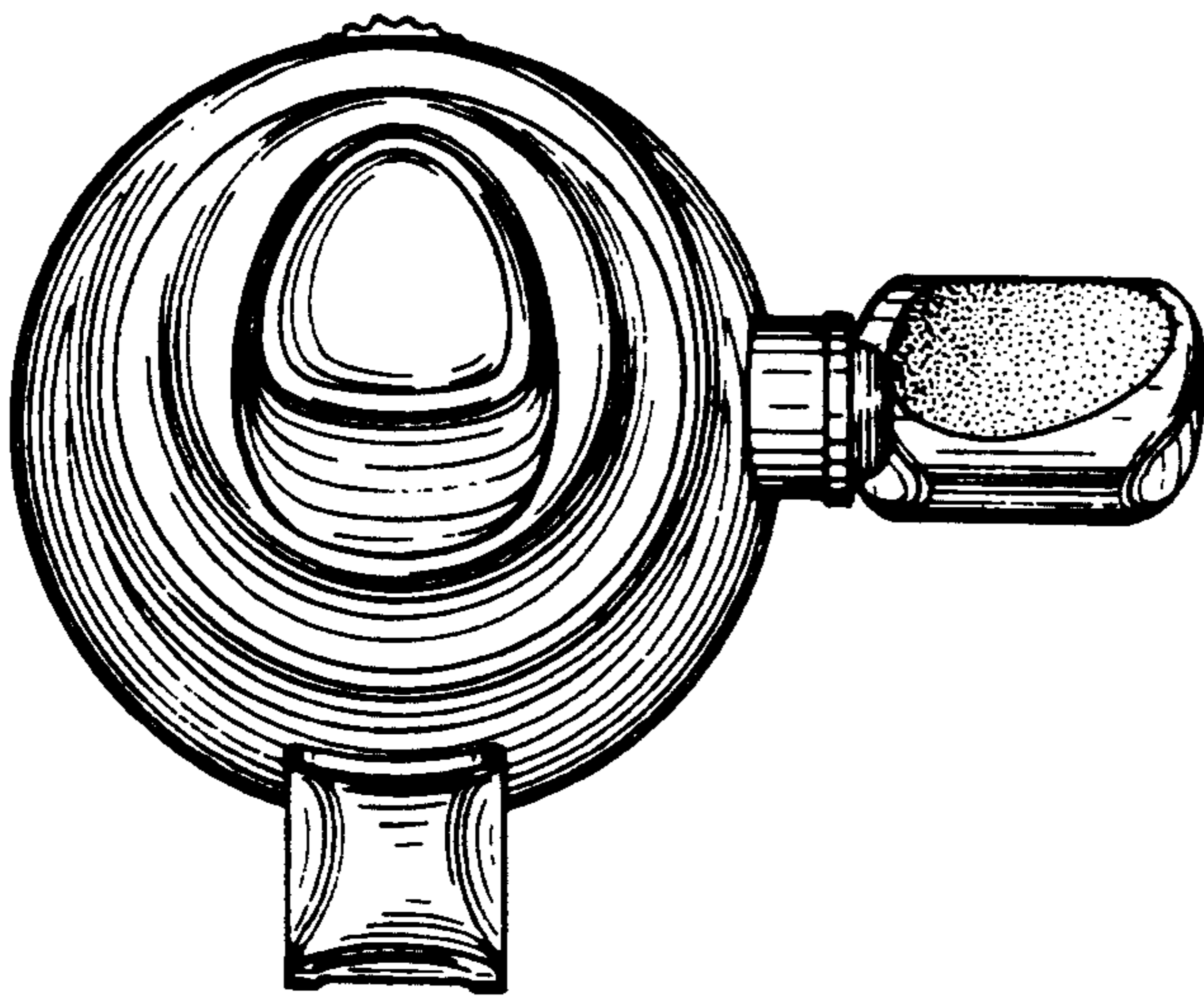

FIG. 6

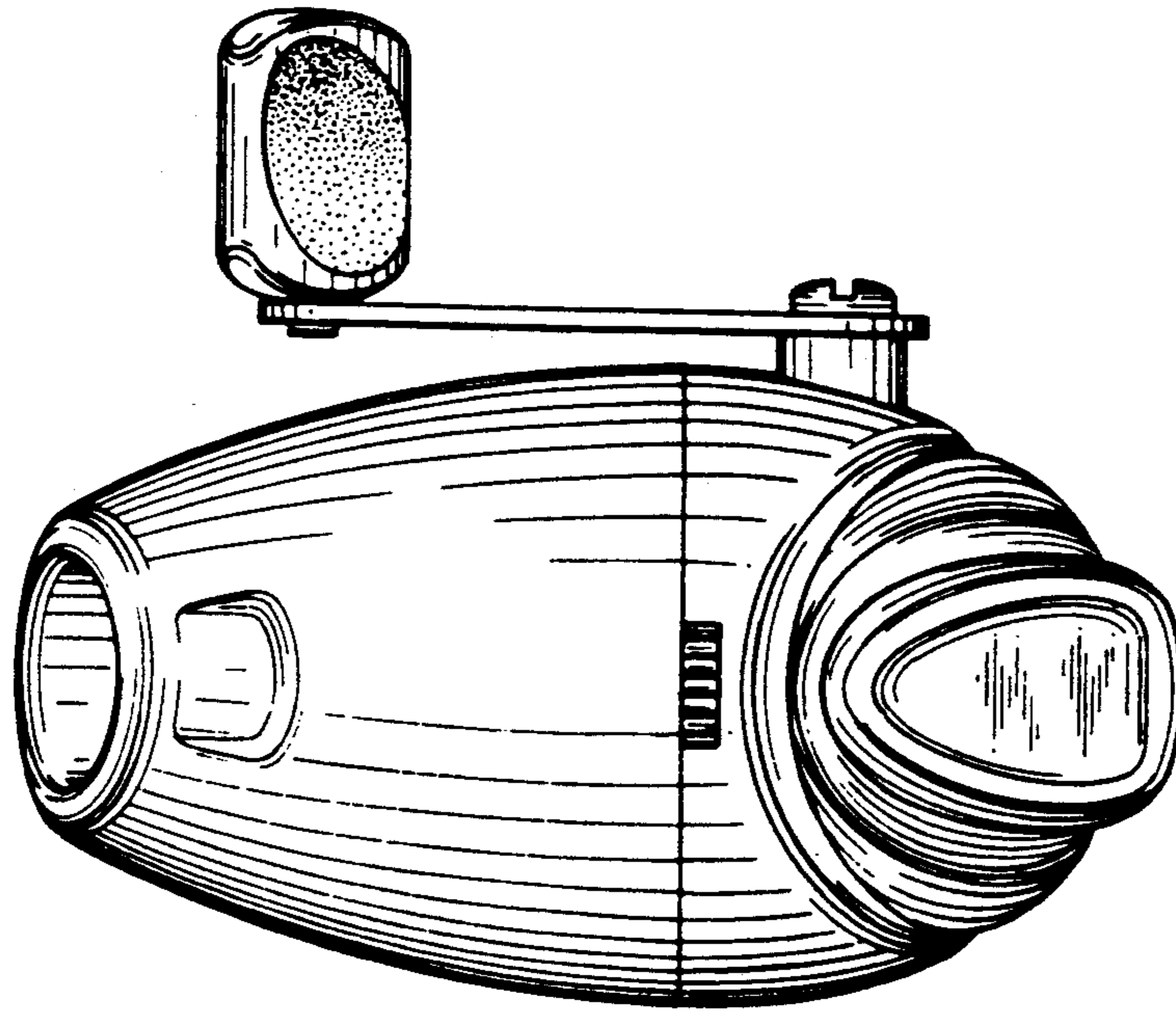

FIG. 7

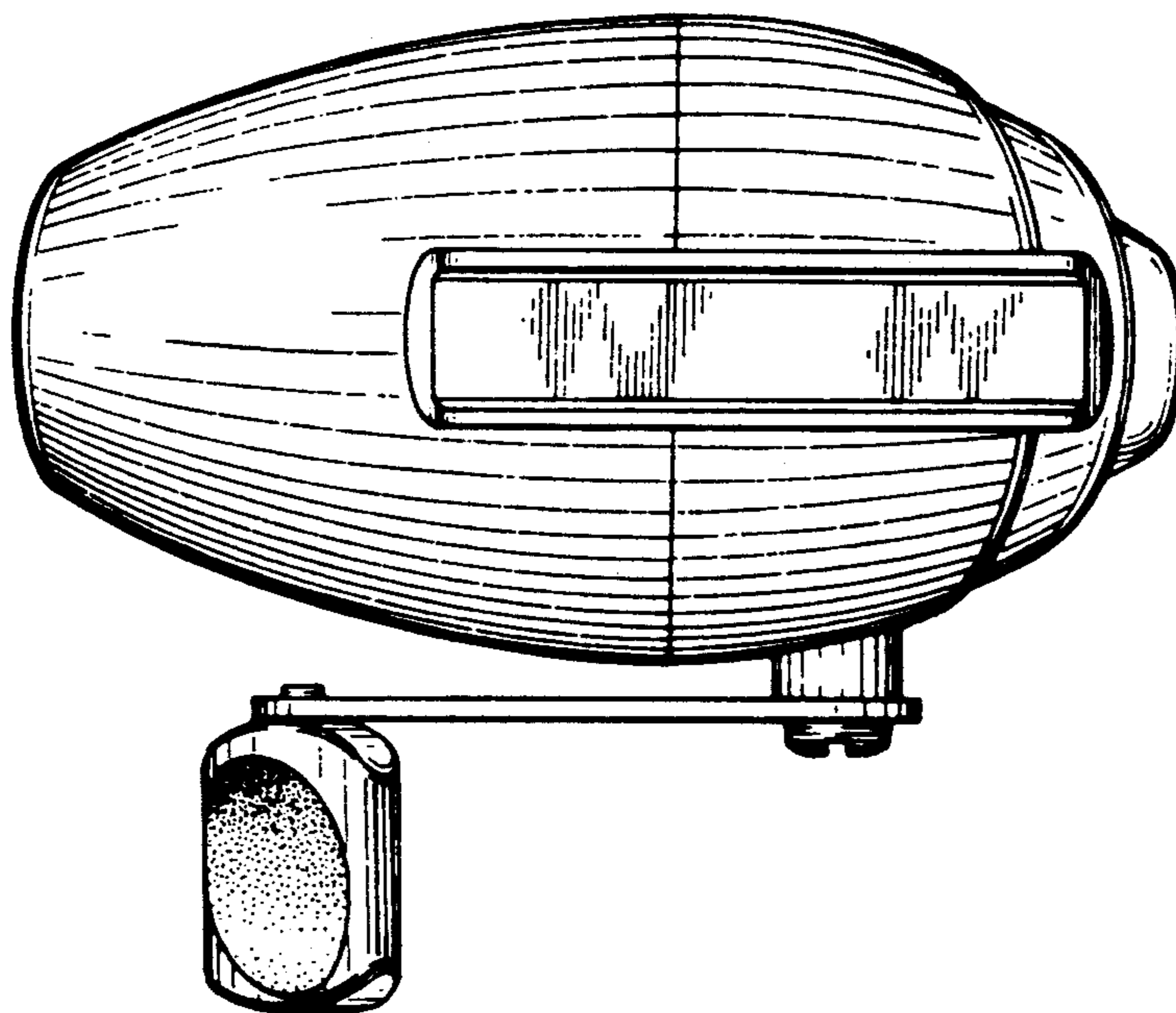

FIG. 8

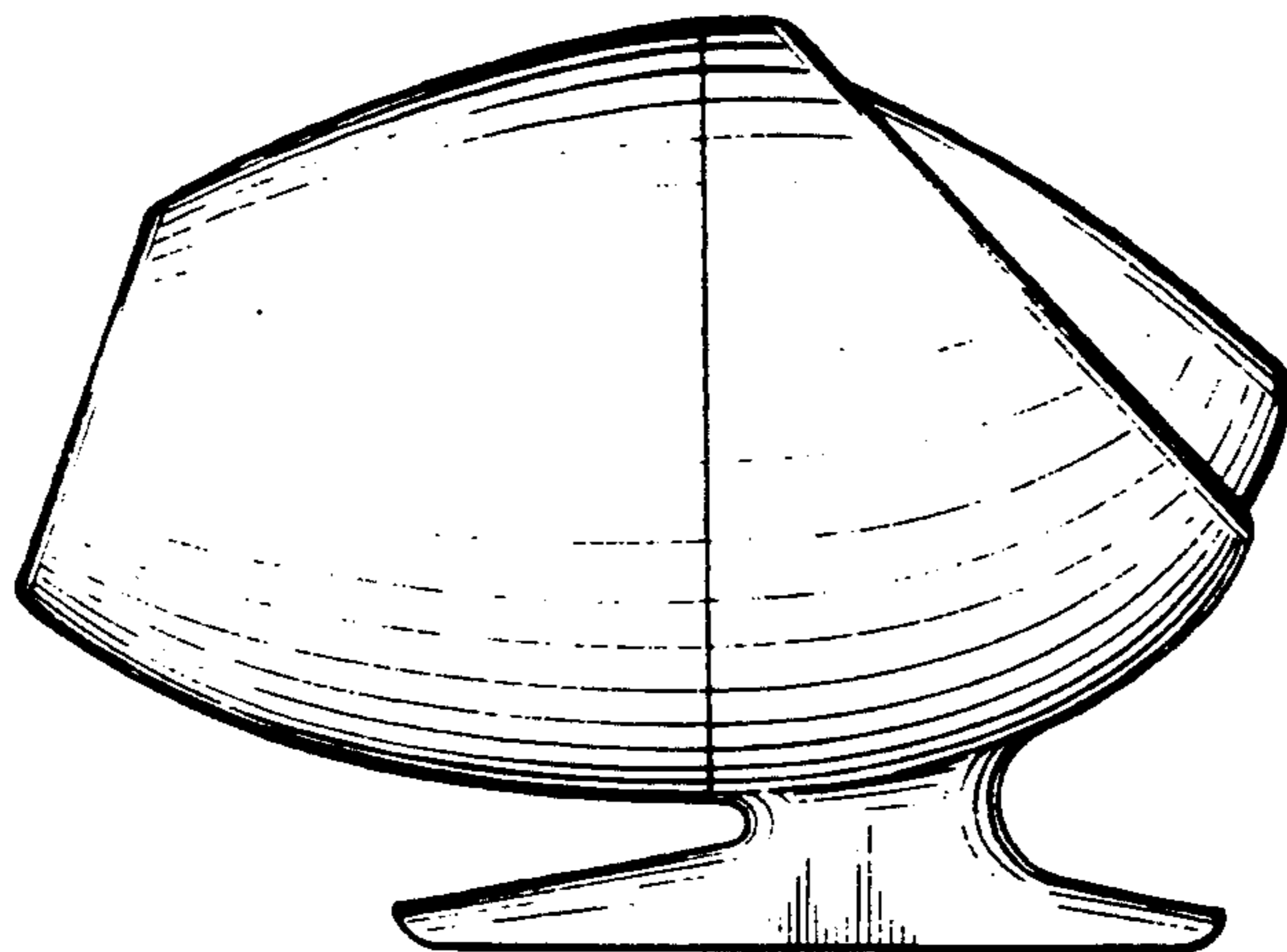

FIG. 9

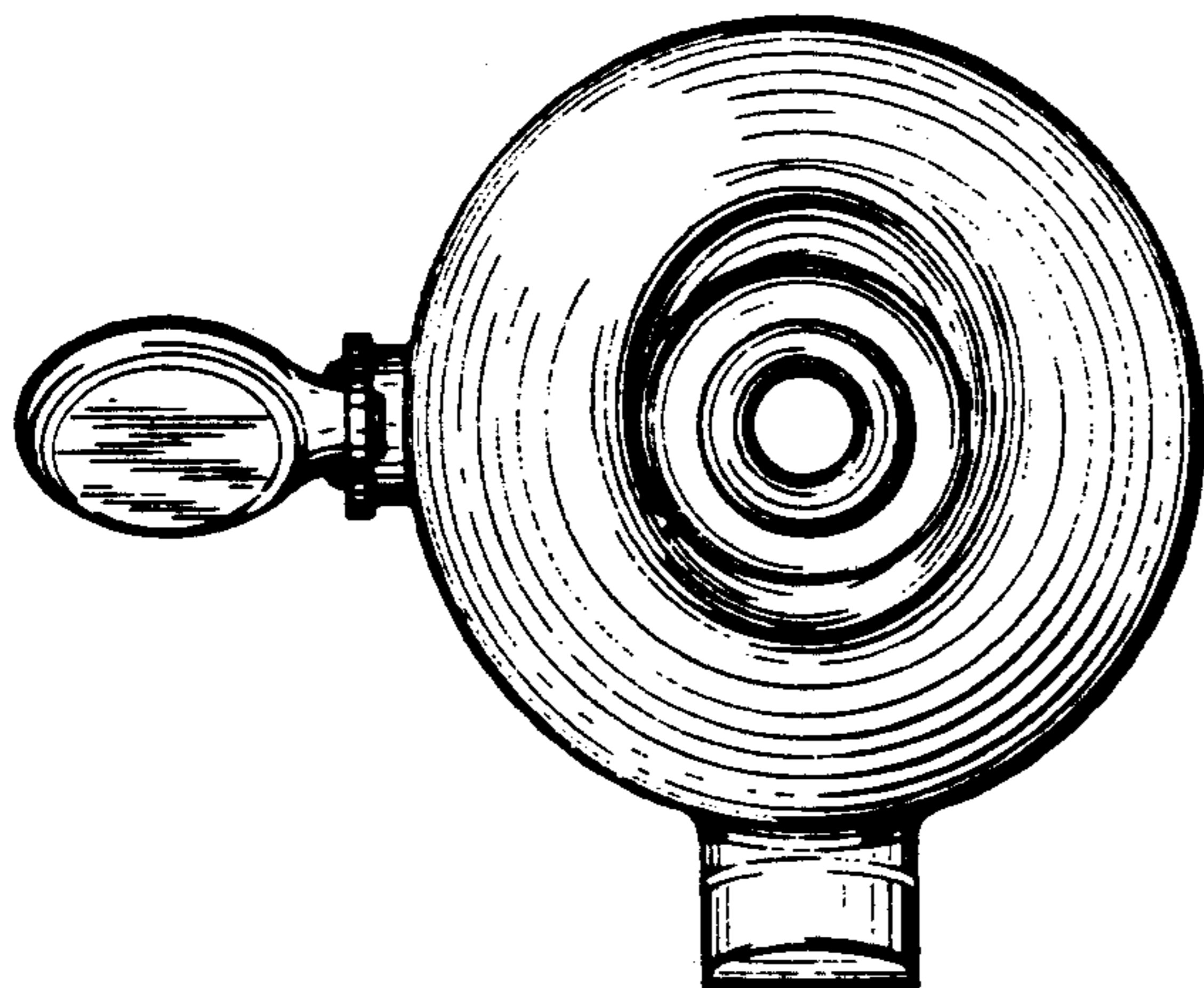

FIG. 10

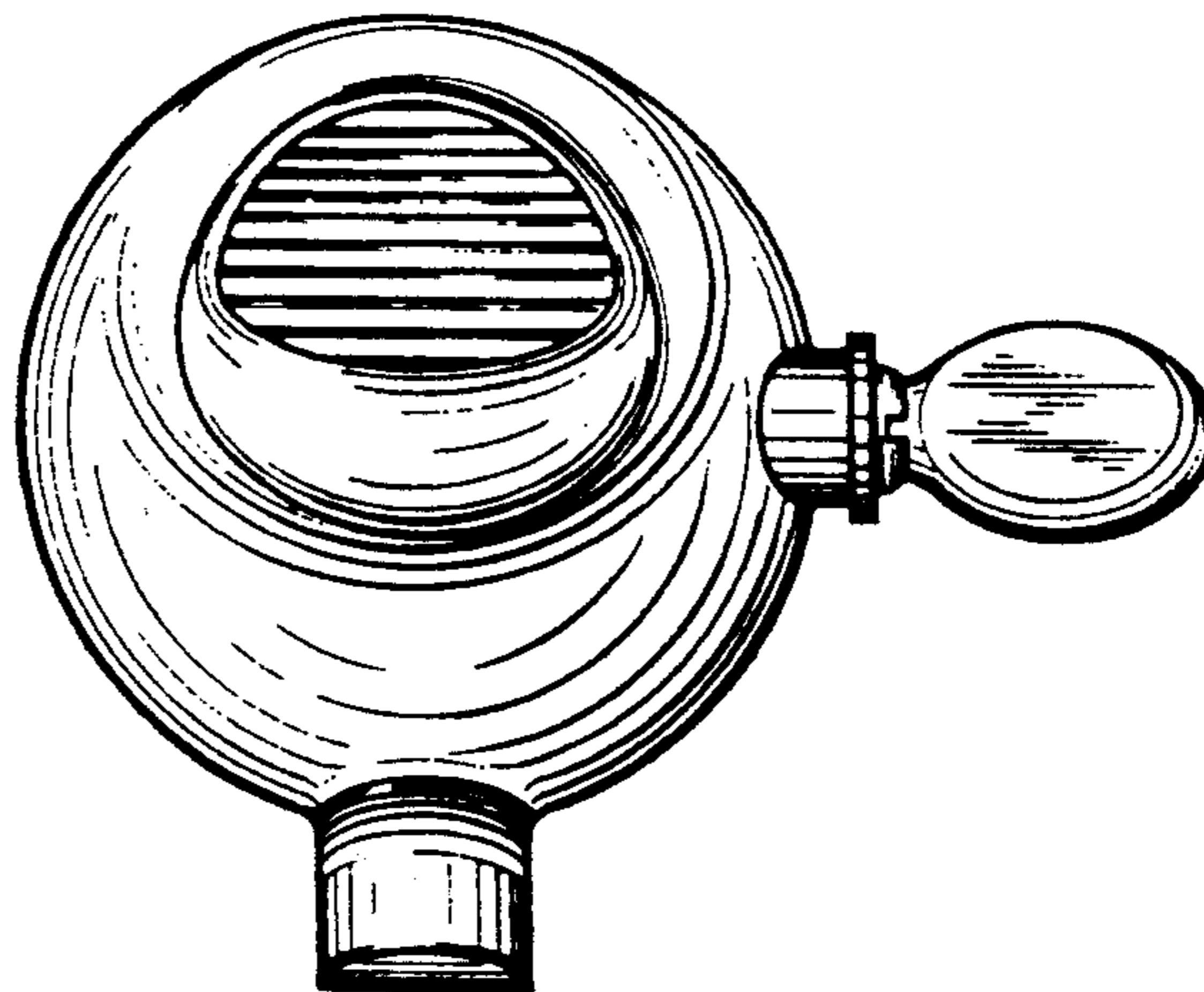

FIG. 11

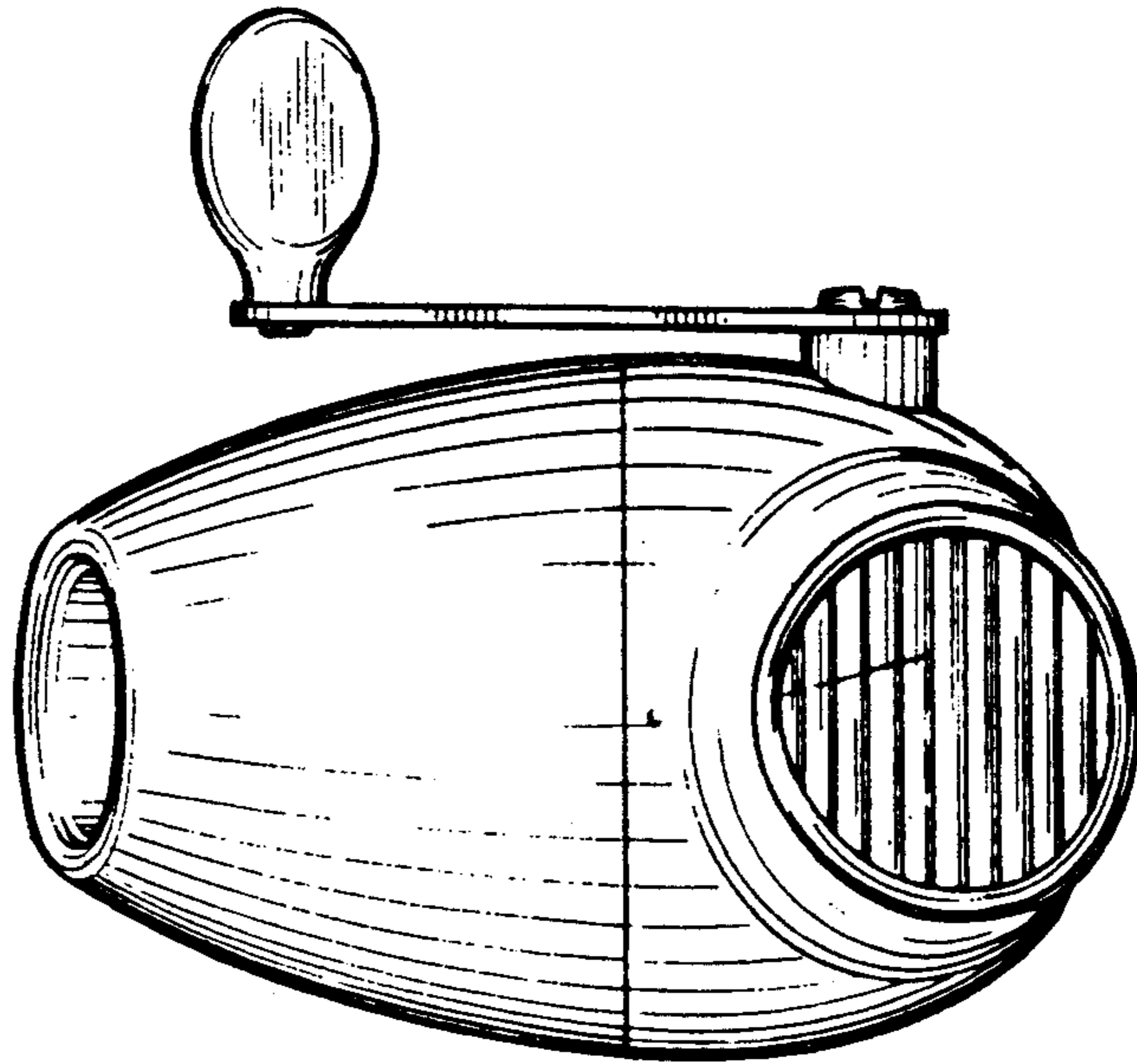

FIG. 12

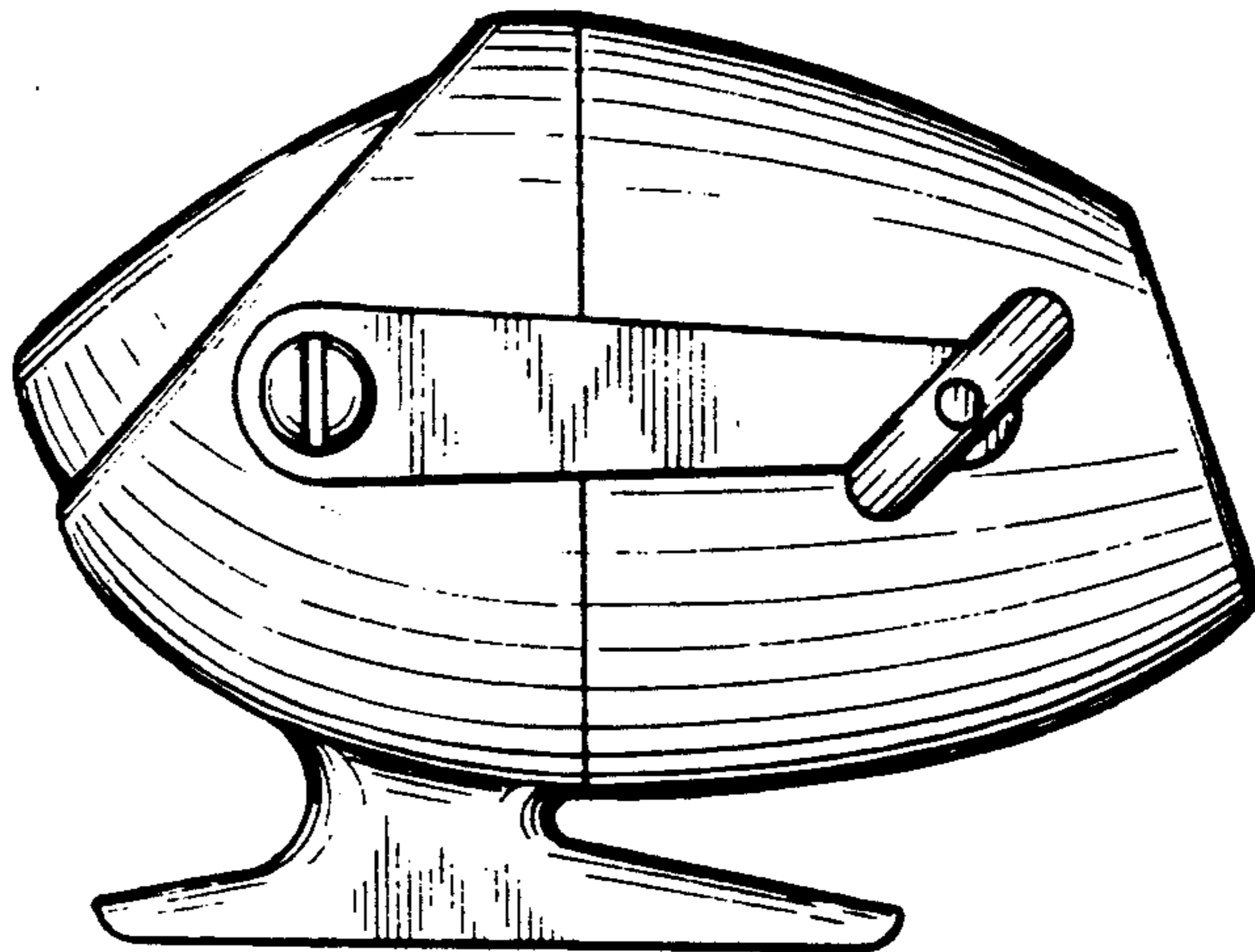

FIG. 13

