



US00D343565S

United States Patent [19]

[11] Patent Number: **Des. 343,565**

Turner

[45] Date of Patent: **** Jan. 25, 1994**

[54] **PORTABLE DOOR LOCK**

4,155,578 5/1979 Rolland 292/292
4,471,981 9/1984 Wright 292/292

[76] Inventor: **Clayton W. Turner, P.O. Box 392,
Reeds Spring, Mo. 65737**

Primary Examiner—Brian N. Vinson
Attorney, Agent, or Firm—Richard C. Litman

[**] Term: **14 Years**

[57] **CLAIM**

[21] Appl. No.: **843,104**

The ornamental design for a portable door lock, as shown and described.

[22] Filed: **Mar. 2, 1992**

[52] U.S. Cl. **D8/331**

DESCRIPTION

[58] Field of Search **D6/330-331,
D6/339-340; 292/289, 292, 295**

FIG. 1 is a front, top and right end perspective view of a portable door lock showing my new design, the portion of the figure shown in broken lines representing a door jamb and forming no part of the claimed design; FIG. 2 is a rear elevational view thereof; FIG. 3 is a right end elevational view thereof; FIG. 4 is a front elevational view thereof; FIG. 5 is a left end elevational view thereof; and, FIG. 6 is a bottom plan view thereof, the top plan view being a mirror image.

[56] **References Cited**

U.S. PATENT DOCUMENTS

D. 213,067	12/1968	Briggs	D8/331
D. 241,115	8/1976	La Barber	D8/331
761,955	6/1904	Glock et al.	292/289
1,128,363	2/1915	Robinson	292/289
2,804,332	8/1957	Franklin	292/292

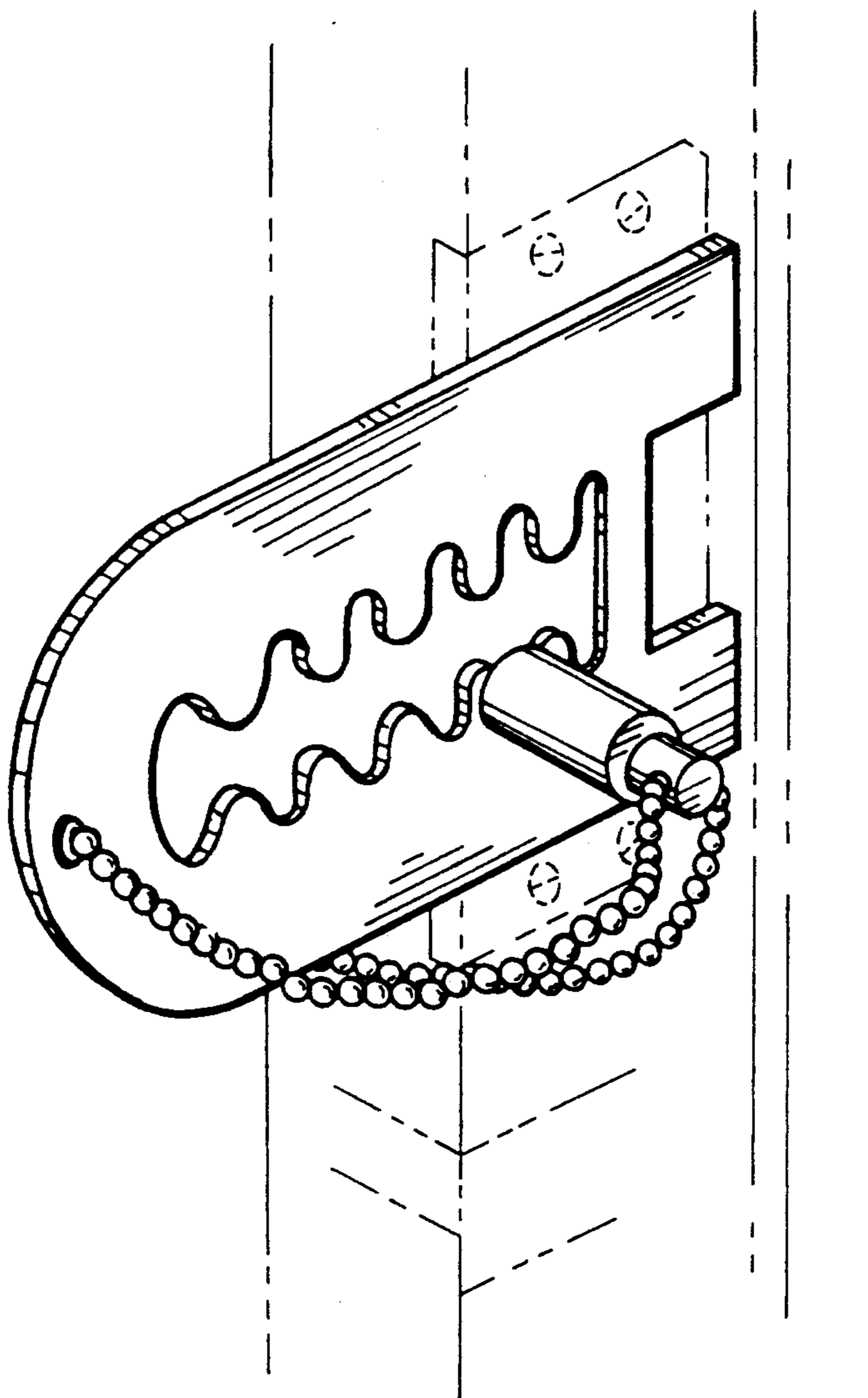

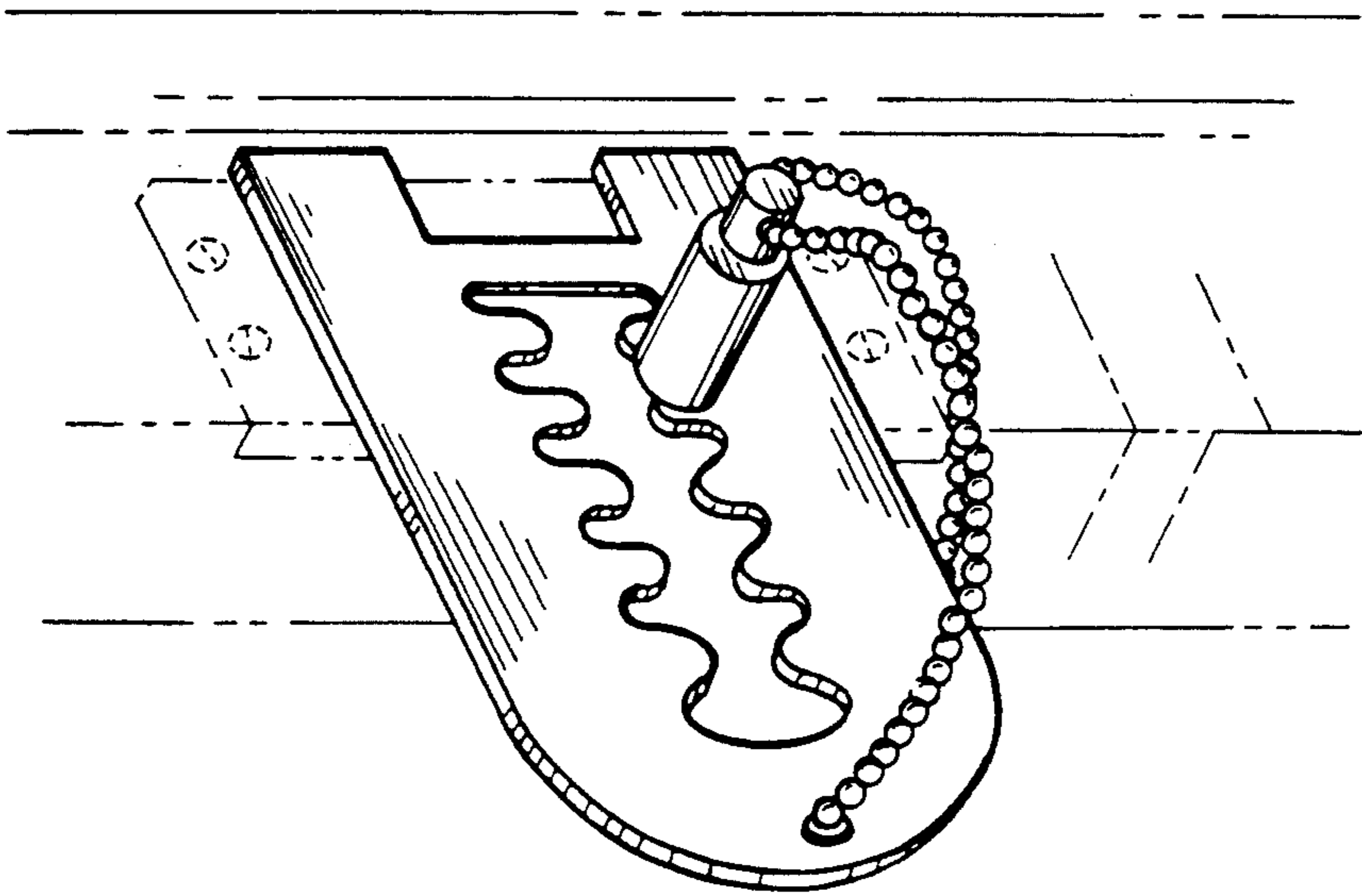

FIG. 1

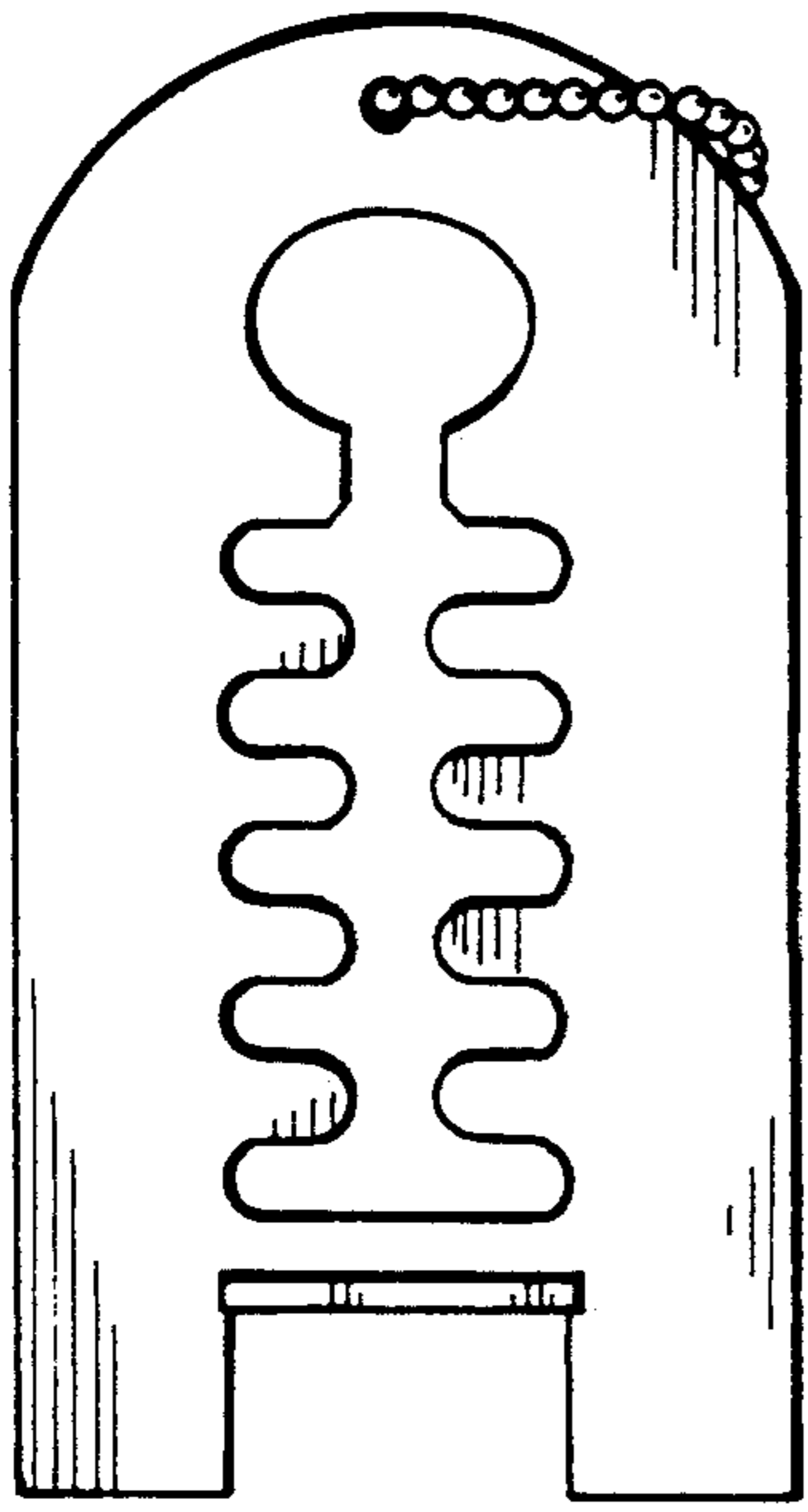

FIG. 2

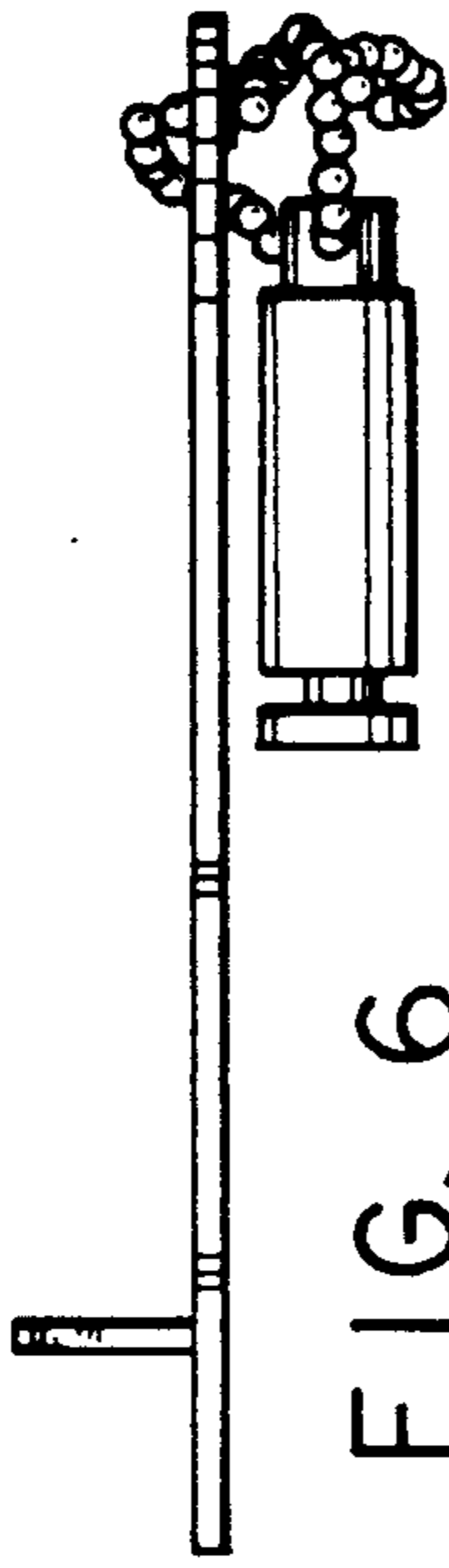

FIG. 6

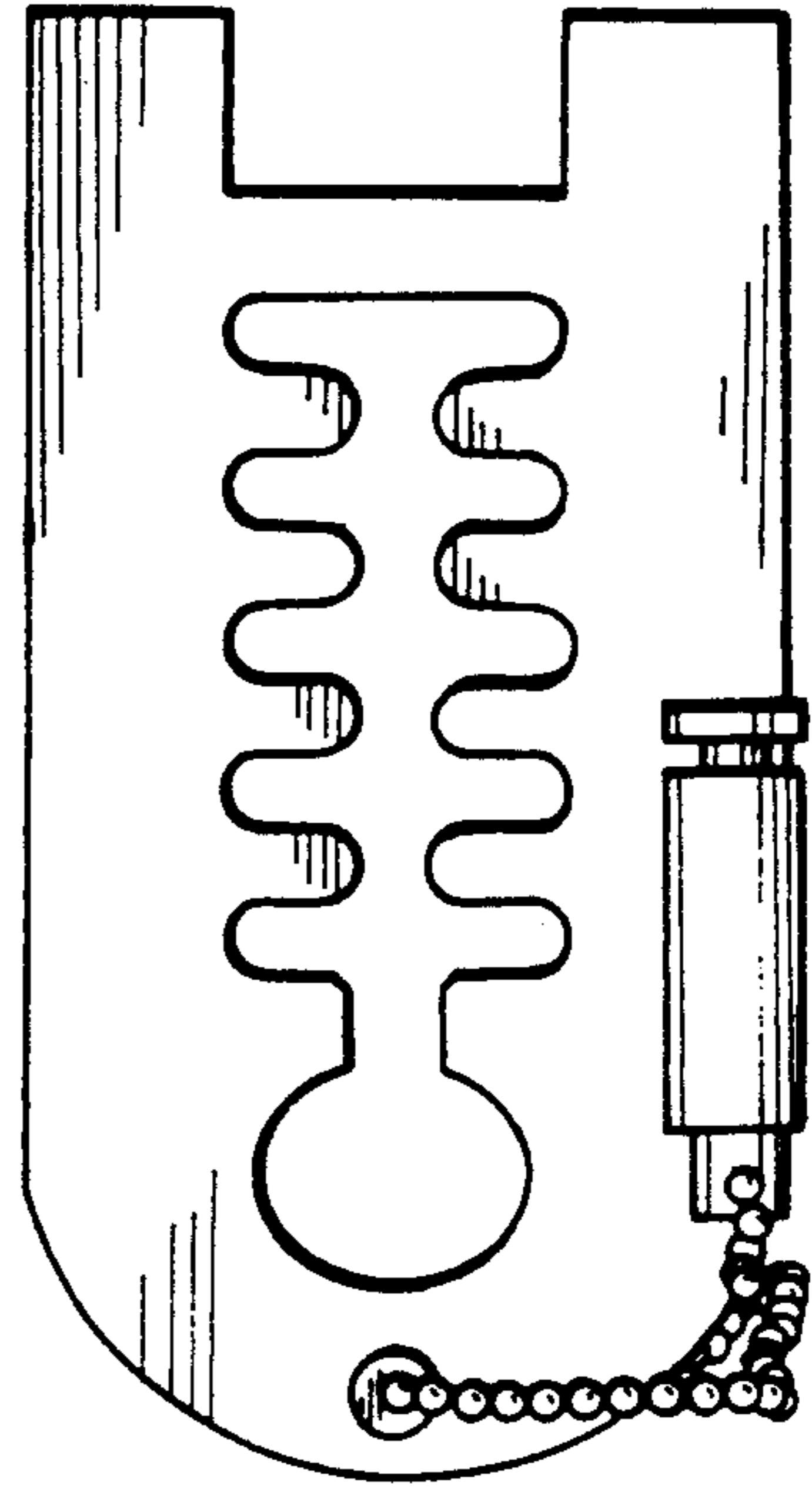

FIG. 4

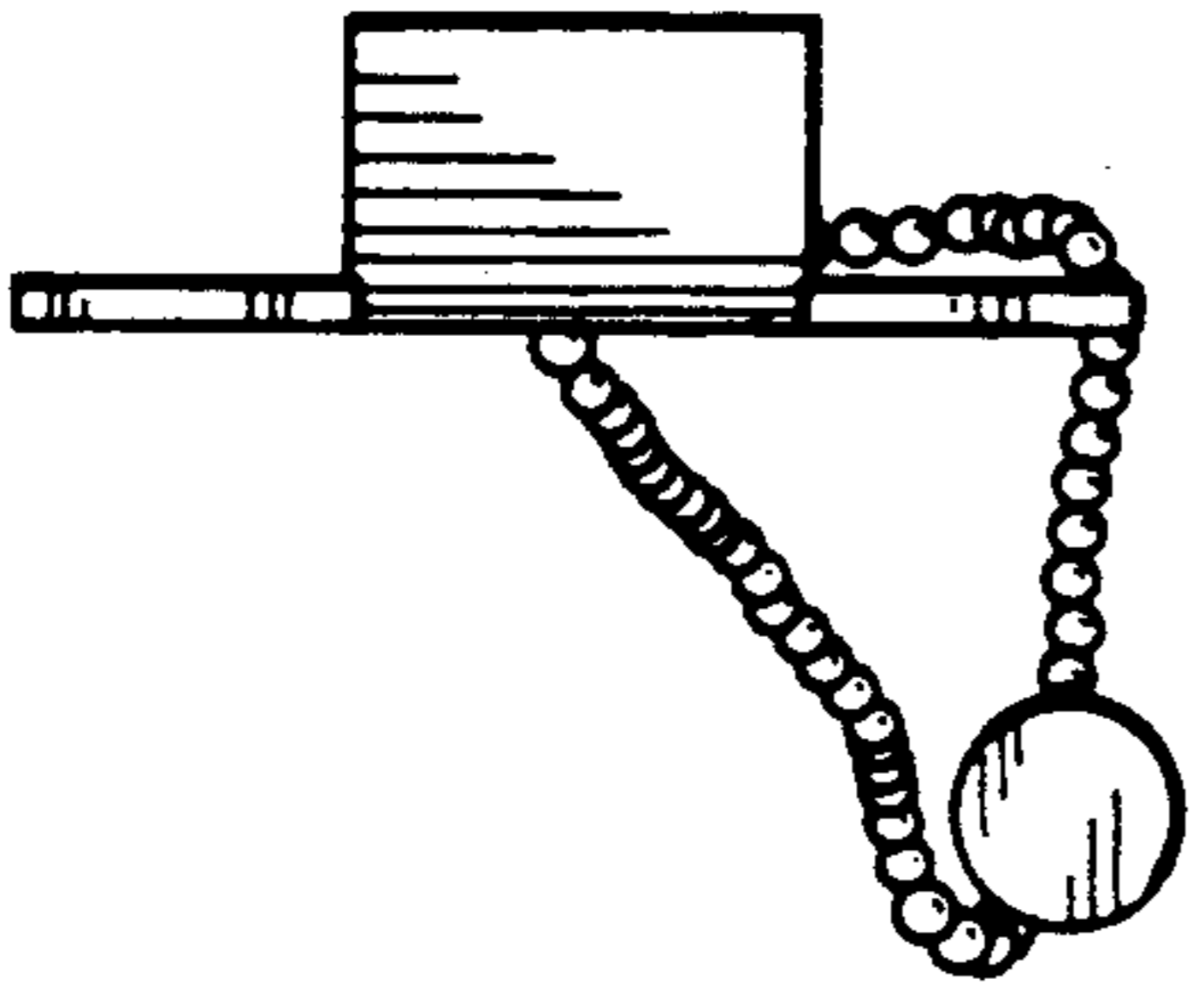

FIG. 3

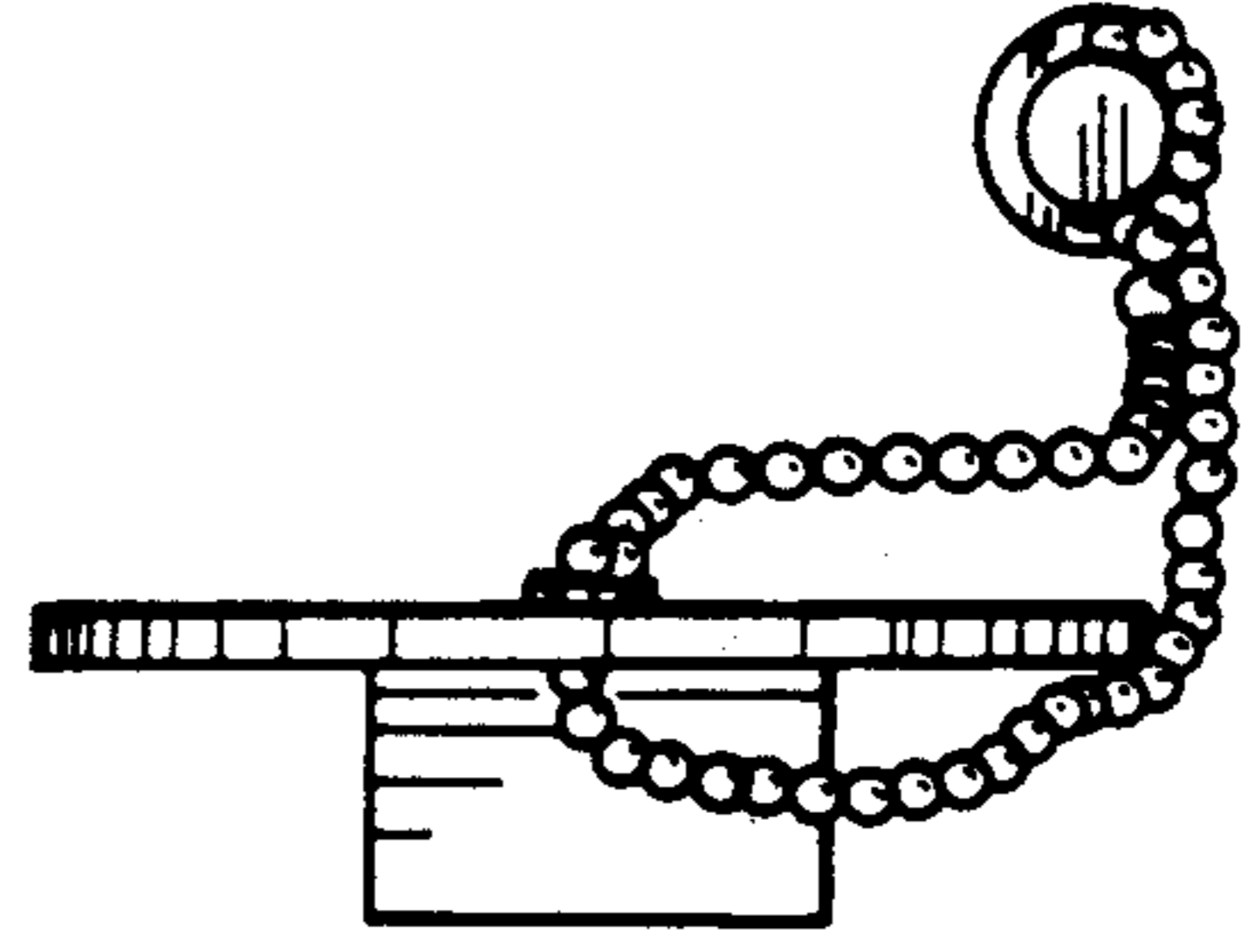

FIG. 5