



US00D343554S

# United States Patent [19]

Watanabe et al.

[11] Patent Number: **Des. 343,554**

[45] Date of Patent: **\*\* Jan. 25, 1994**

[54] **ELECTRIC TRIMMER**

[75] Inventors: **Satoru Watanabe; Masakazu Sakamoto**, both of Tokyo, Japan

[73] Assignee: **Ryobi Ltd.**, Fuchu, Japan

[\*\*] Term: **14 Years**

[21] Appl. No.: **919,567**

[22] Filed: **Jul. 27, 1992**

[30] **Foreign Application Priority Data**

Feb. 5, 1992 [JP] Japan ..... 4-3226

[52] U.S. Cl. .... **D8/8**

[58] Field of Search ..... **D8/8; 30/276**

[56] **References Cited**

**U.S. PATENT DOCUMENTS**

- D. 237,683 11/1975 Behnk et al. .... D8/8
- D. 251,699 5/1979 Averitt ..... D8/8
- D. 251,960 5/1979 Averitt .
- D. 256,769 9/1980 Irelan ..... D8/8
- D. 264,042 4/1982 Inaga et al. .... D8/8
- D. 307,860 5/1990 Ellis ..... D8/8
- D. 317,852 7/1991 Fujiwara et al. .
- D. 336,223 6/1993 Miyamoto et al. .... D8/8

**FOREIGN PATENT DOCUMENTS**

675777 4/1986 Japan .

**OTHER PUBLICATIONS**

Paramount Brochure, Jan. 13, 1986, p. 2 weeders, all models located in center of page.

Weed Eater Brochure, 1986, p. 2, electric trimmers, both models, located at right of page.

The Green Machine brochure, Aug. 10, 1987, no page number, electric trimmer item A, located at left side of page.

Japanese Catalog Mar. 1986, electric trimmer, item A at right of page.

*Primary Examiner*—Wallace R. Burke

*Assistant Examiner*—H. Baynham

*Attorney, Agent, or Firm*—Sughrue, Mion, Zinn, Macpeak & Seas

[57] **CLAIM**

The ornamental design for an electric trimmer, as shown.

**DESCRIPTION**

FIG. 1 is a front, top and right side perspective view of an electric trimmer showing our new design;  
 FIG. 2 is a front elevational view thereof;  
 FIG. 3 is a rear elevational view thereof;  
 FIG. 4 is a right side elevational view thereof;  
 FIG. 5 is a top plan view thereof;  
 FIG. 6 is a left side elevational view thereof; and,  
 FIG. 7 is a bottom plan view thereof.

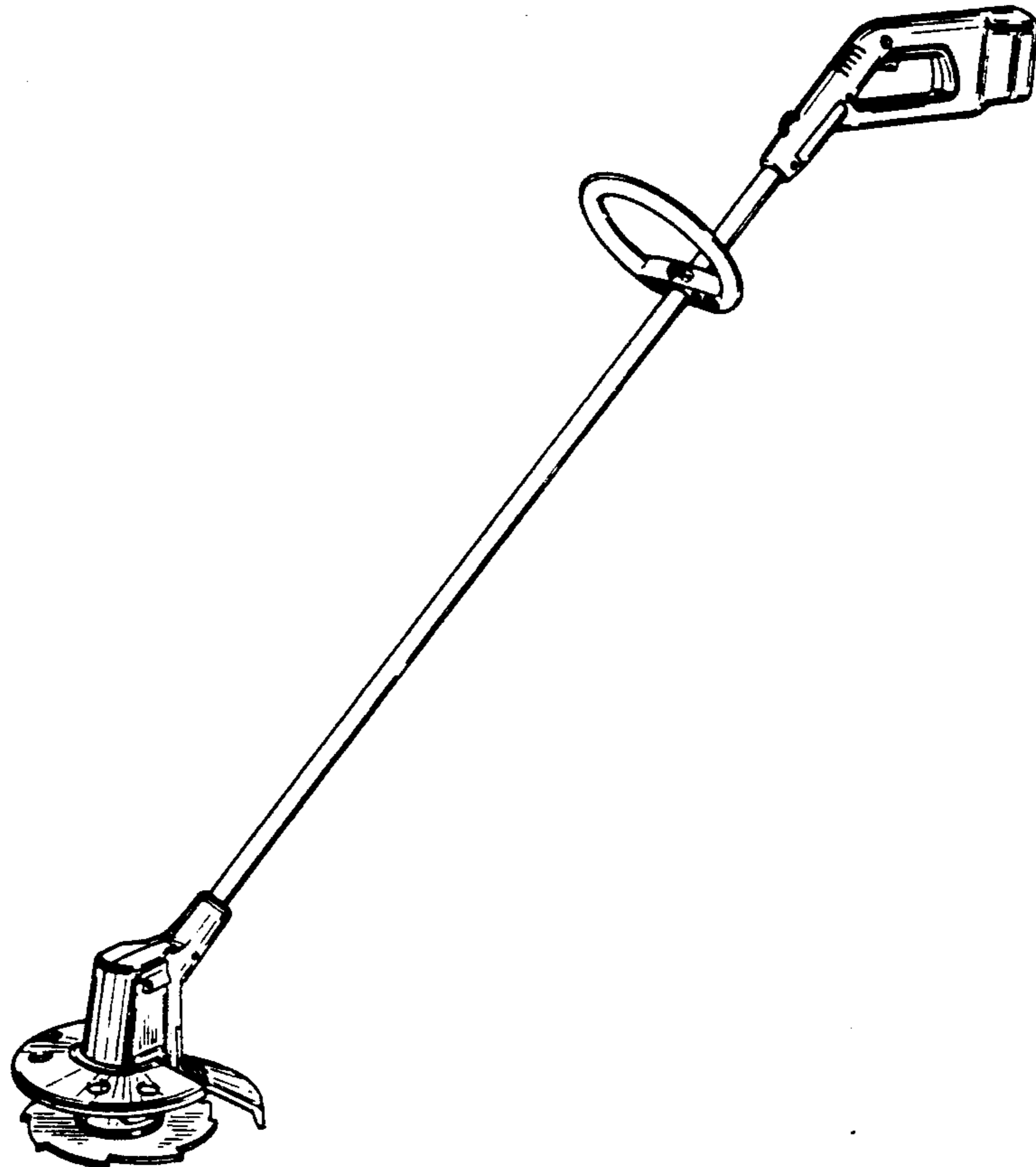

FIG. 1

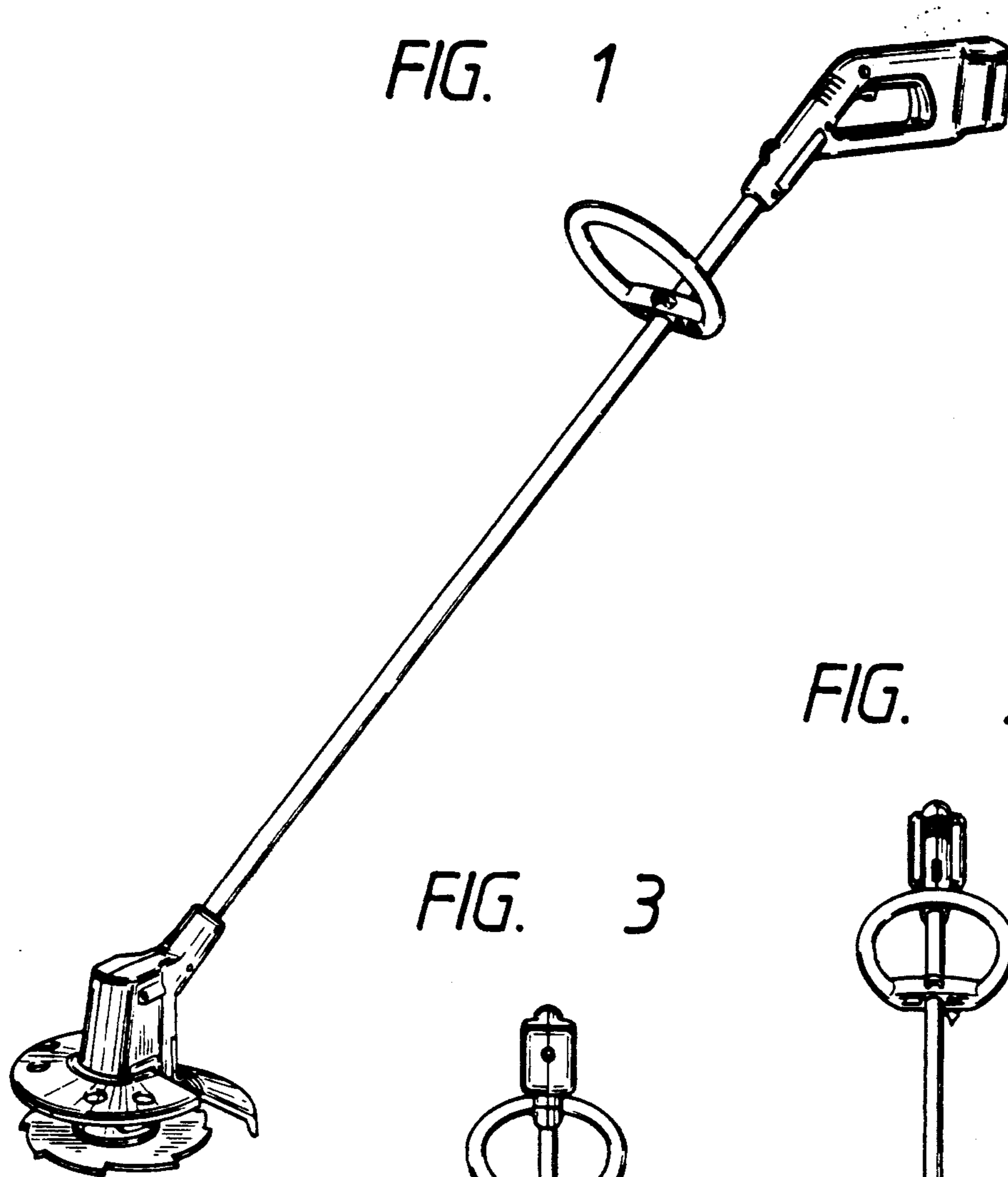

FIG. 2

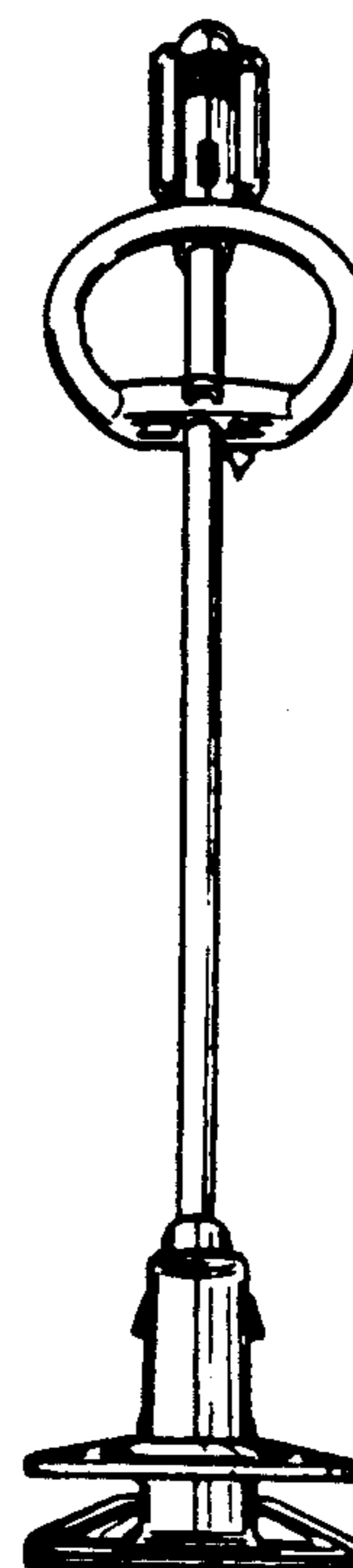

FIG. 3

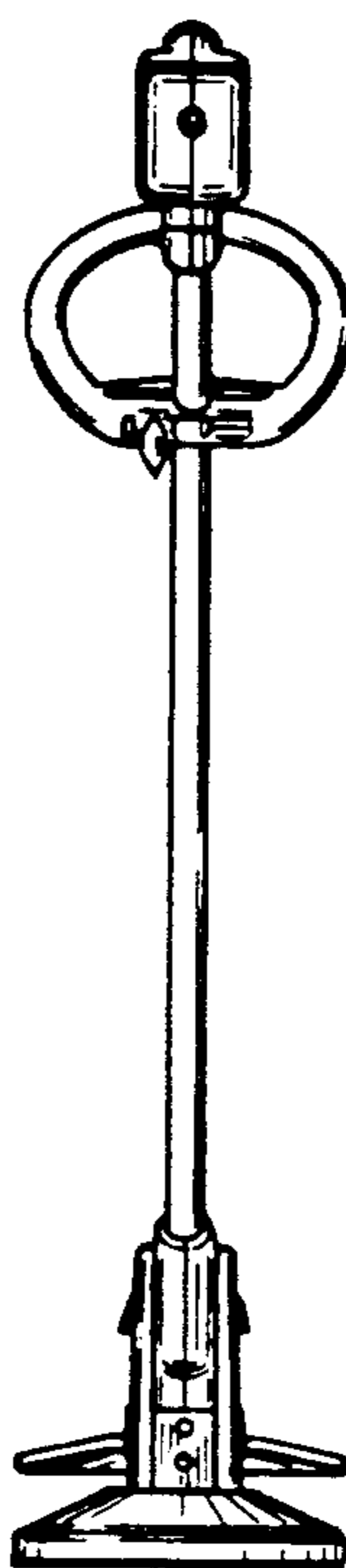

FIG. 4

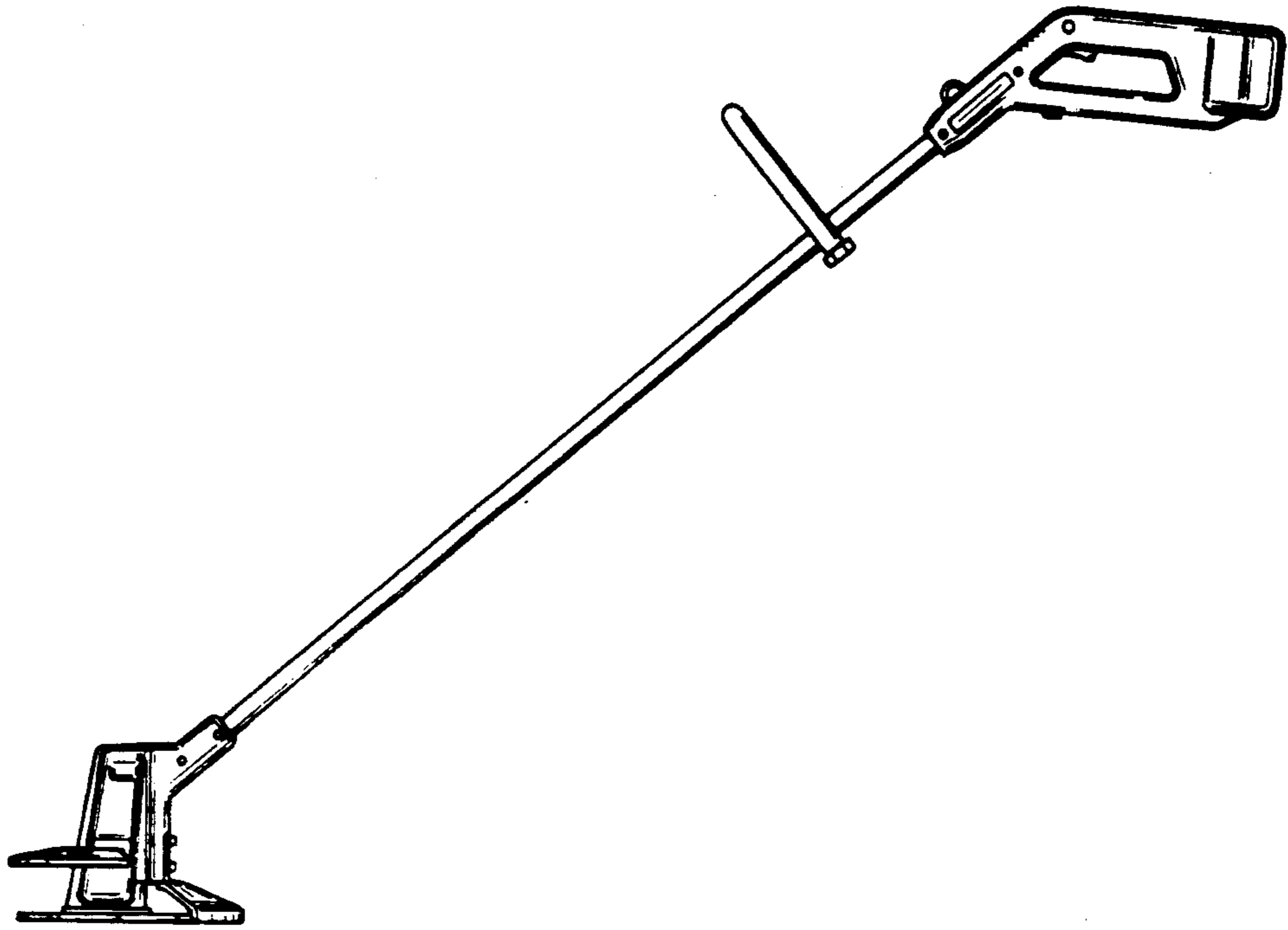

FIG. 5

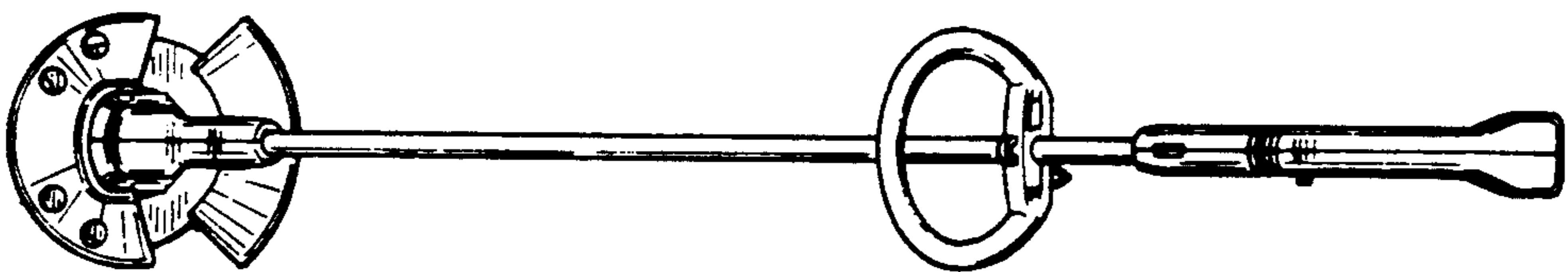

FIG. 6

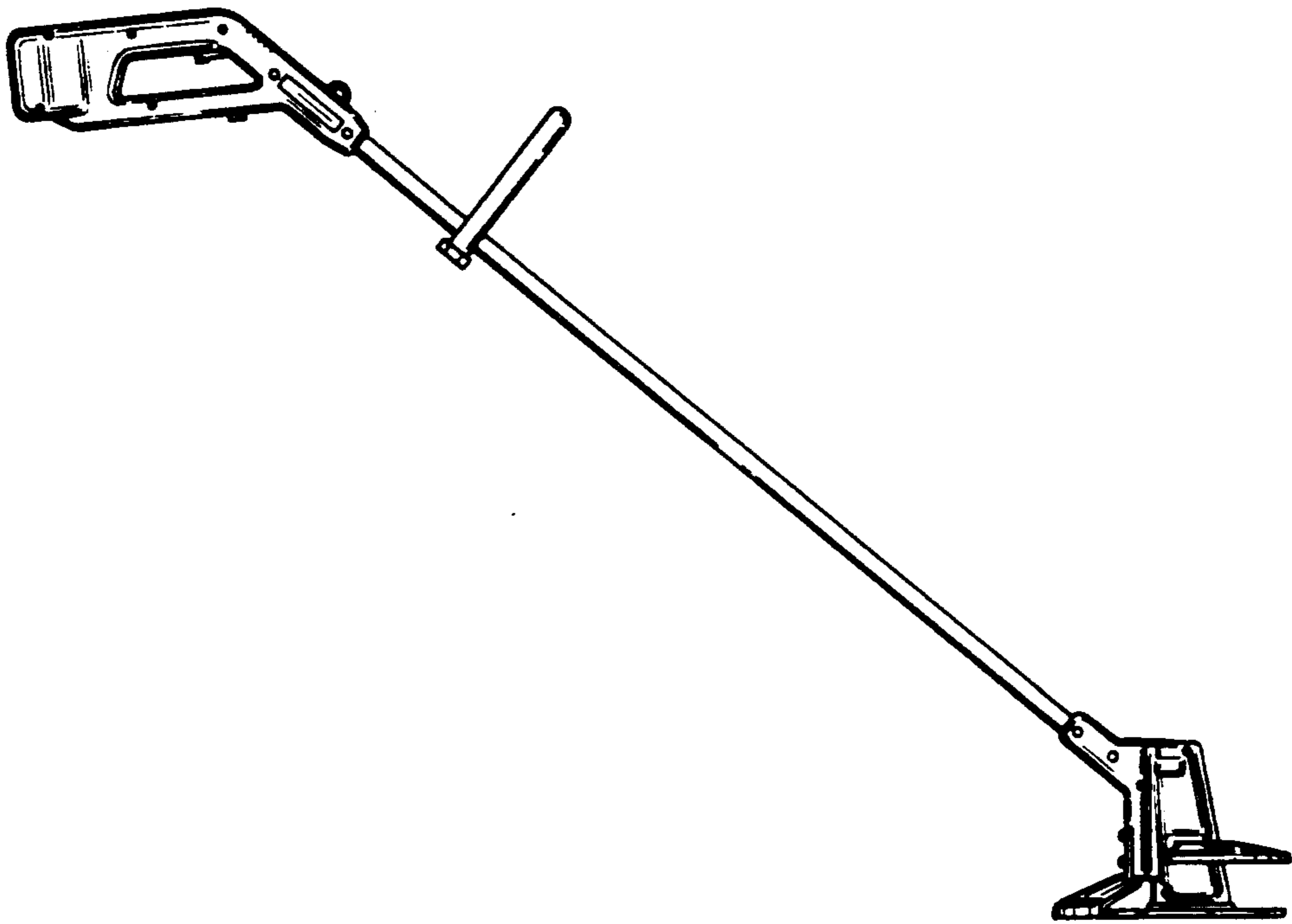

FIG. 7

