



US00D343512S

# United States Patent [19]

[11] Patent Number: **Des. 343,512**

Tse

[45] Date of Patent: **\*\* Jan. 25, 1994**

[54] **STORAGE BOX FOR DISKETTES**

[75] Inventor: **Michael K.-M. Tse, Kowloon, Hong Kong**

[73] Assignee: **STD Electronic International Ltd., Kowloon, Hong Kong**

[\*\*] Term: **14 Years**

[21] Appl. No.: **899,637**

[22] Filed: **Jun. 16, 1992**

[30] **Foreign Application Priority Data**

Jan. 16, 1992 [GB] United Kingdom ..... 2020320

[52] U.S. Cl. .... **D3/35; D3/74; D19/75**

[58] Field of Search ..... **D3/30.1, 35, 74; D9/341, 423, 432; 206/387, 425, 444, 562, 563, 564; 312/9.54; D19/75, 76**

[56] **References Cited**

**U.S. PATENT DOCUMENTS**

D. 219,369 12/1970 Silversteni ..... D3/35

- D. 250,552 12/1978 Winther ..... D3/35
- D. 258,027 1/1981 Rathe et al. .... D3/35
- D. 267,370 12/1982 Cline ..... D3/73
- D. 285,216 8/1986 Roskovist ..... D19/76
- D. 318,758 8/1991 Mervar et al. .... D19/76

*Primary Examiner*—A. Hugo Word  
*Assistant Examiner*—Celia A. Murphy  
*Attorney, Agent, or Firm*—Burns, Doane, Swecker & Mathis

[57] **CLAIM**

The ornamental design for a storage box for diskettes, as shown and described.

**DESCRIPTION**

FIG. 1 is a top front perspective view of a storage box for diskettes showing my new design;  
FIG. 2 is a front elevational view thereof shown in a closed position;  
FIG. 3 is a rear elevational view of FIG. 2;  
FIG. 4 is a left side elevational view of FIG. 2;  
FIG. 5 is a right side elevational view of FIG. 2;  
FIG. 6 is a top plan view of FIG. 2; and,  
FIG. 7 is a bottom plan view of FIG. 2.

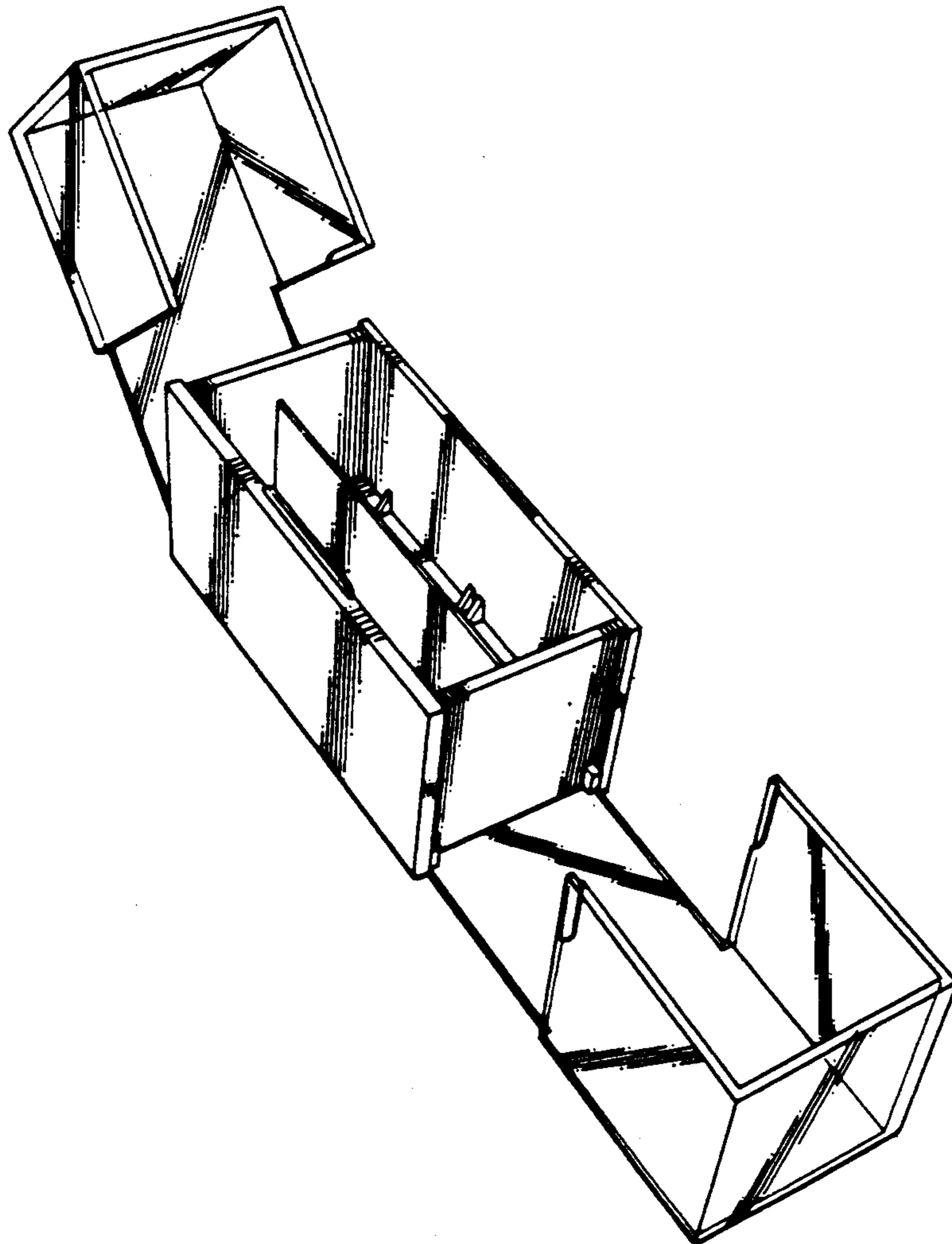

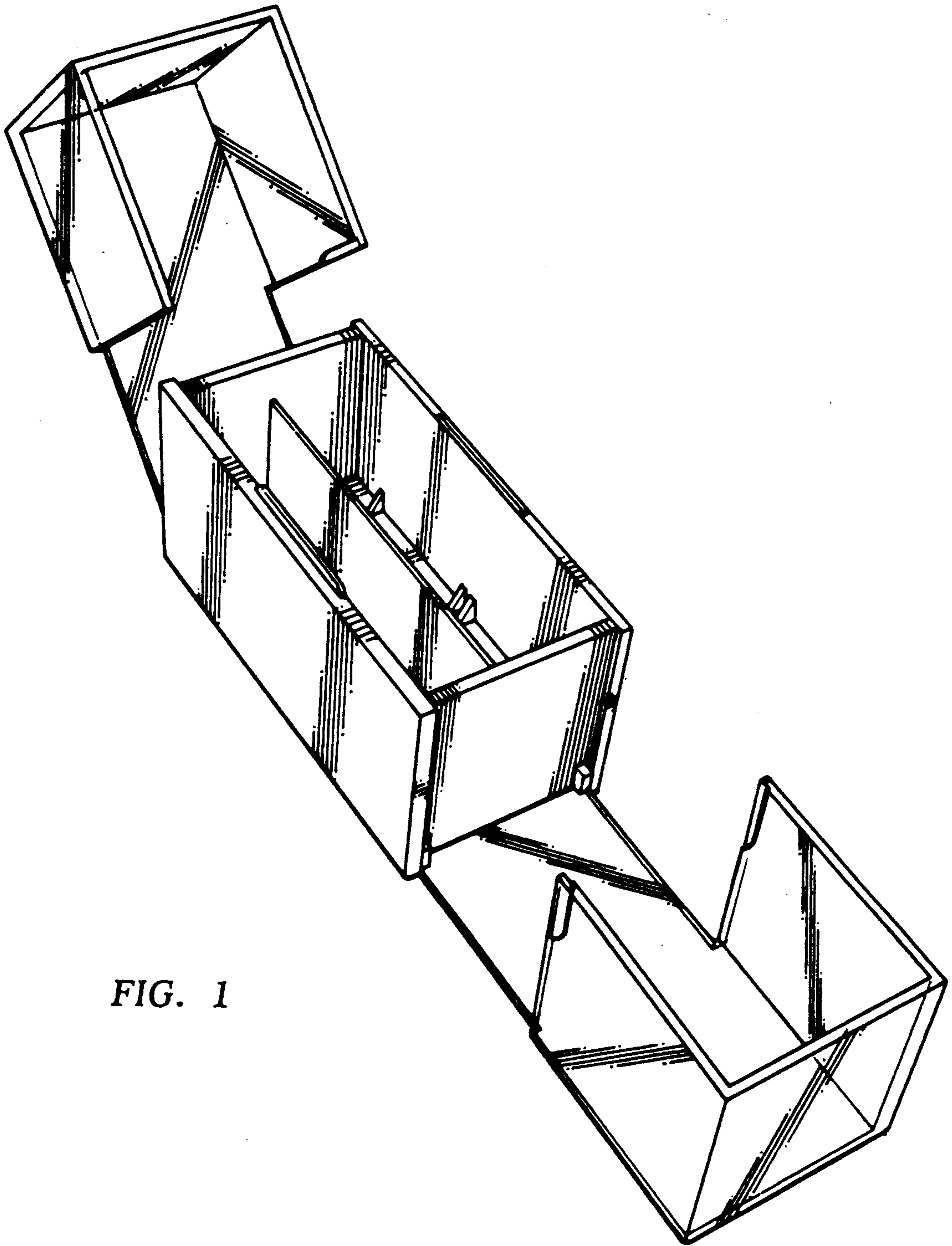

FIG. 1

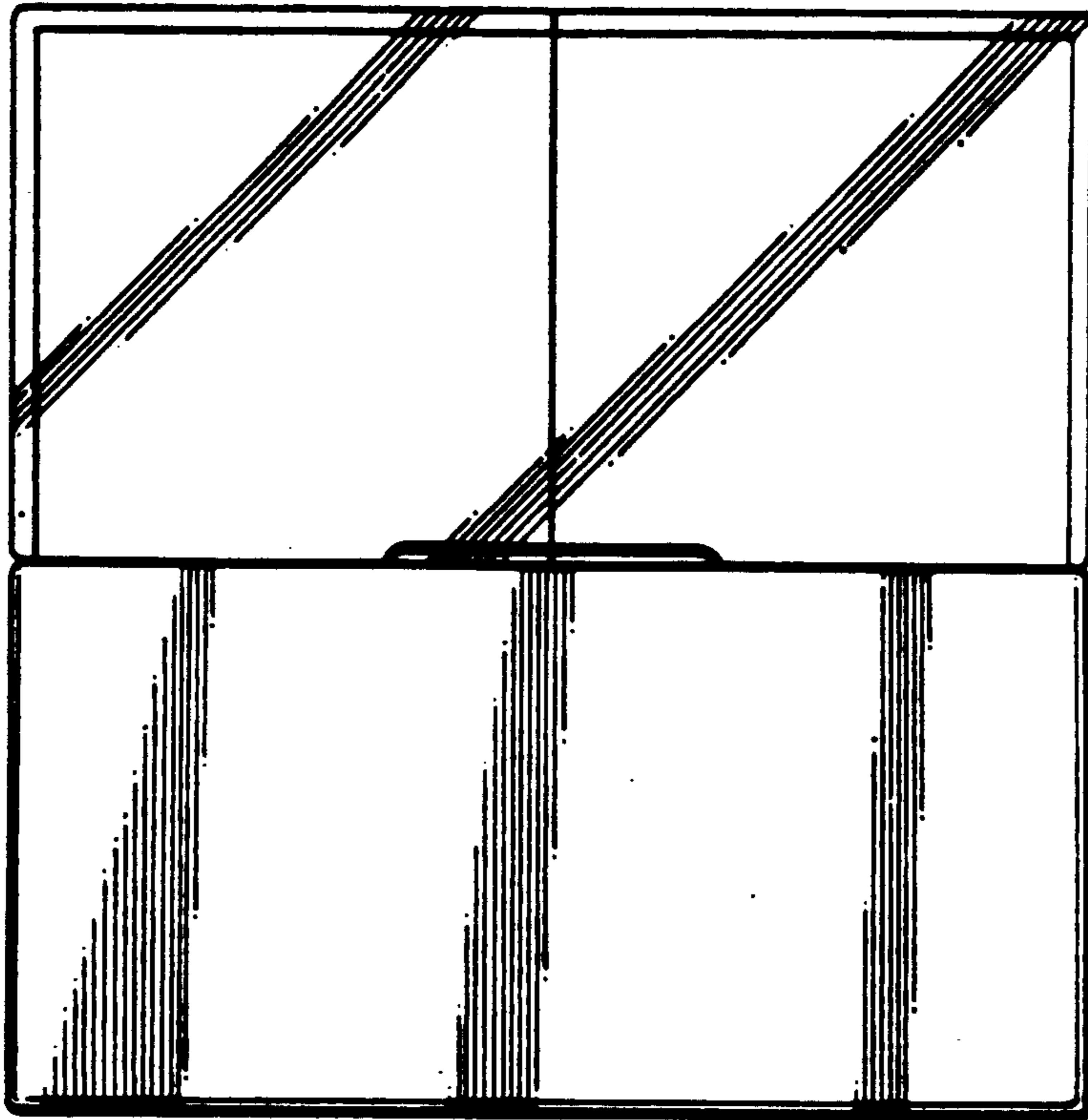

FIG. 2

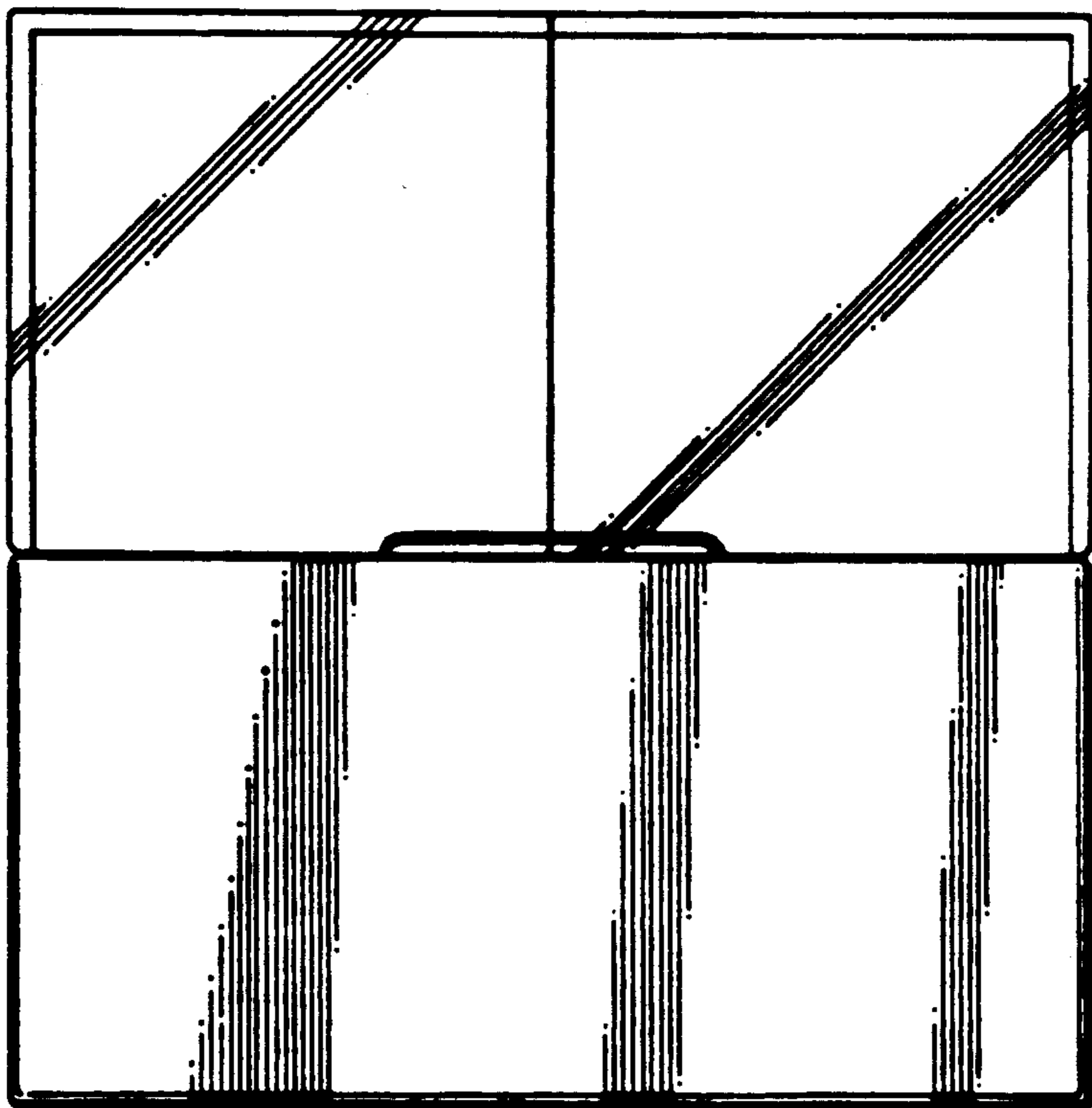

FIG. 3

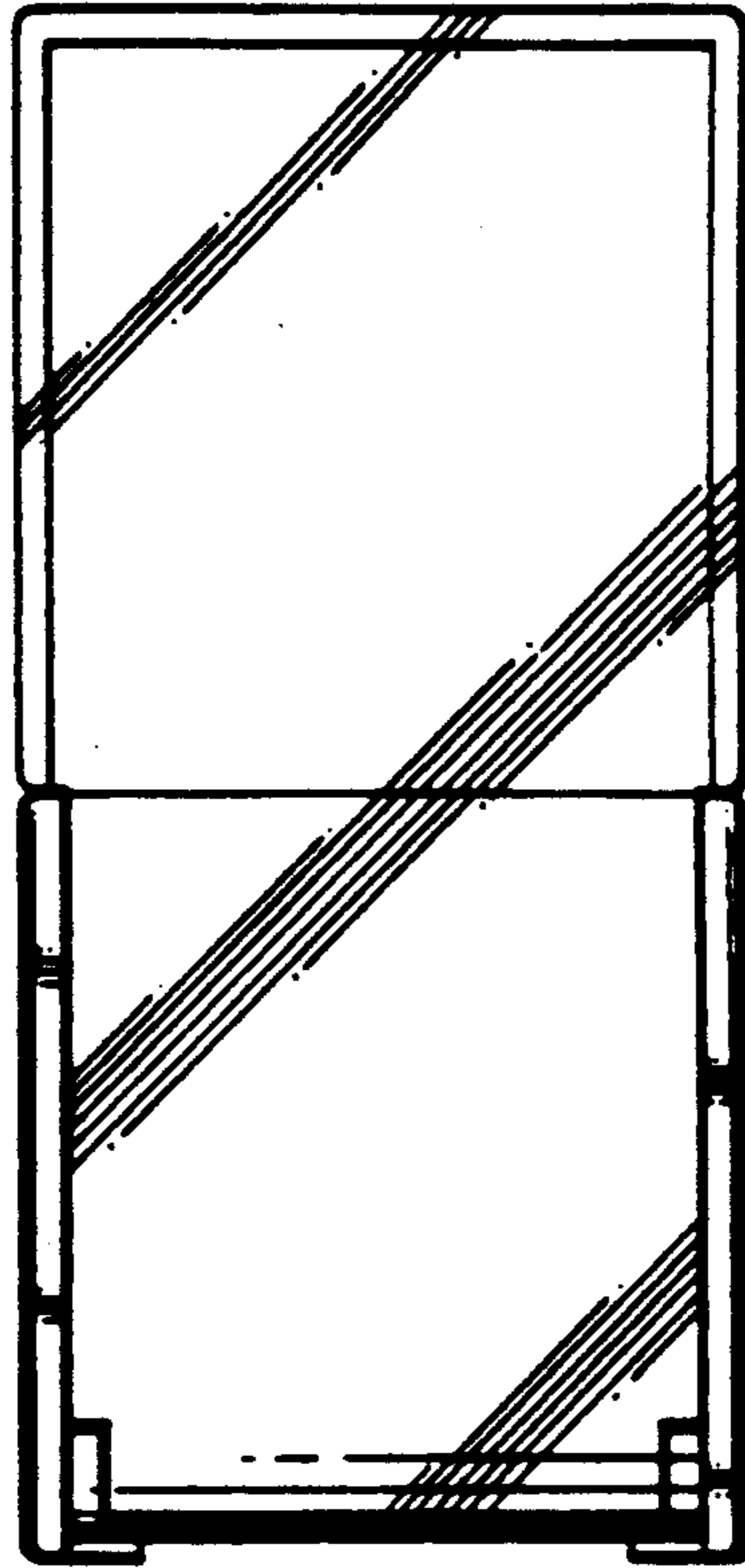

FIG. 4

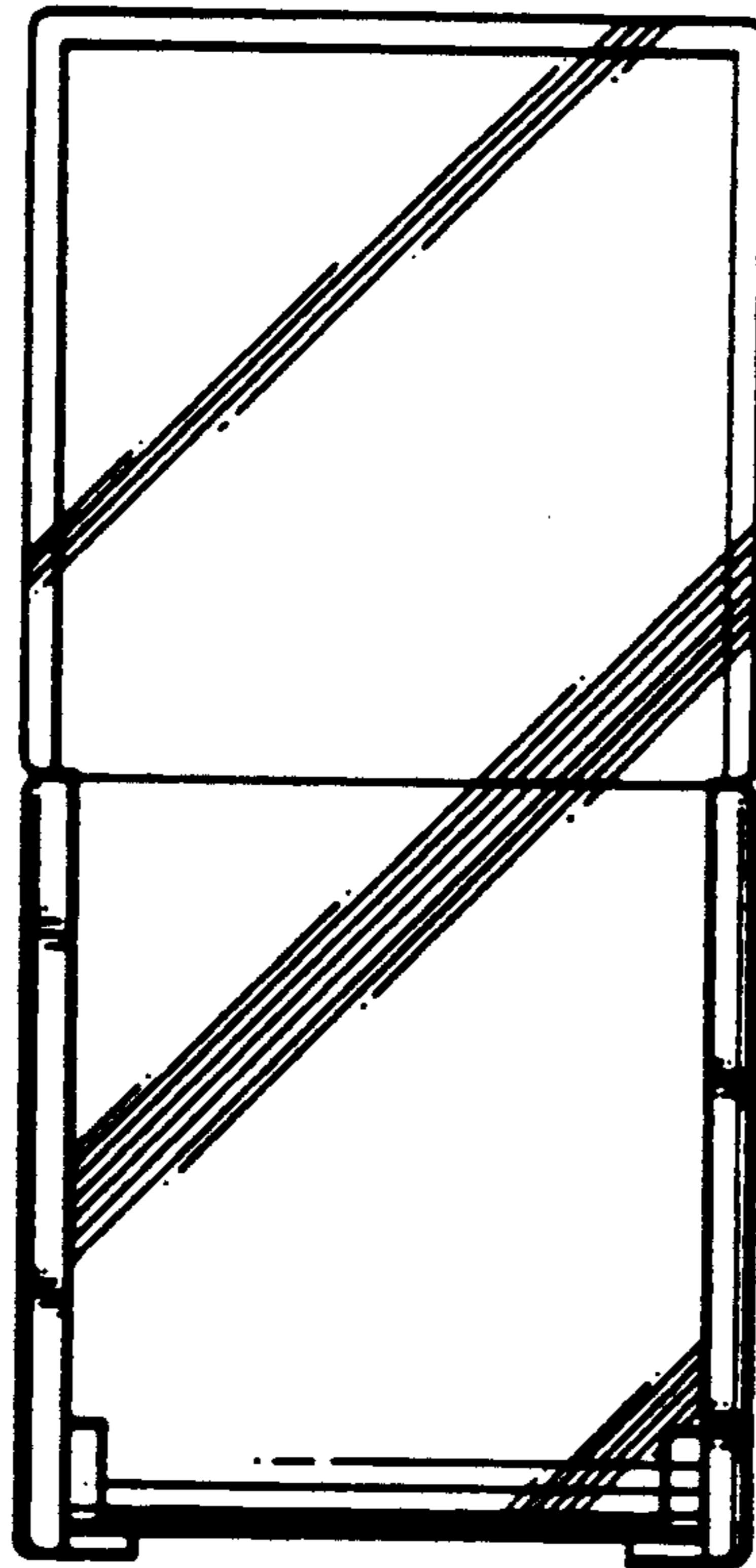

FIG. 5



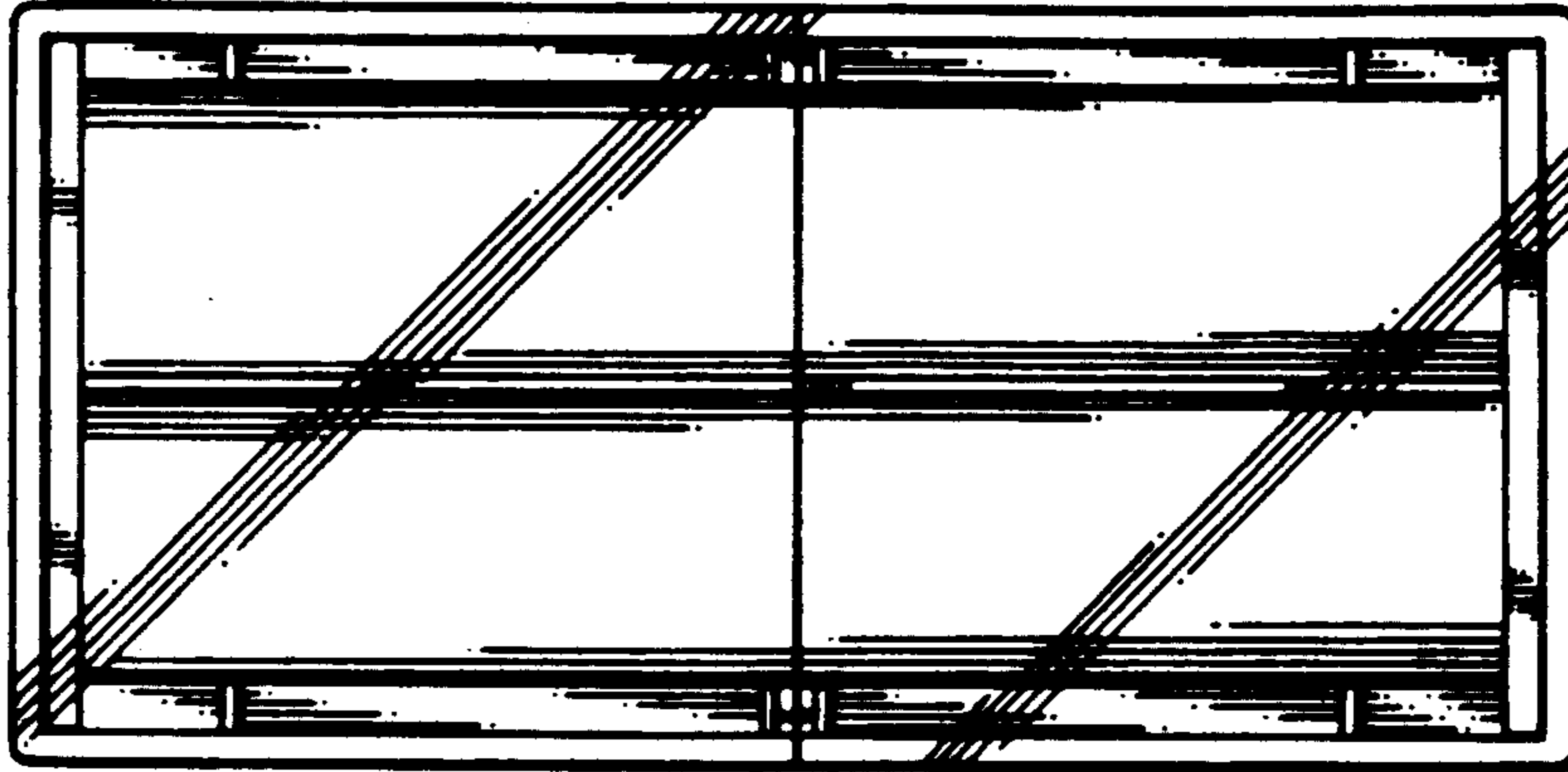

FIG. 6

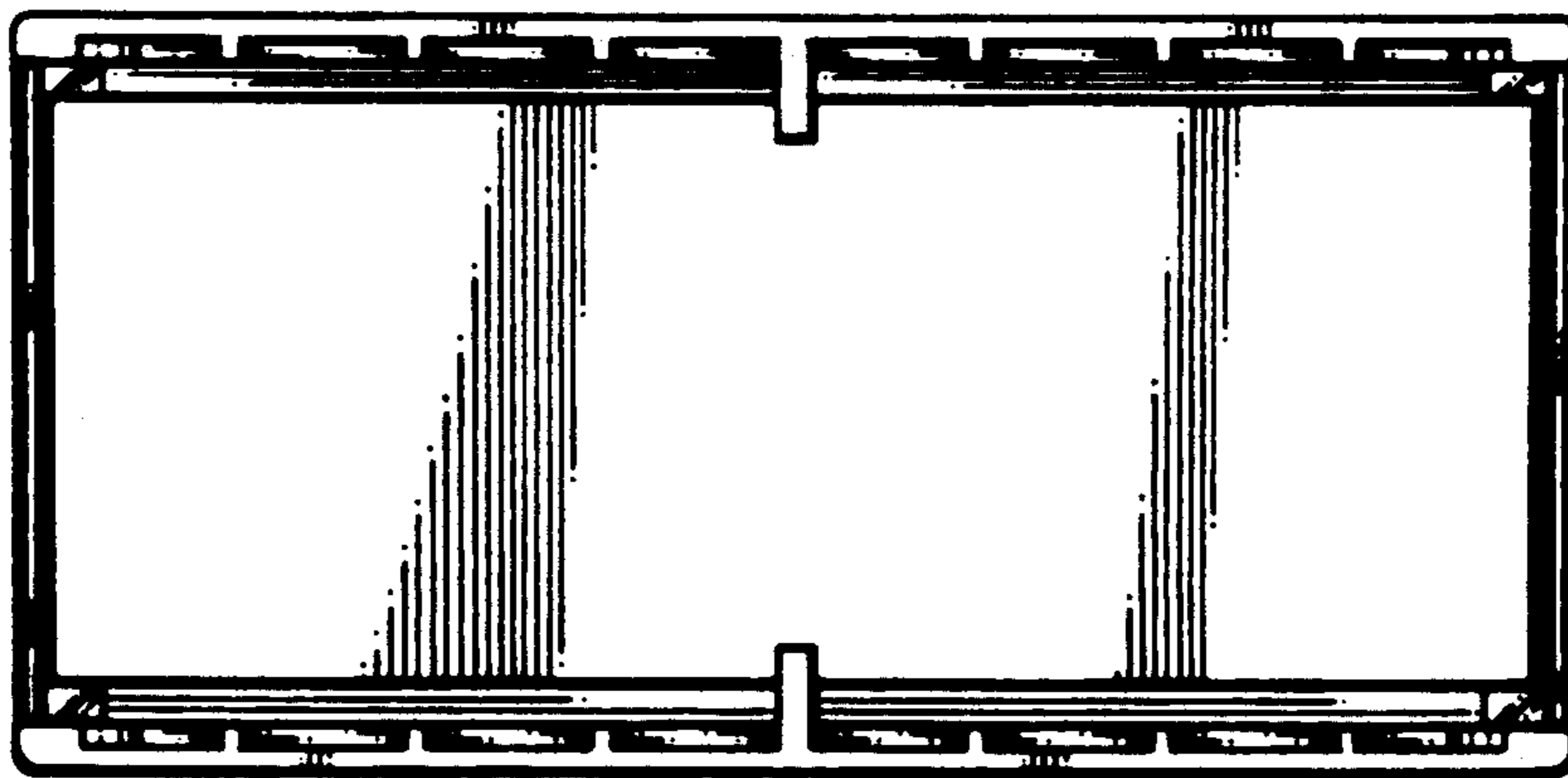

FIG. 7