



US00D343486S

United States Patent [19]

[11] Patent Number: **Des. 343,486**

Kimport

[45] Date of Patent: **** Jan. 18, 1994**

[54] **WASTE PAPER BURNER**

4,502,464 3/1985 Figueroa 110/251

[76] Inventor: **John E. Kimport**, R.D. 4 Box 386-A,
Jersey Shore, Pa. 17740

Primary Examiner—Kay H. Chin
Attorney, Agent, or Firm—Leon Gilden

[**] Term: **14 Years**

[57] **CLAIM**

[21] Appl. No.: **841,001**

The ornamental design for a waste paper burner, as shown and described.

[22] Filed: **Feb. 25, 1992**

DESCRIPTION

[52] U.S. Cl. **D34/1.1; D34/7**

[58] Field of Search 110/251, 242, 244;
220/908, 909; D34/1, 1.1, 7

FIG. 1 is a front elevational view of the waste paper burner showing my new design;

FIG. 2 is a rear elevational view thereof;

FIG. 3 is a left side elevational view thereof;

FIG. 4 is a right side elevational view thereof;

FIG. 5 is a top plan view thereof;

FIG. 6 is a bottom plan view thereof;

FIG. 7 is an exploded isometric view thereof; and,

FIG. 8 is a cross-sectional view thereof as viewed along line 8—8 in FIG. 5.

[56] **References Cited**

U.S. PATENT DOCUMENTS

D. 178,652	9/1956	Dunkelberger	D34/1.1
D. 333,025	2/1993	Doherty	D34/1
D. 333,893	3/1993	Washburn	D34/1.1
1,305,710	6/1919	Gribbs	110/251

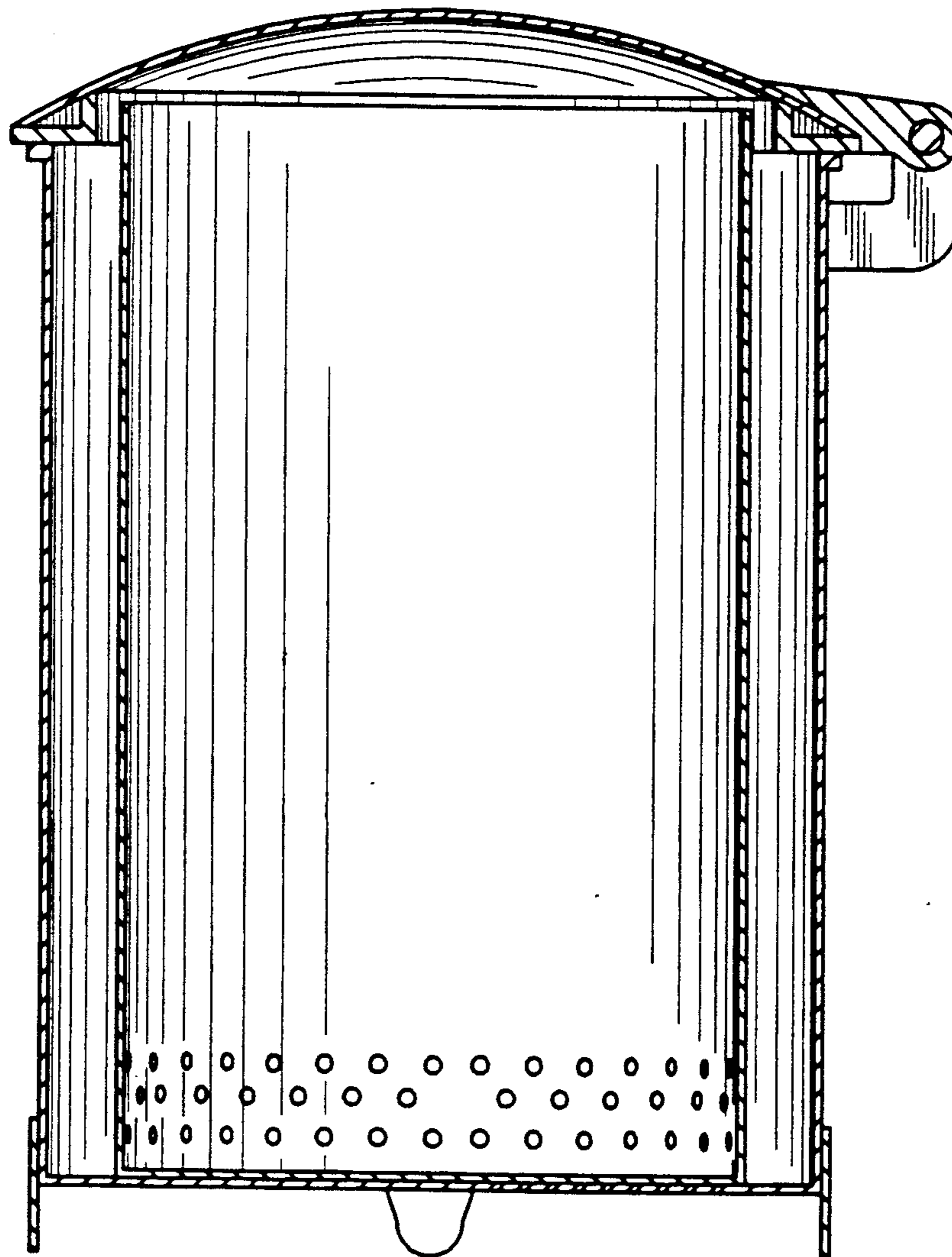

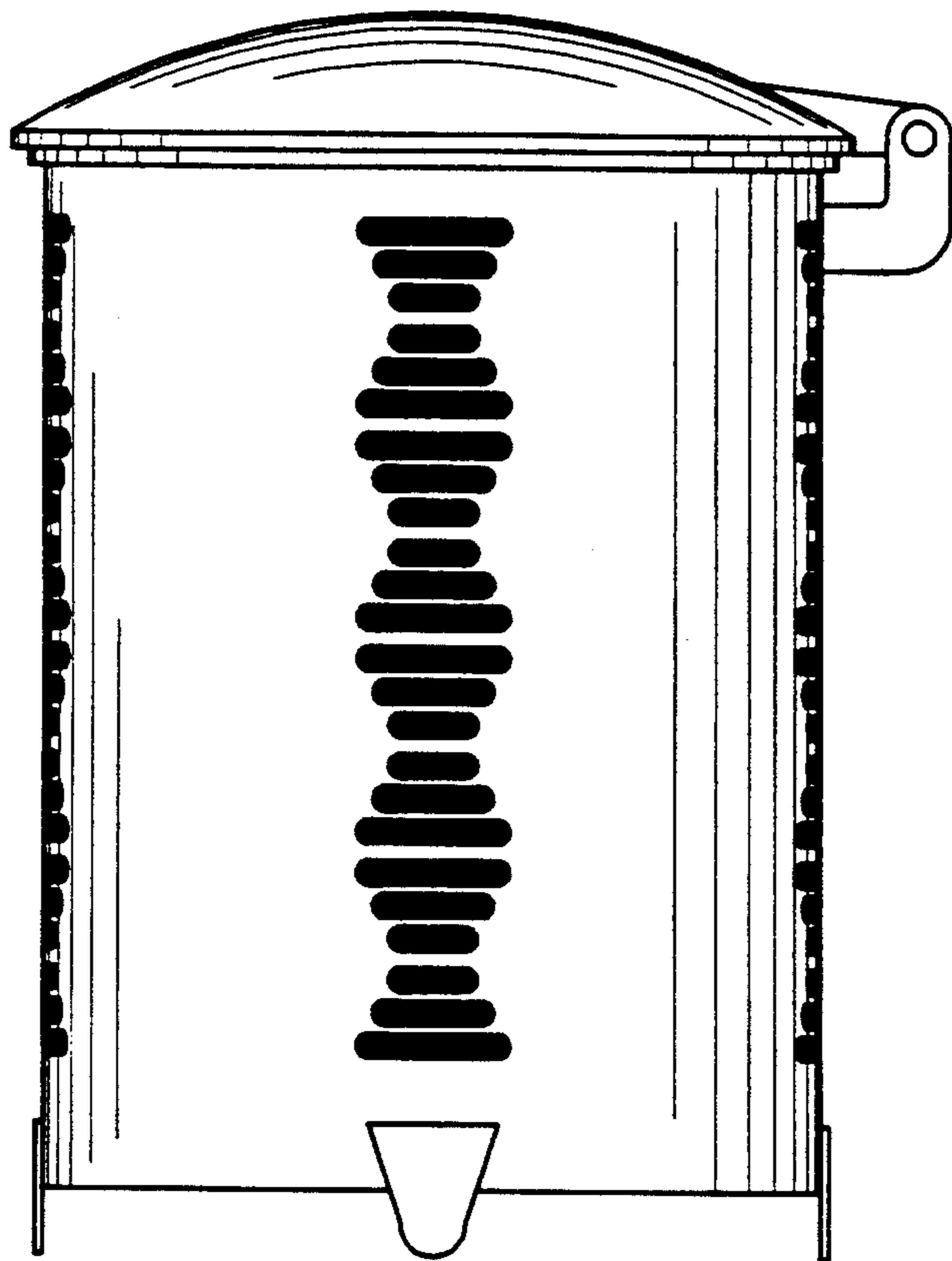

FIG. 1

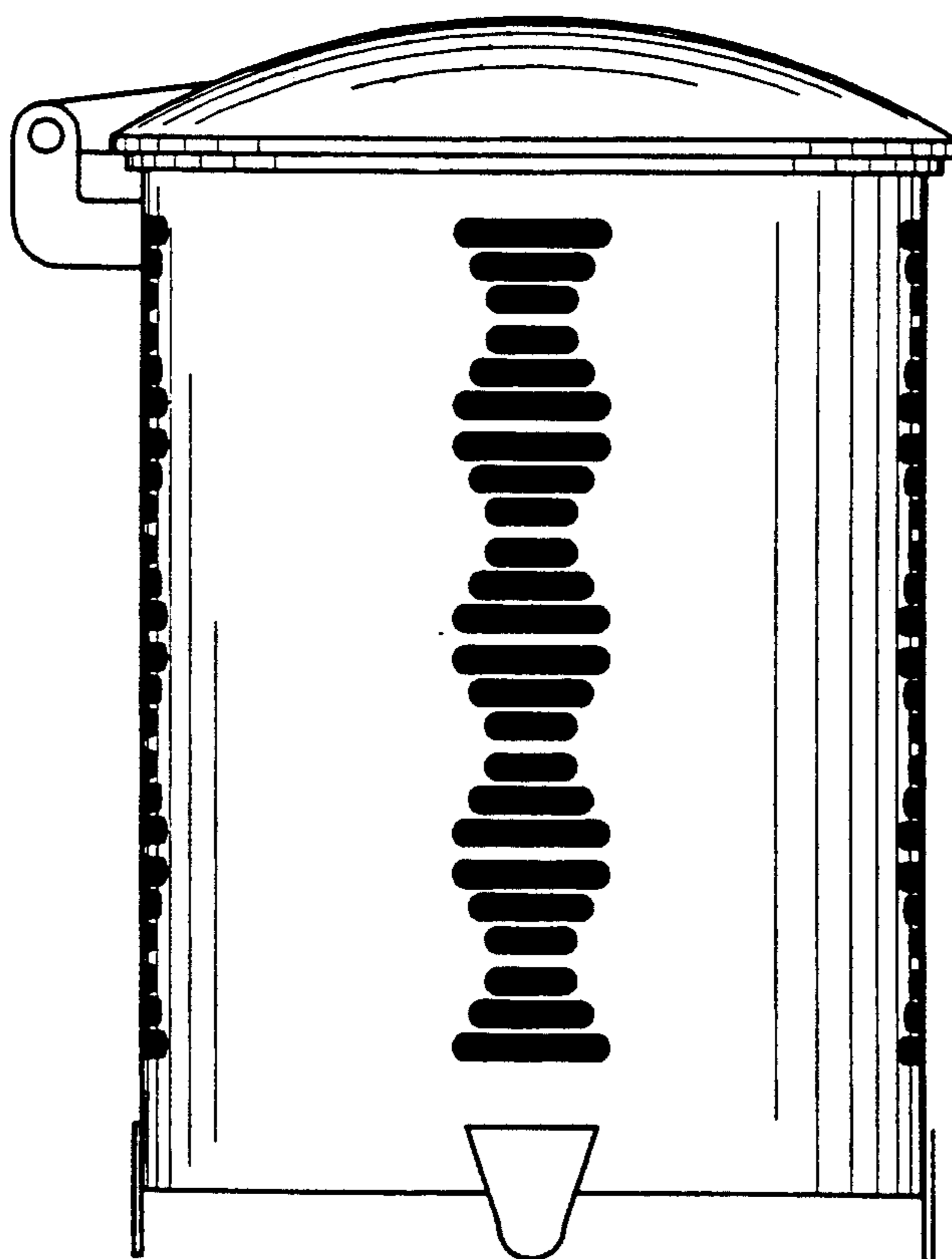

FIG. 2

FIG. 3

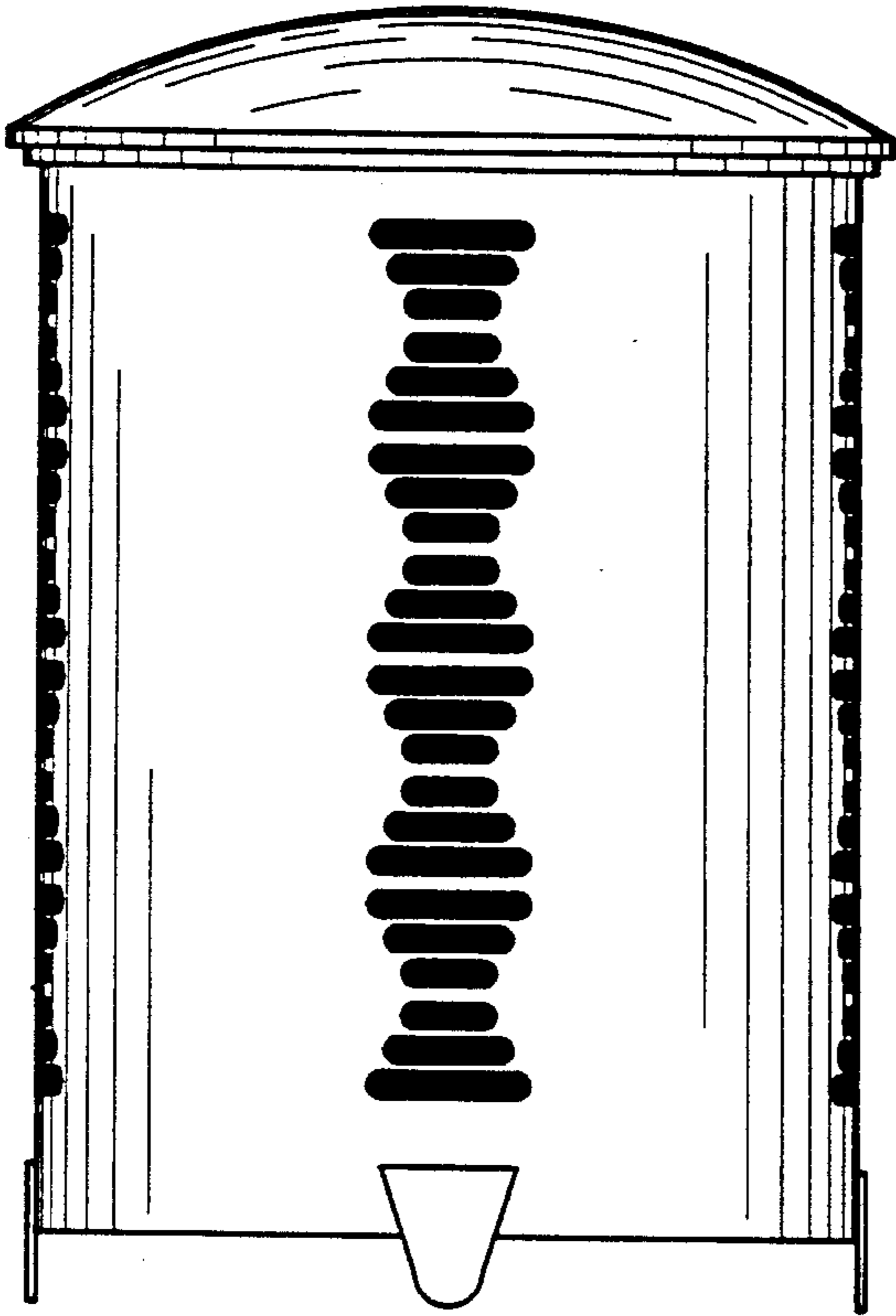

FIG. 4

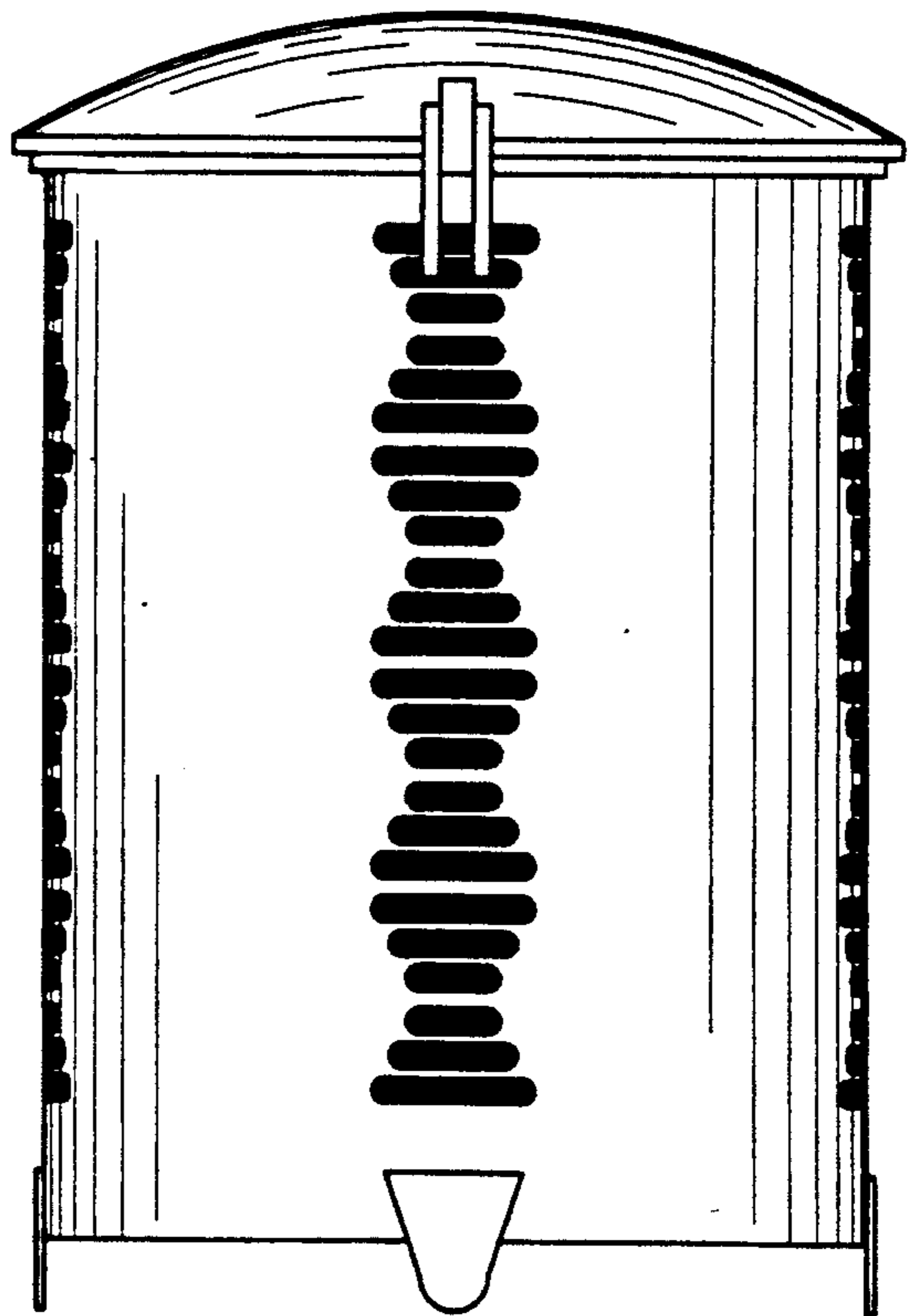

FIG. 5

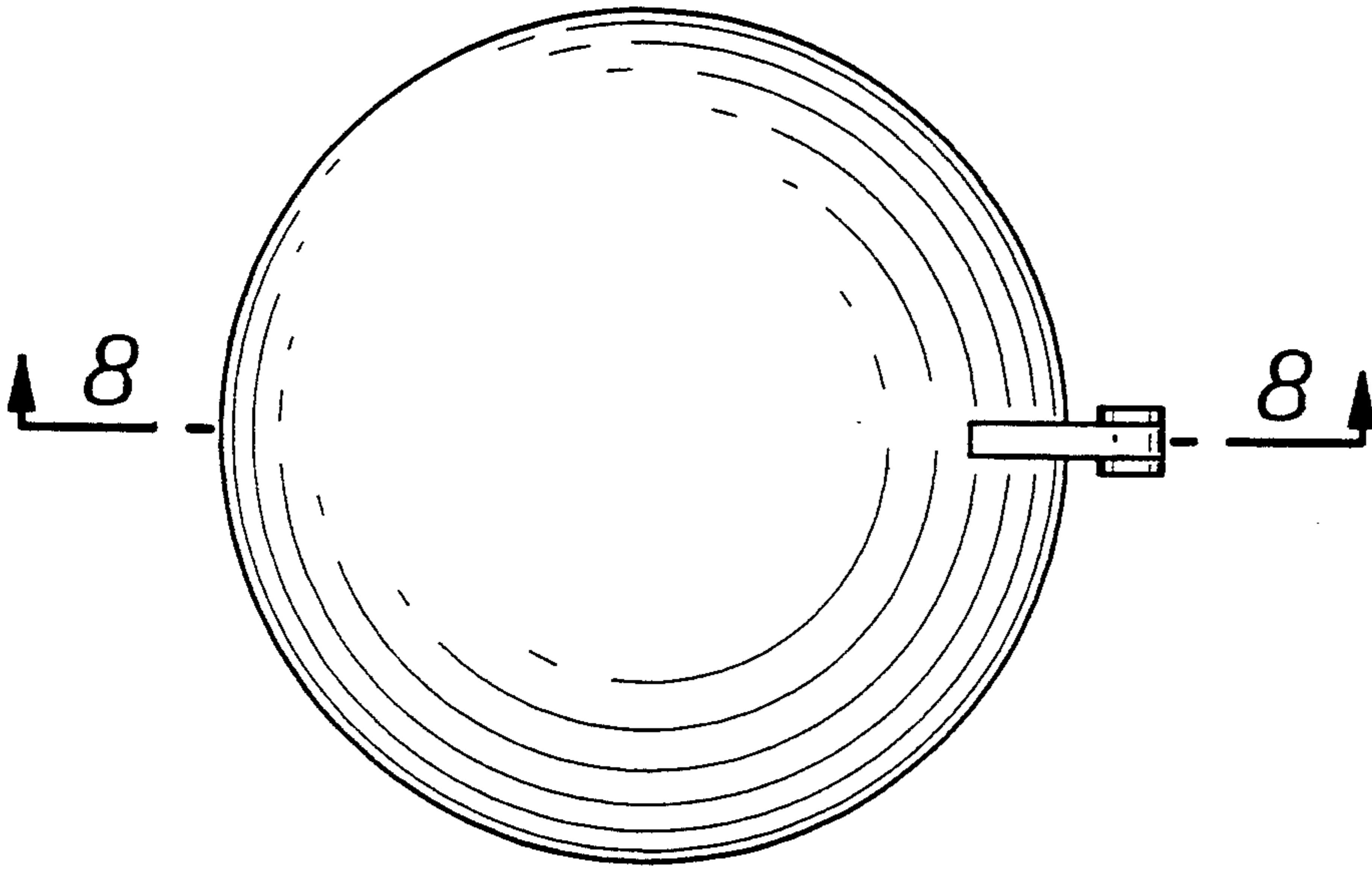

FIG. 6

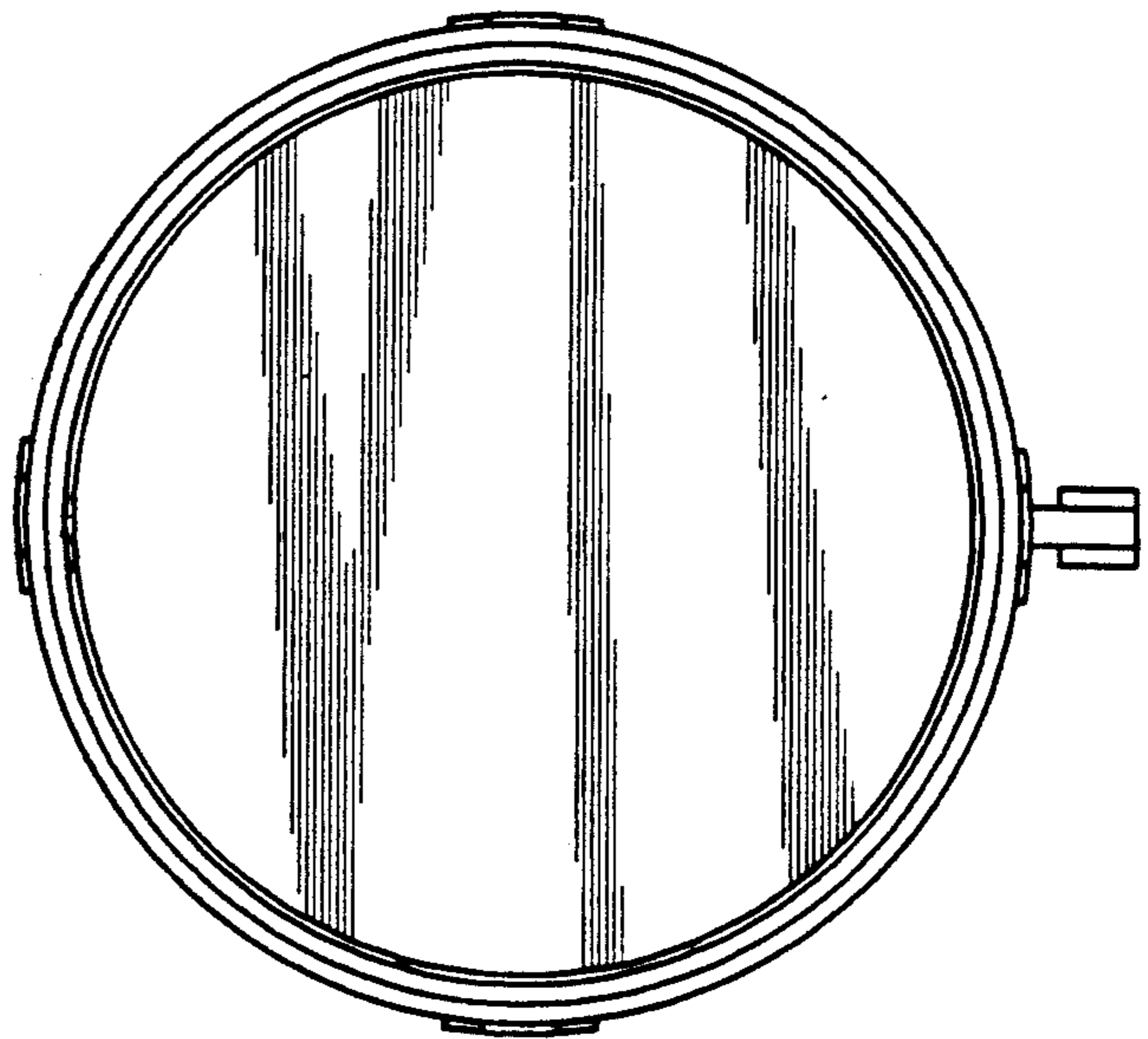

FIG. 7

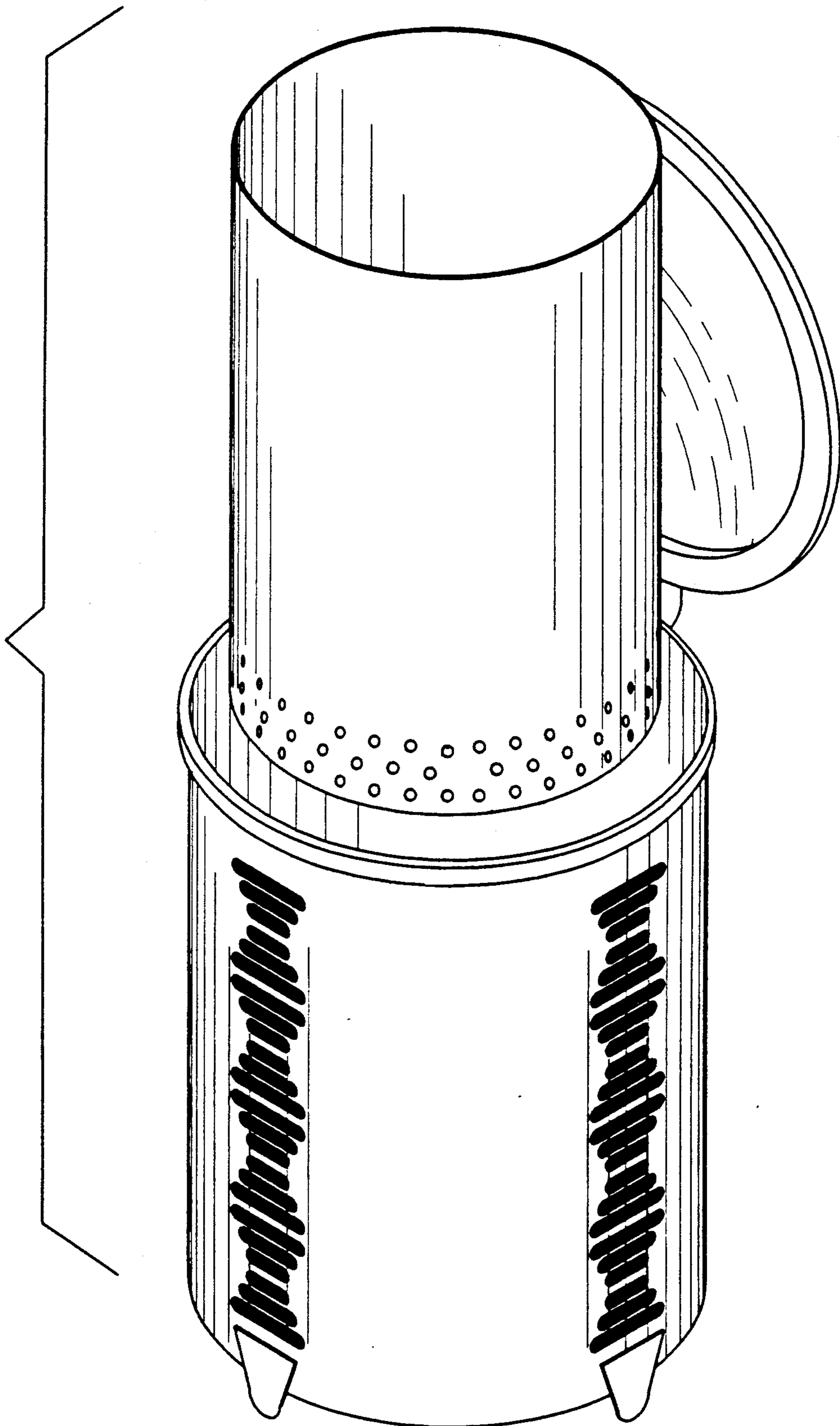

FIG. 8

