



US00D343403S

United States Patent [19]

[11] Patent Number: Des. 343,403

Takano et al.

[45] Date of Patent: ** Jan. 18, 1994

[54] VIDEO CAMERA WITH VIDEO TAPE RECORDER

[75] Inventors: Hiroshi Takano; Atsushi Sawada, both of Ehime, Japan

[73] Assignee: Matsushita Electric Industrial Co., Ltd., Osaka, Japan

[**] Term: 14 Years

[21] Appl. No.: 900,104

[22] Filed: Jun. 16, 1992

[30] Foreign Application Priority Data

Dec. 26, 1991 [JP]	Japan	3-39626
[52] U.S. Cl.		D16/202
[58] Field of Search		352/34, 242, 243; 354/82, 288; 358/229, 906; D16/200-205, 208

[56] References Cited

U.S. PATENT DOCUMENTS

D. 334,395	3/1993	Kurokawa	D16/202
D. 334,396	3/1993	Mori et al.	D16/202
D. 335,500	5/1993	Mori et al.	D16/202
5,189,520	2/1993	Okayasu et al.	358/229

OTHER PUBLICATIONS

Popular Photography, Mar. 1989, p. 51 (Yashica KD-5010).

Ritz Camera Catalog, Aug. 1991 p. 24 (Panasonic PV-21, item D).

Primary Examiner—Bernard Ansher
Assistant Examiner—Adir Aronovich
Attorney, Agent, or Firm—Sughrue, Mion, Zinn, Macpeak & Seas

[57] CLAIM

The ornamental design for a video camera with video tape recorder, as shown and described.

DESCRIPTION

FIG. 1 is a front, top and right side perspective view of a video camera with video tape recorder showing our new design;

FIG. 2 is a front elevational view thereof;

FIG. 3 is a rear elevational view thereof;

FIG. 4 is a right side elevational view thereof;

FIG. 5 is a left side elevational view thereof;

FIG. 6 is a top plan view thereof;

FIG. 7 is a bottom plan view thereof;

FIG. 8 is a rear, top and left side perspective view thereof; and,

FIG. 9 is a rear, top and left side perspective view thereof with the eyepiece rotated 90° to a vertically upright position.

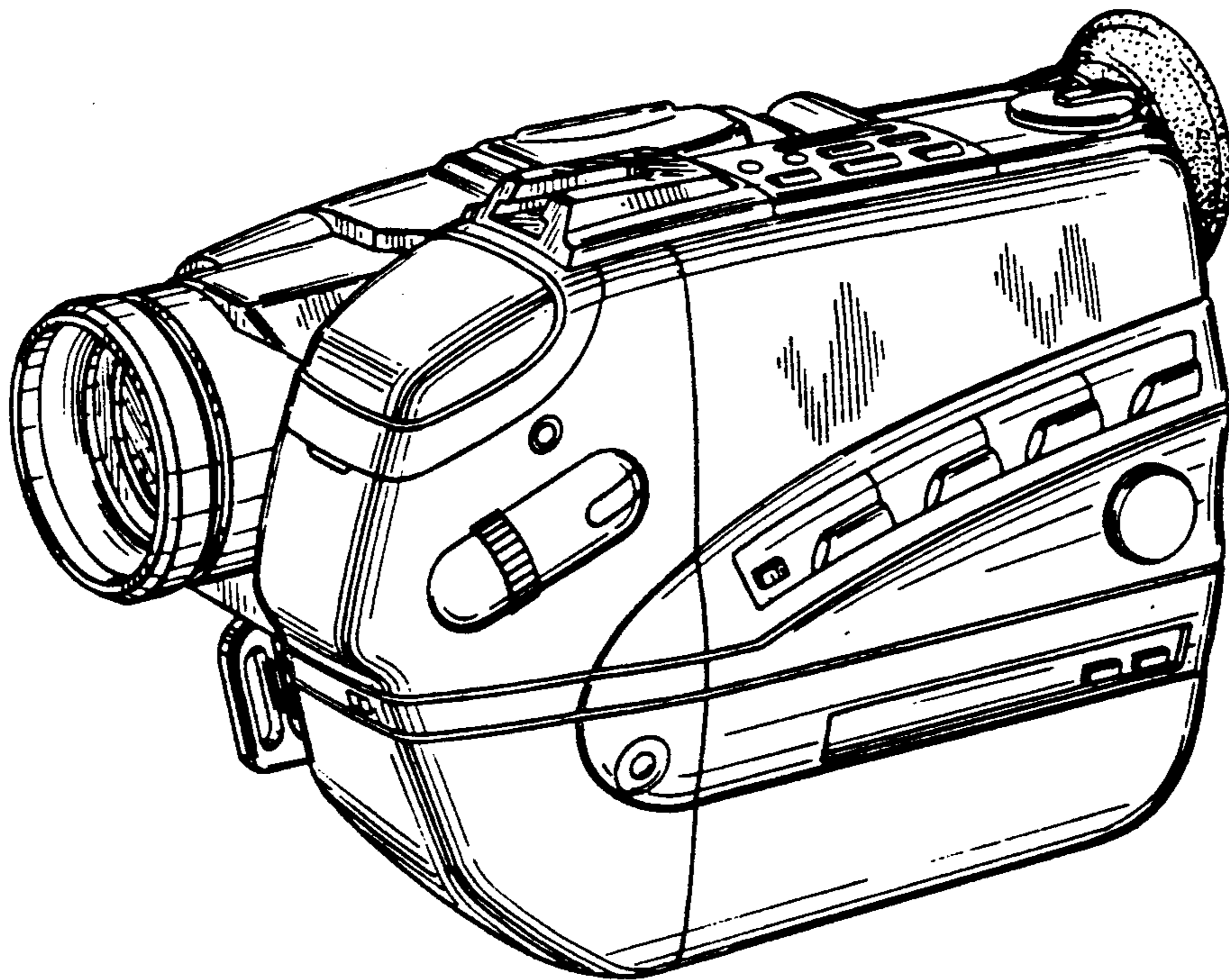

FIG. 1

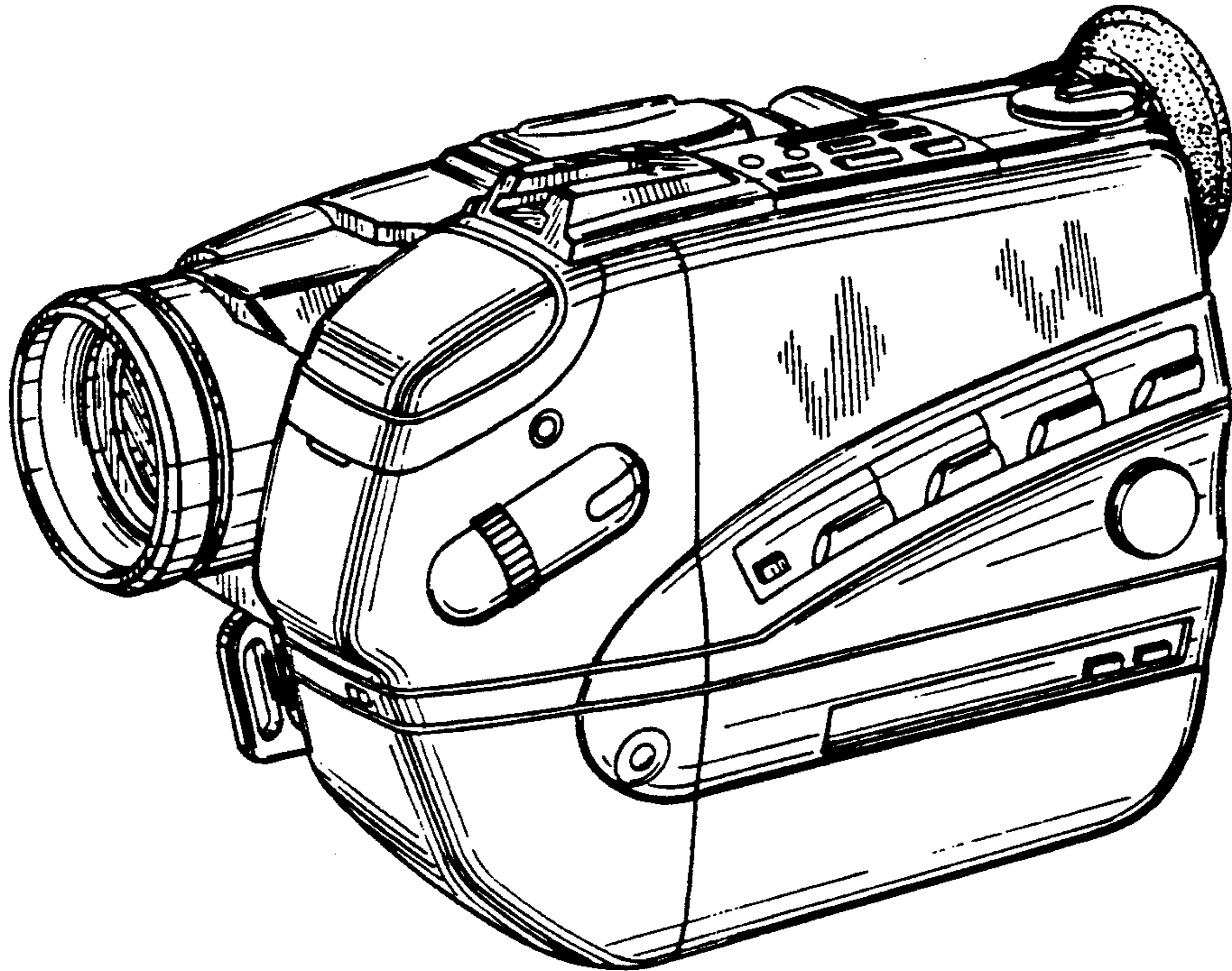

FIG. 2

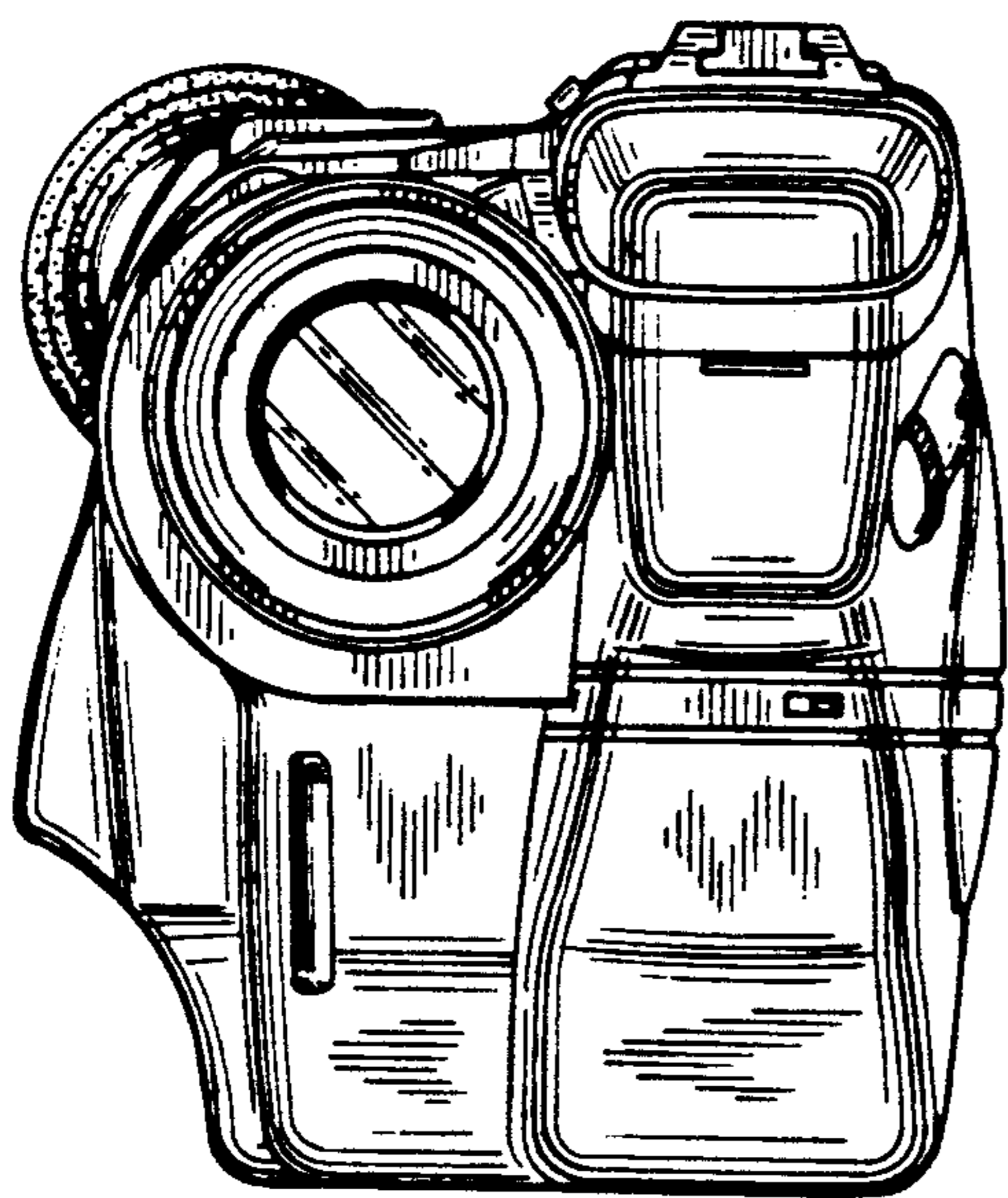

FIG. 3

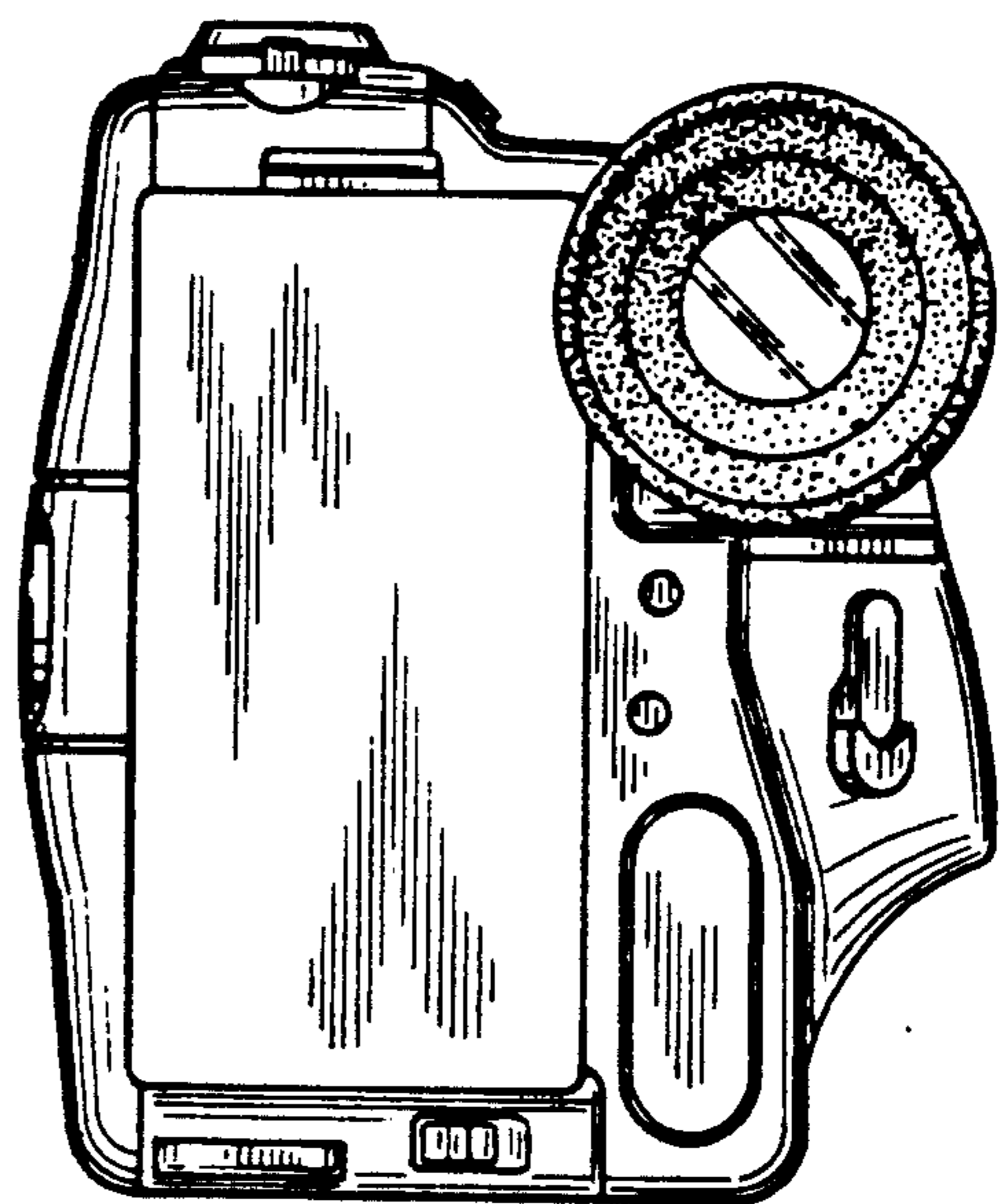

FIG. 4

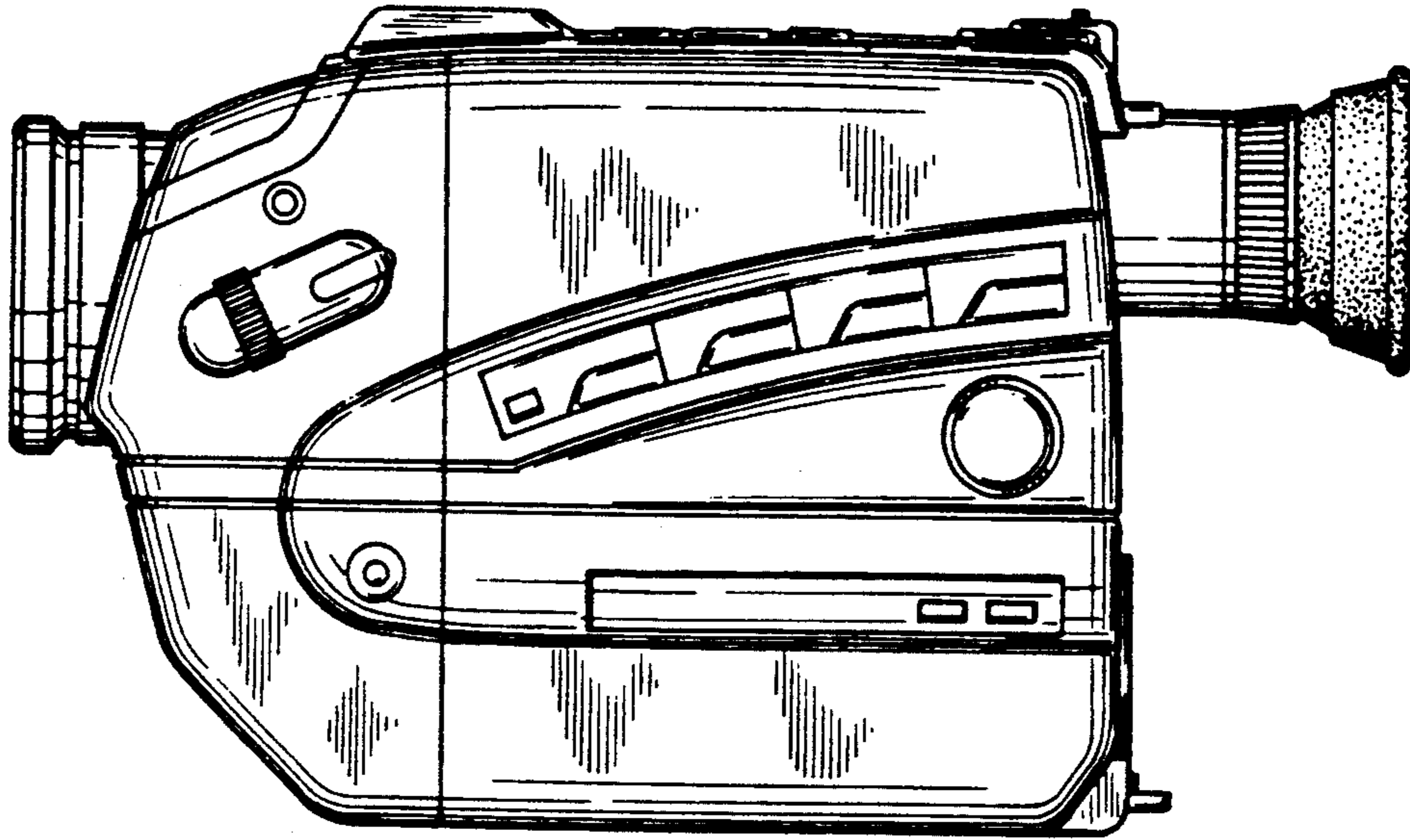

FIG. 5

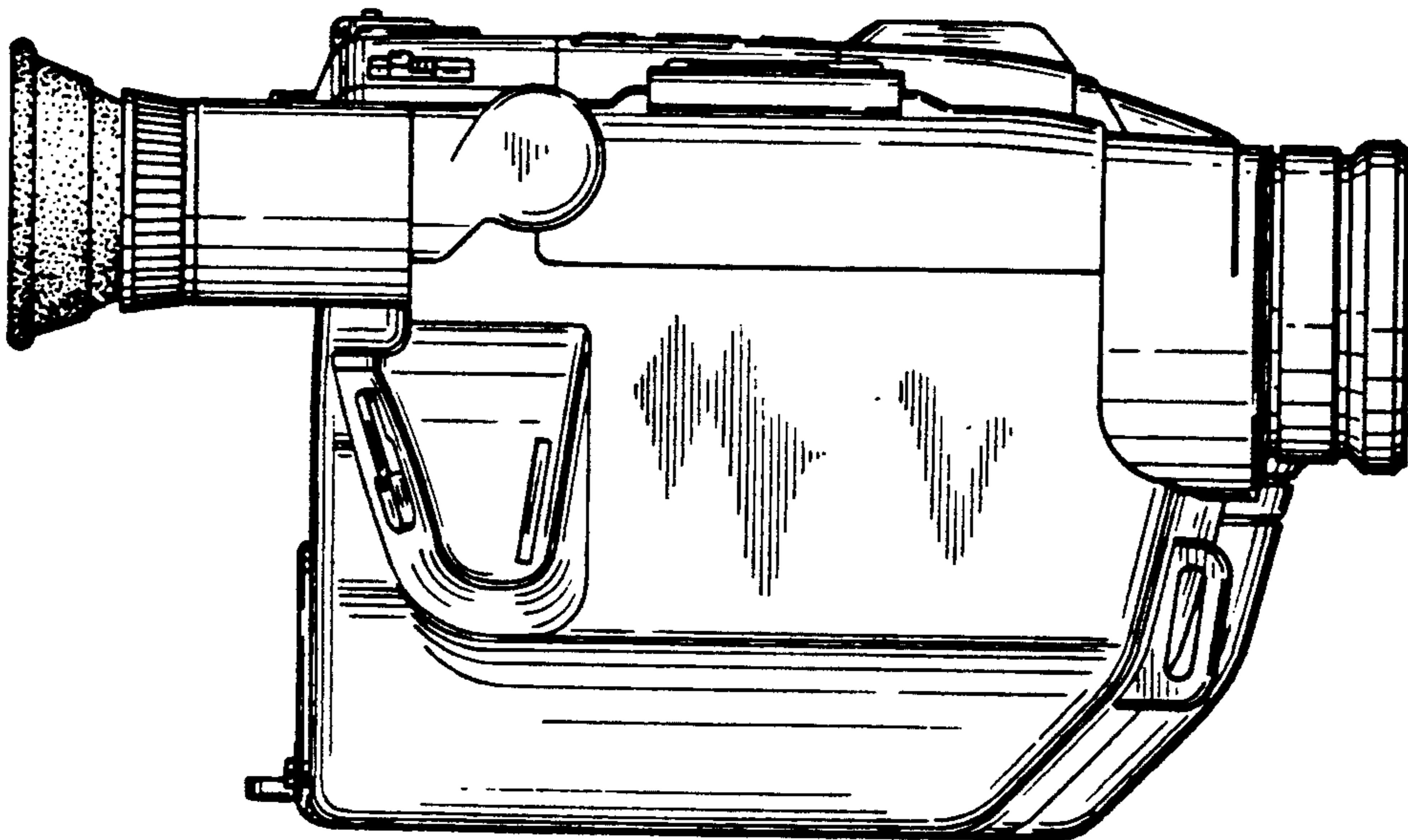

FIG. 6

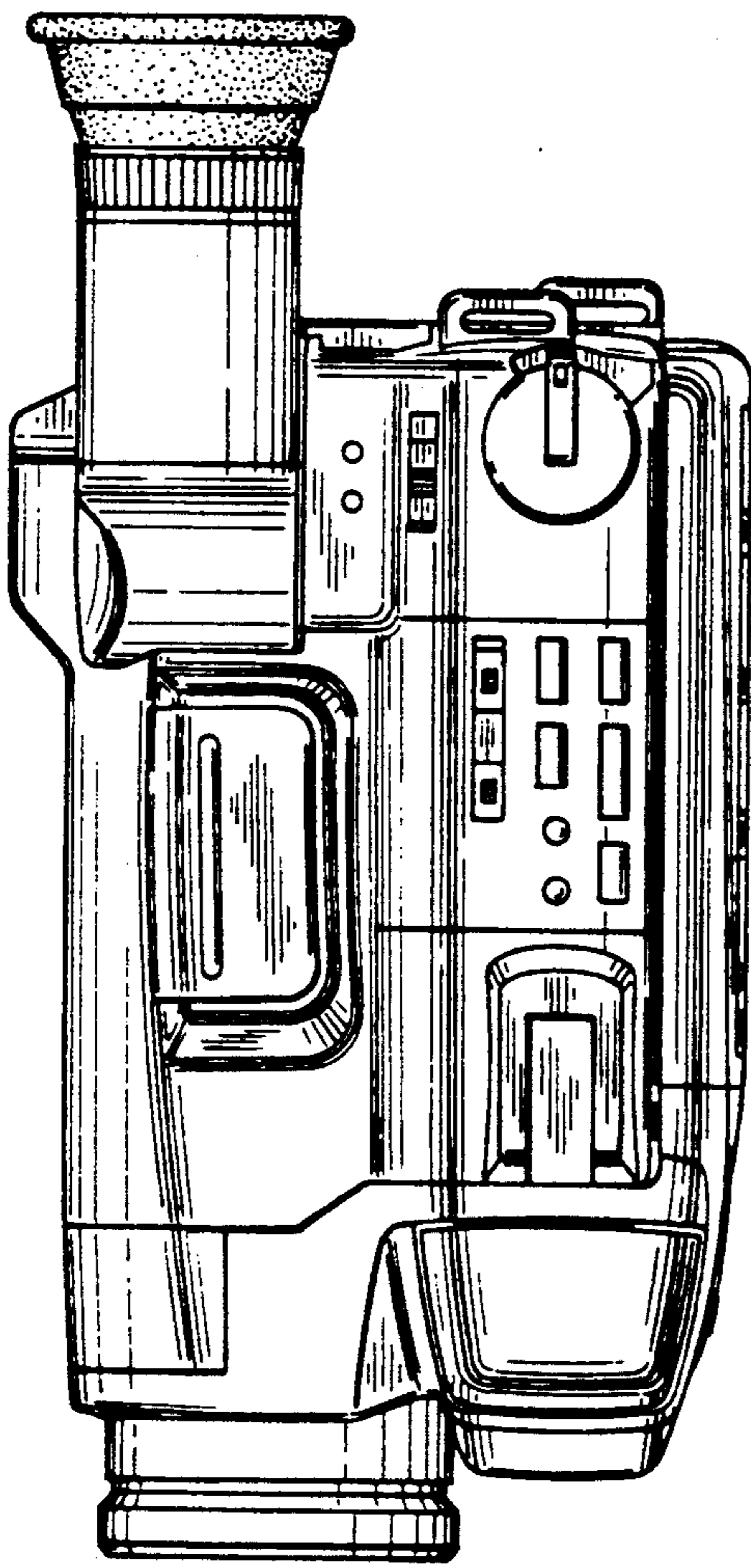

FIG. 7

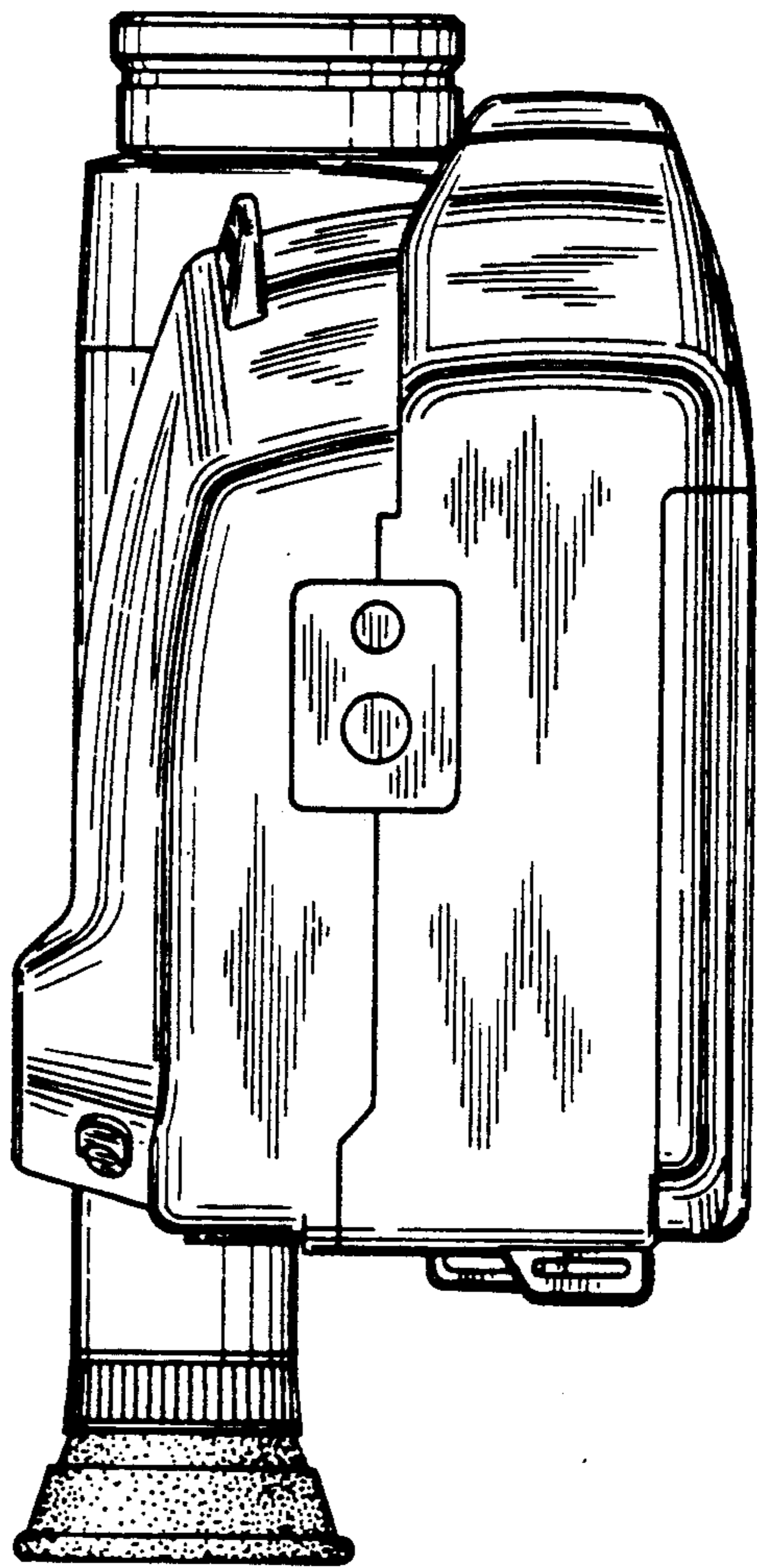

FIG. 8

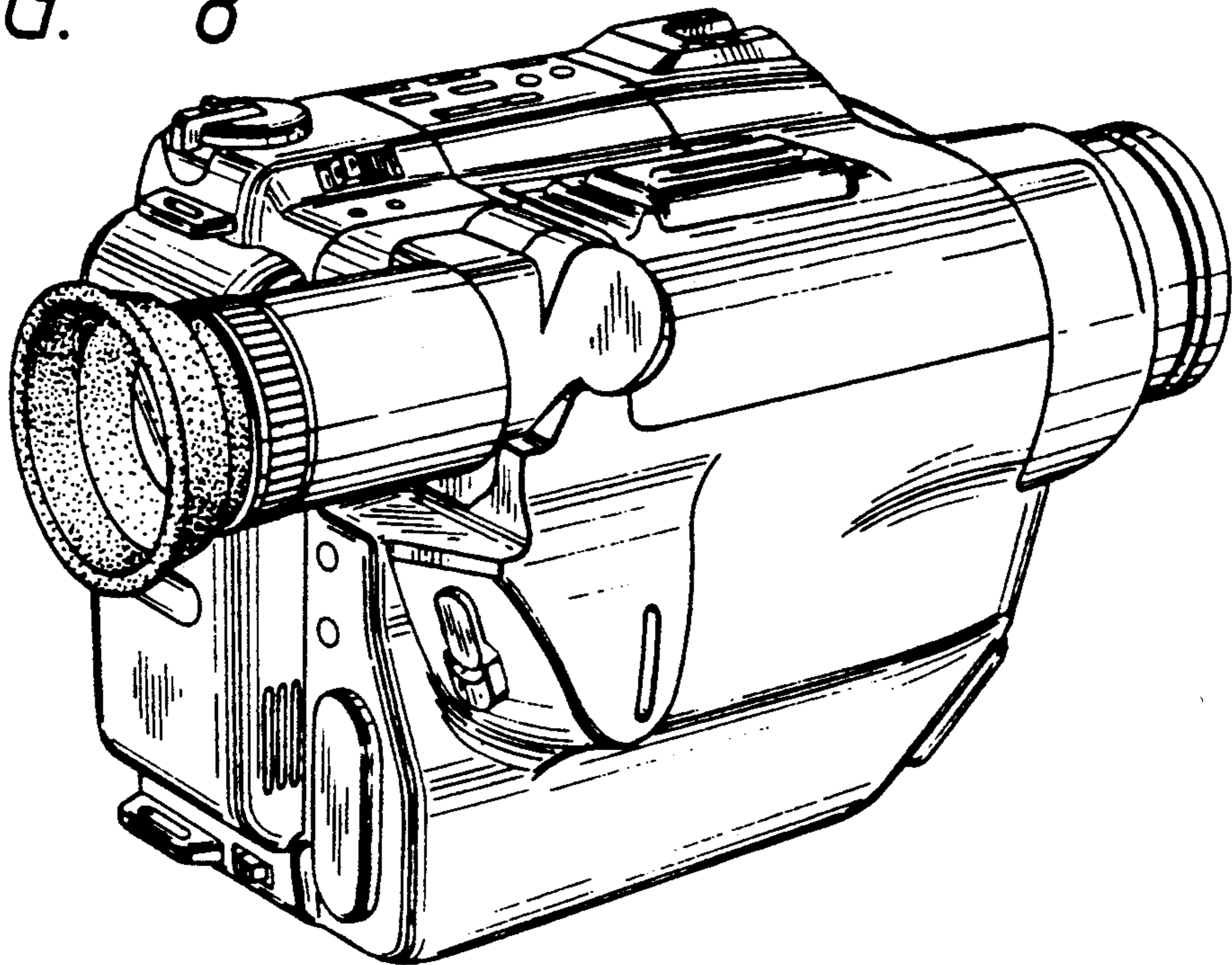

FIG. 9

