



US00D343385S

United States Patent [19]

[11] Patent Number: **Des. 343,385**

Sachs

[45] Date of Patent: **** Jan. 18, 1994**

[54] **ELECTRICAL GROUND CLIP**

4,186,981 2/1980 Holton 439/92

[76] Inventor: **Isaac Sachs**, 283 Newton,
Dollard-des-Ormeaux, Quebec,
Canada, H9A 3G1

Primary Examiner—Wallace R. Burke
Assistant Examiner—Joel Sincavage
Attorney, Agent, or Firm—Longacre & White

[*] Notice: The portion of the term of this patent
subsequent to Oct. 12, 2007 has been
disclaimed.

[57] **CLAIM**

The ornamental design for an electrical ground clip, as
shown and described.

[**] Term: **14 Years**

DESCRIPTION

[21] Appl. No.: **924,870**

[22] Filed: **Aug. 5, 1992**

Related U.S. Application Data

[63] Continuation-in-part of Ser. No. 837,427, Feb. 20, 1992.

[52] U.S. Cl. **D13/154**

[58] Field of Search D8/356; 174/6, 35 GC,
174/40 CC, 51; 439/92, 95, 108, 110; D13/133,
154

FIG. 1 is a right side, top and front perspective view of
an electrical ground clip showing my new design;
FIG. 2 is a front elevational view thereof;
FIG. 3 is a left side elevational view thereof;
FIG. 4 is a right side elevational view thereof;
FIG. 5 is a rear elevational view thereof;
FIG. 6 is a top plan view thereof;
FIG. 7 is a bottom plan view thereof;
FIG. 8 is a left side, top and front perspective view of an
electrical ground clip showing a second embodiment of
my new design;
FIG. 9 is a front elevational view thereof;
FIG. 10 is a left side elevational view thereof;
FIG. 11 is a right side elevational view thereof;
FIG. 12 is a rear elevational view thereof;
FIG. 13 is a top plan view thereof; and,
FIG. 14 is a bottom plan view thereof.

[56] References Cited

U.S. PATENT DOCUMENTS

D. 297,410	8/1988	Sachs	D8/356
2,911,608	11/1959	Lee	174/35 GC
3,029,405	4/1962	Buchanan	439/95
3,919,457	11/1975	Steiner	439/110 X

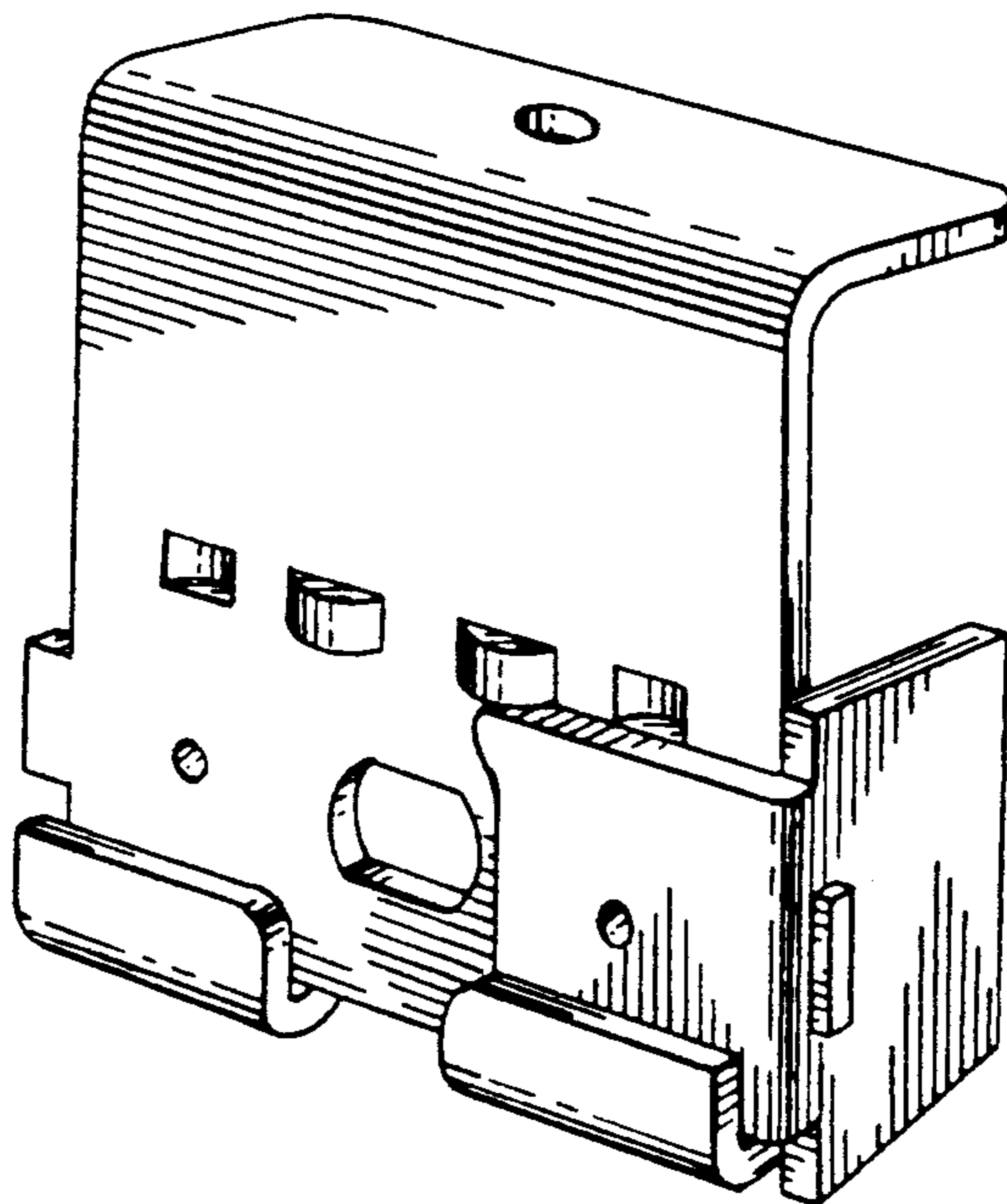

Fig. 1

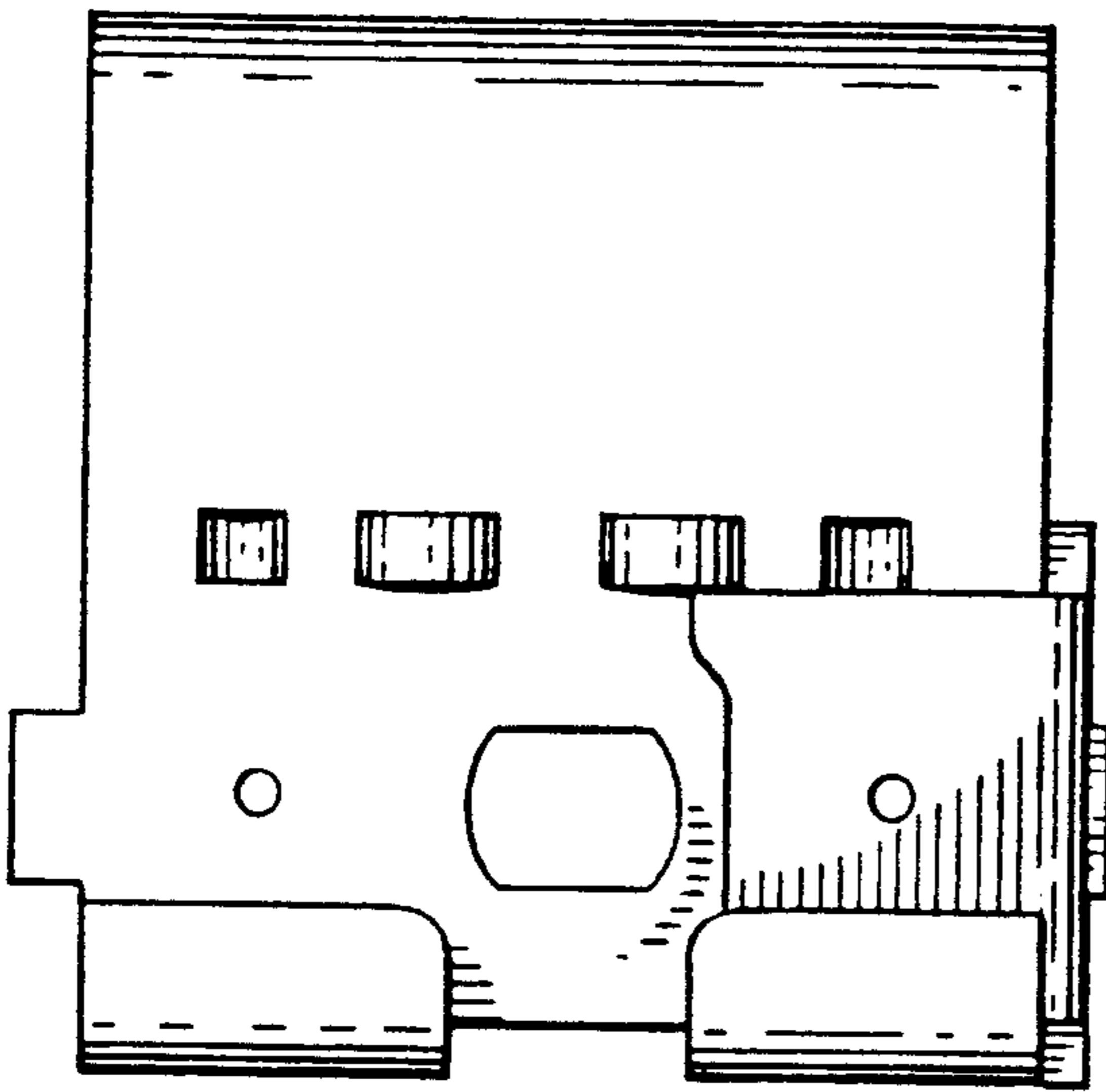
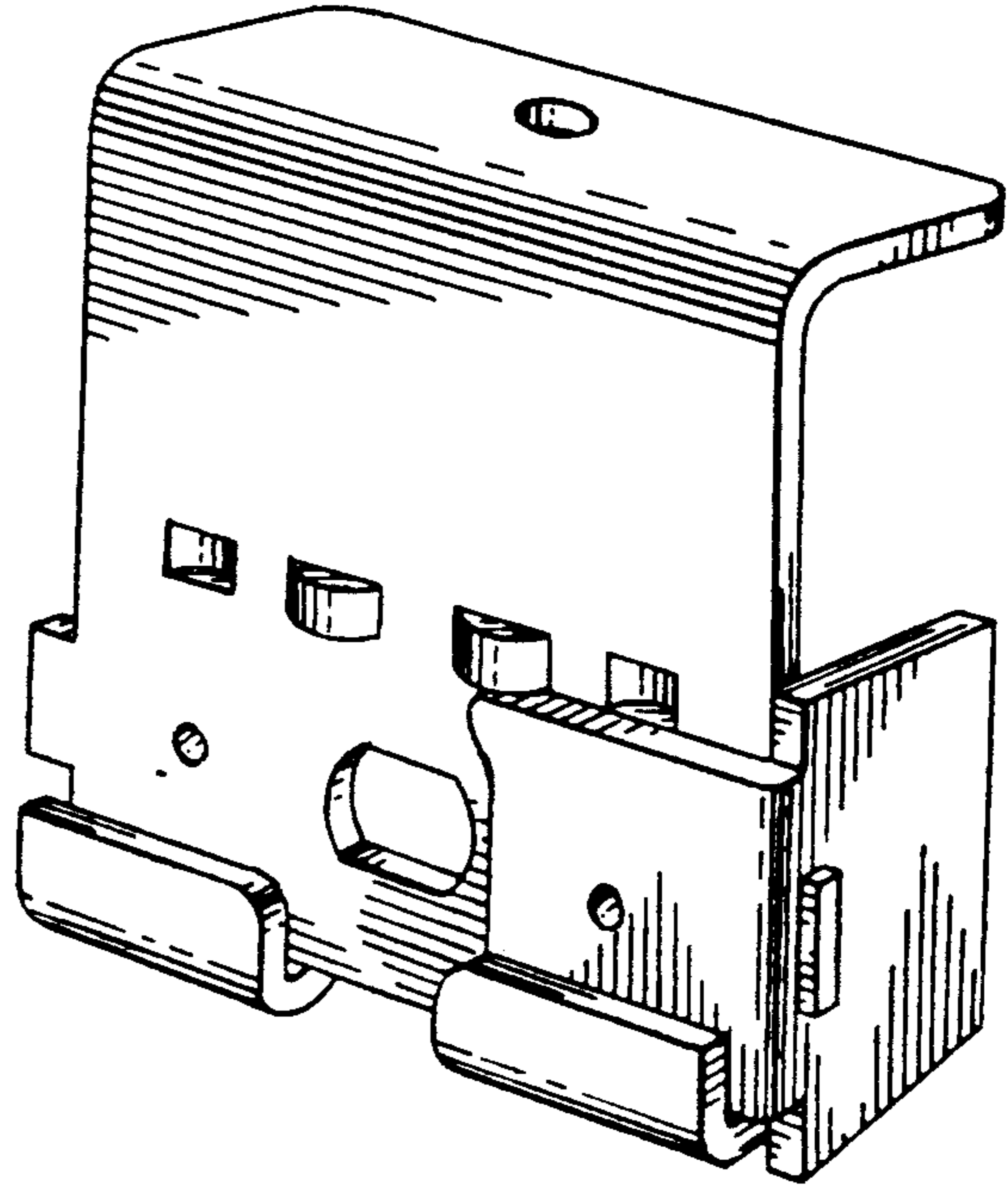
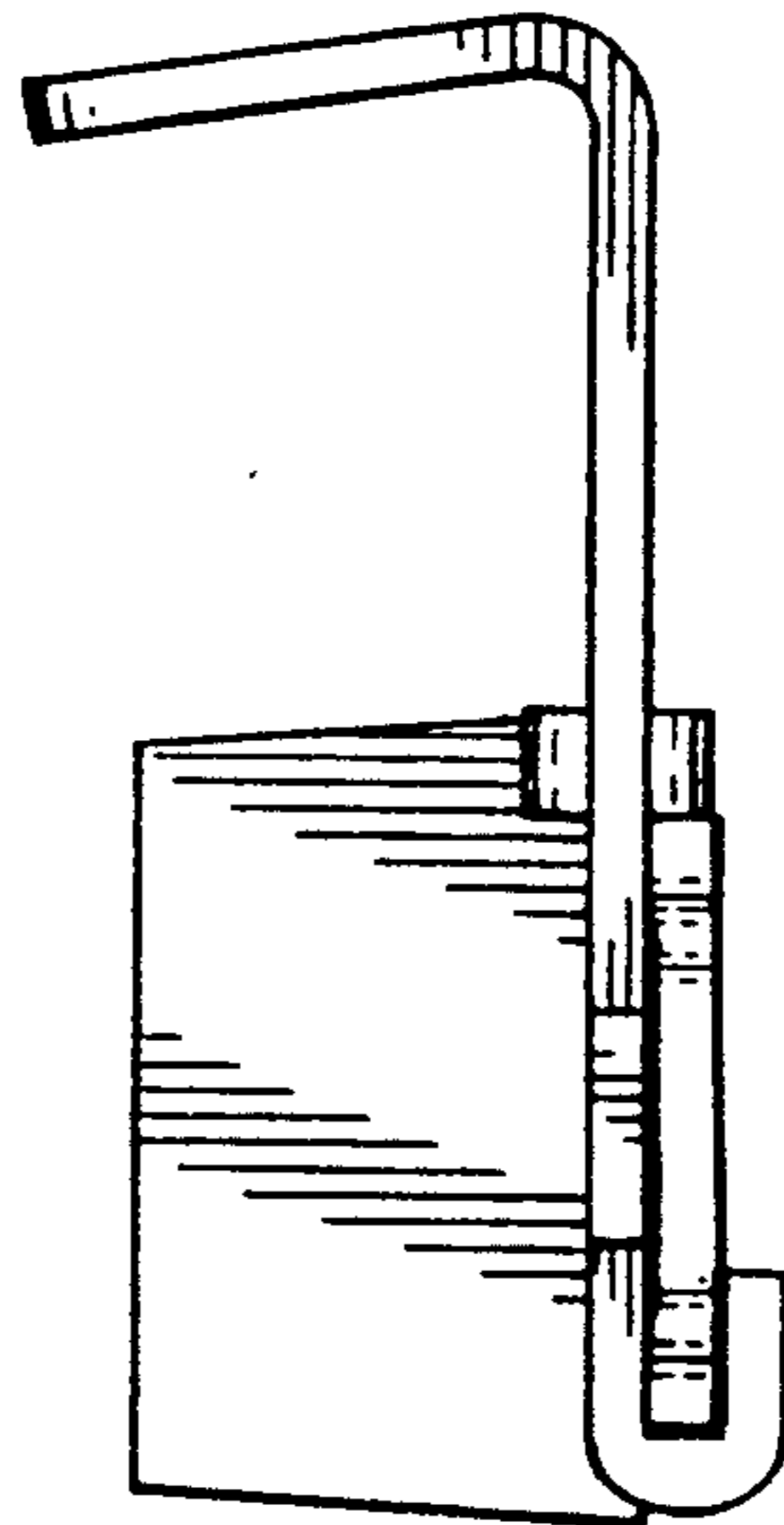

Fig. 2

Fig. 3



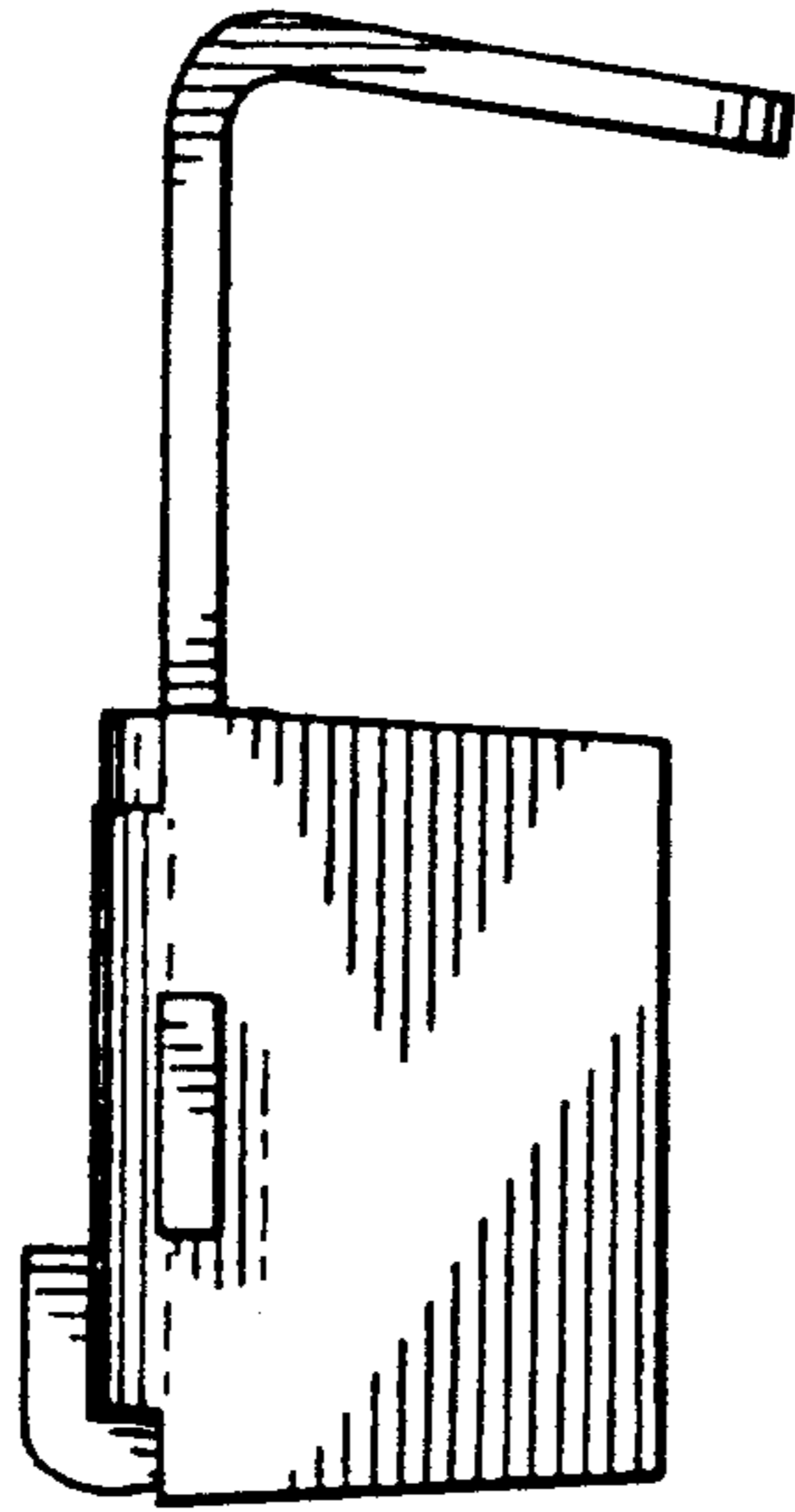

Fig. 4

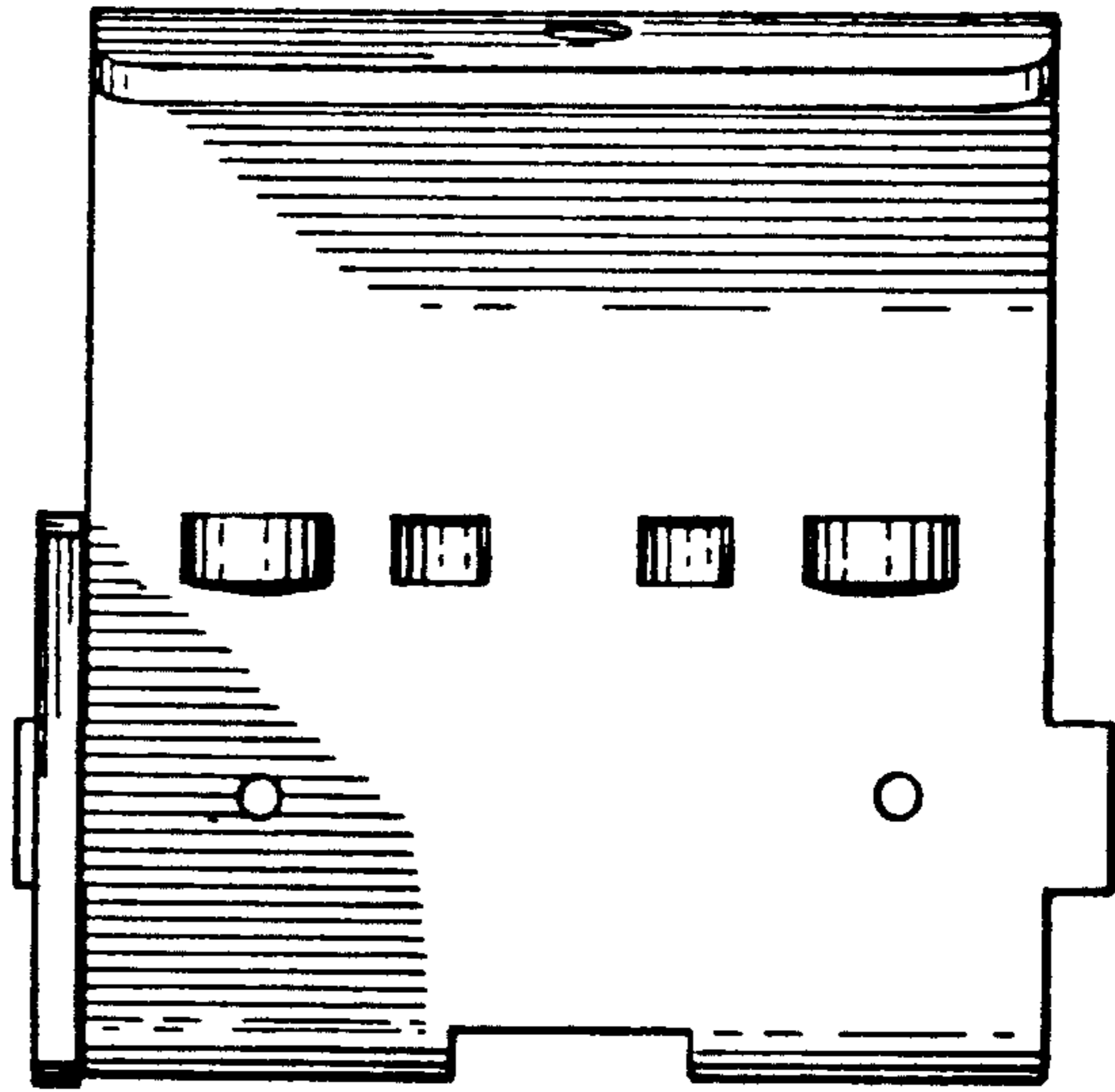

Fig. 5

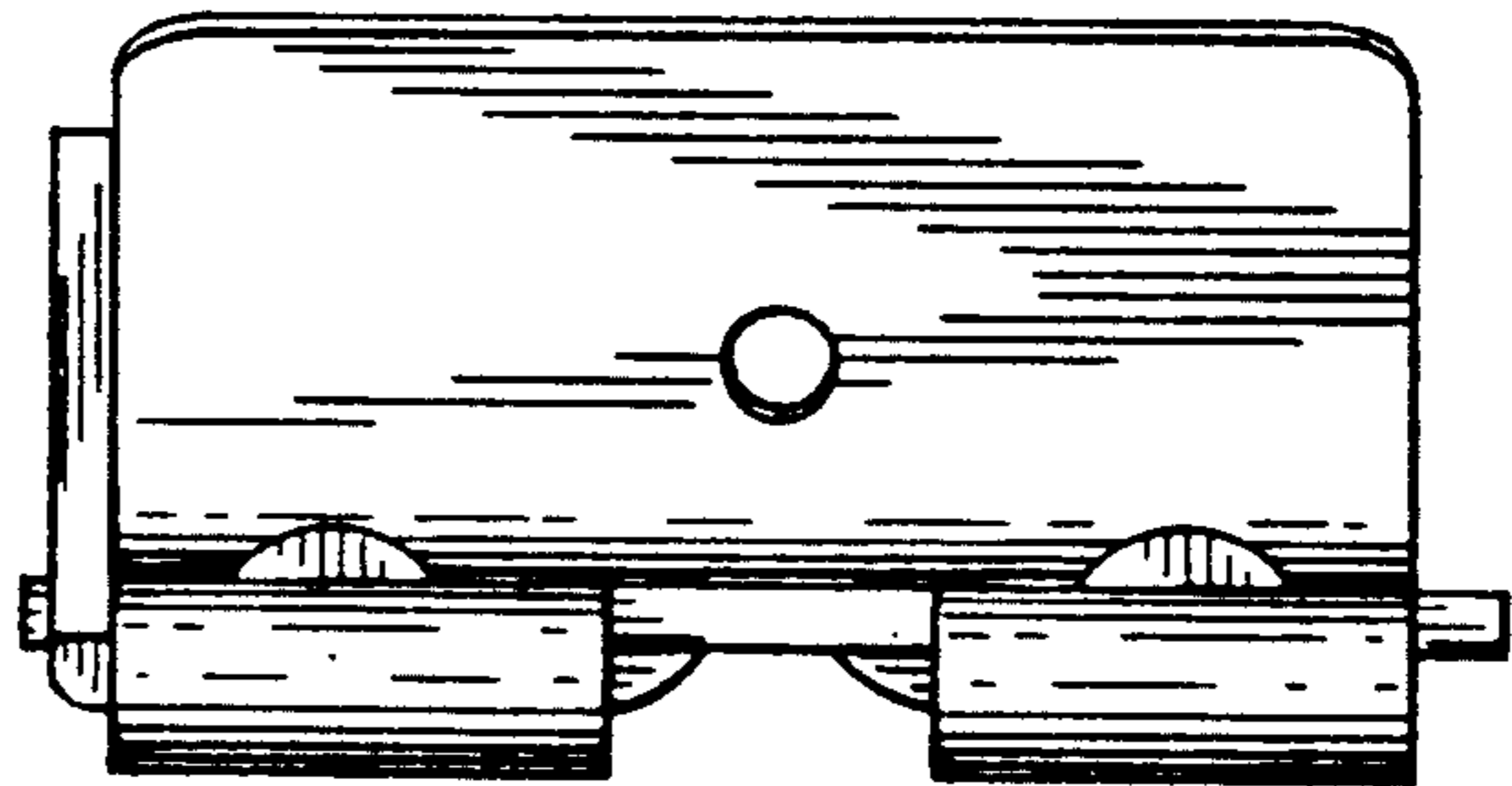
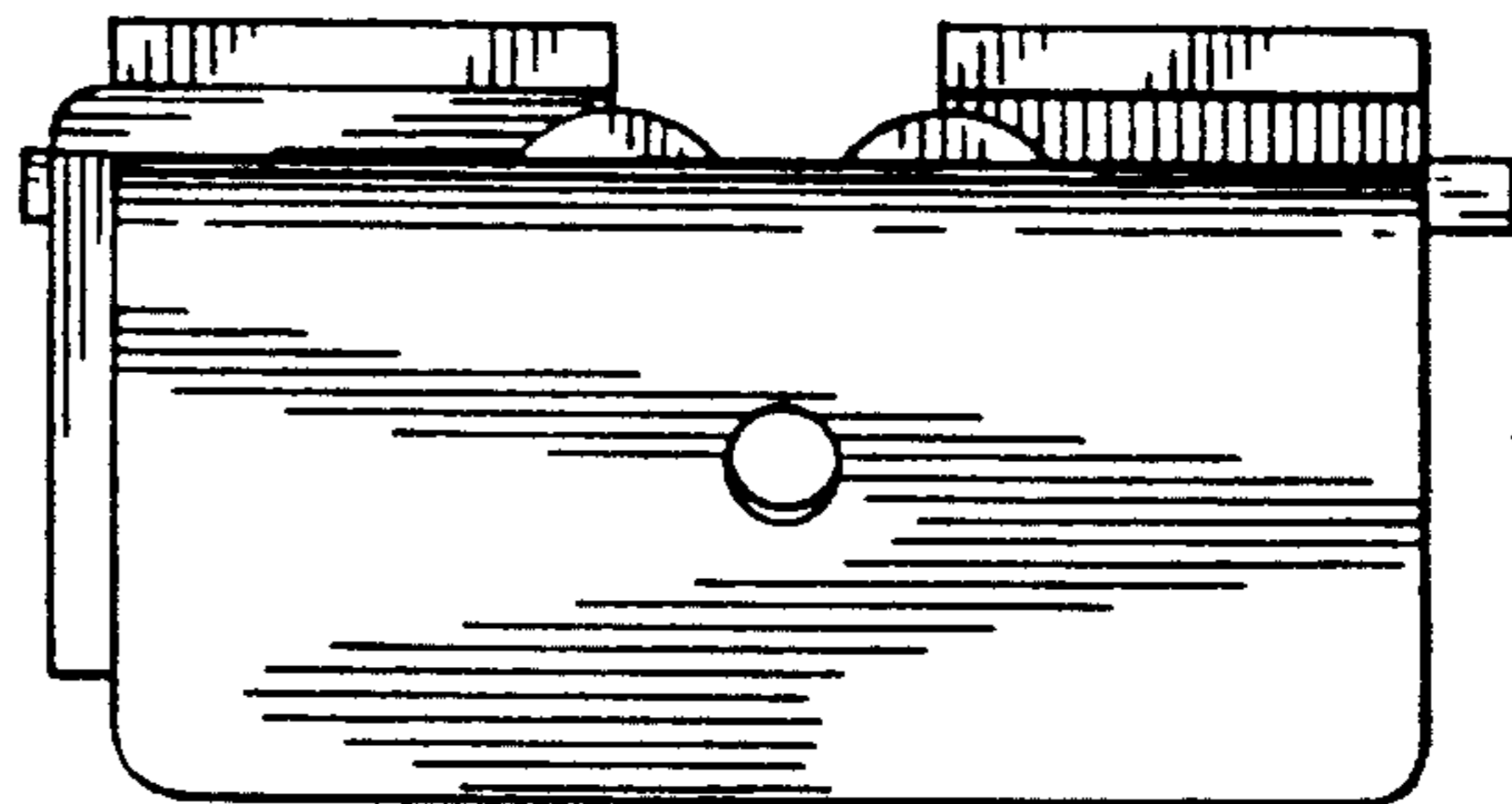

Fig. 7

Fig. 6



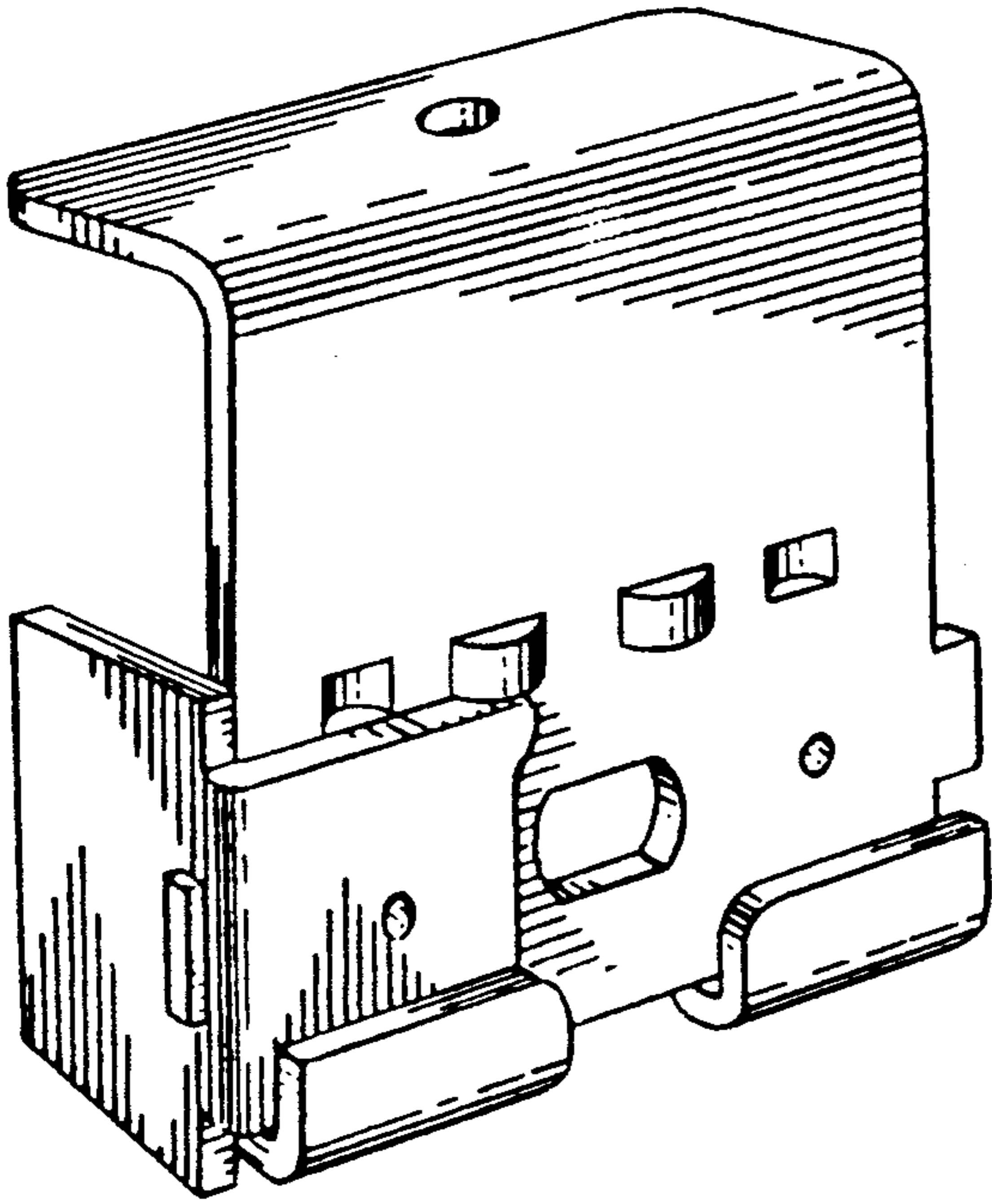

Fig. 8

Fig. 9

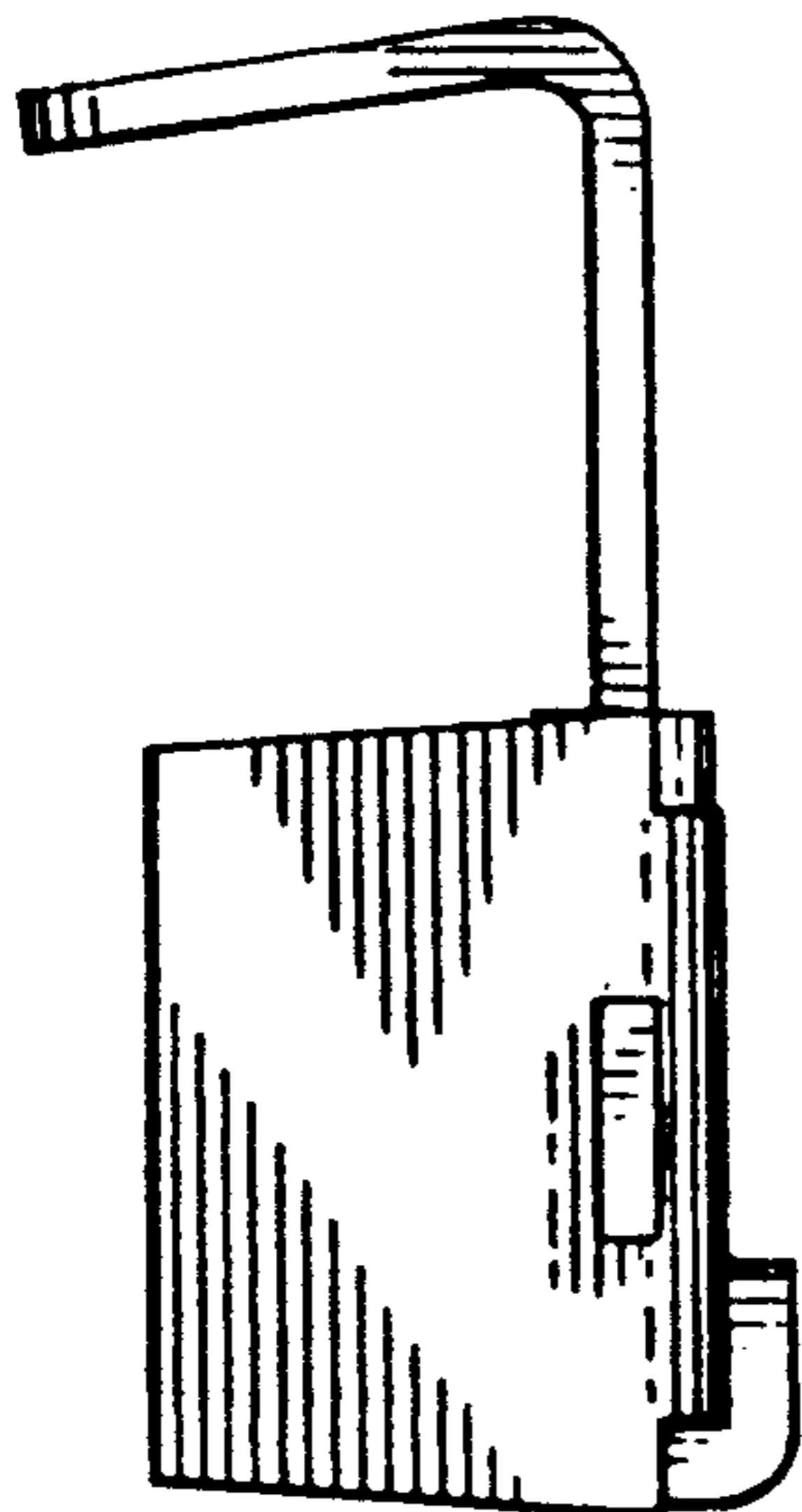
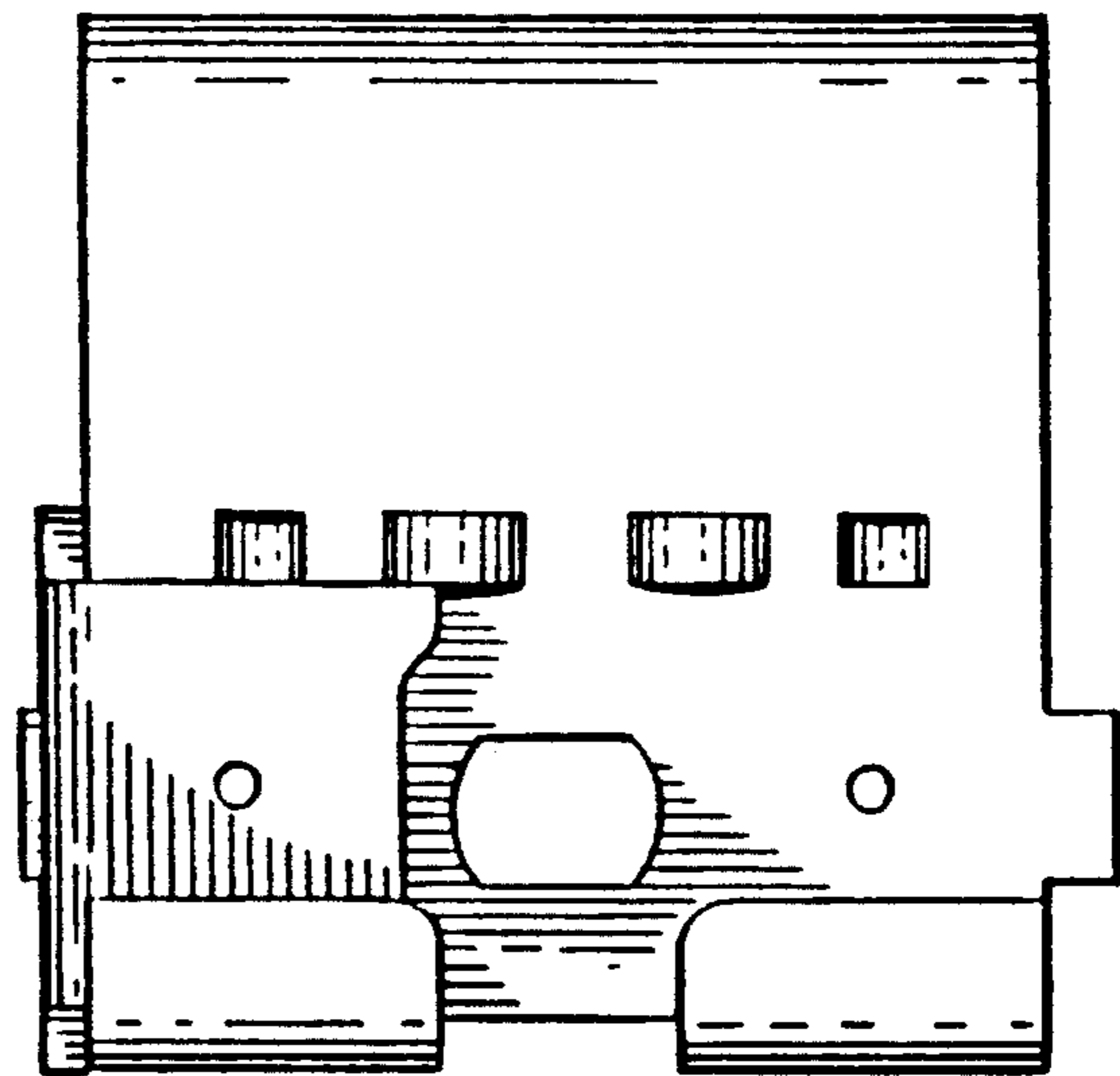

Fig. 10

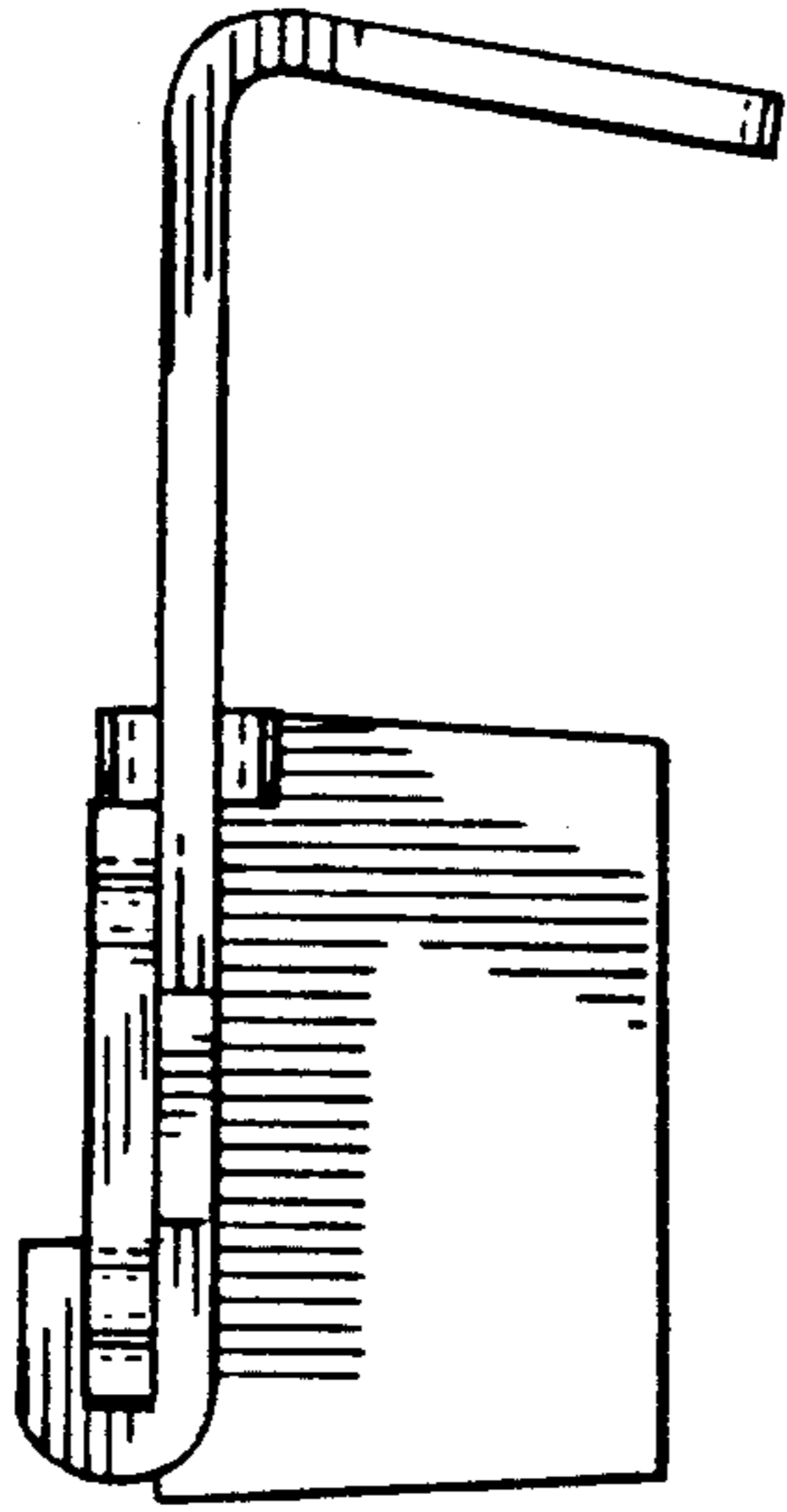

Fig. 11

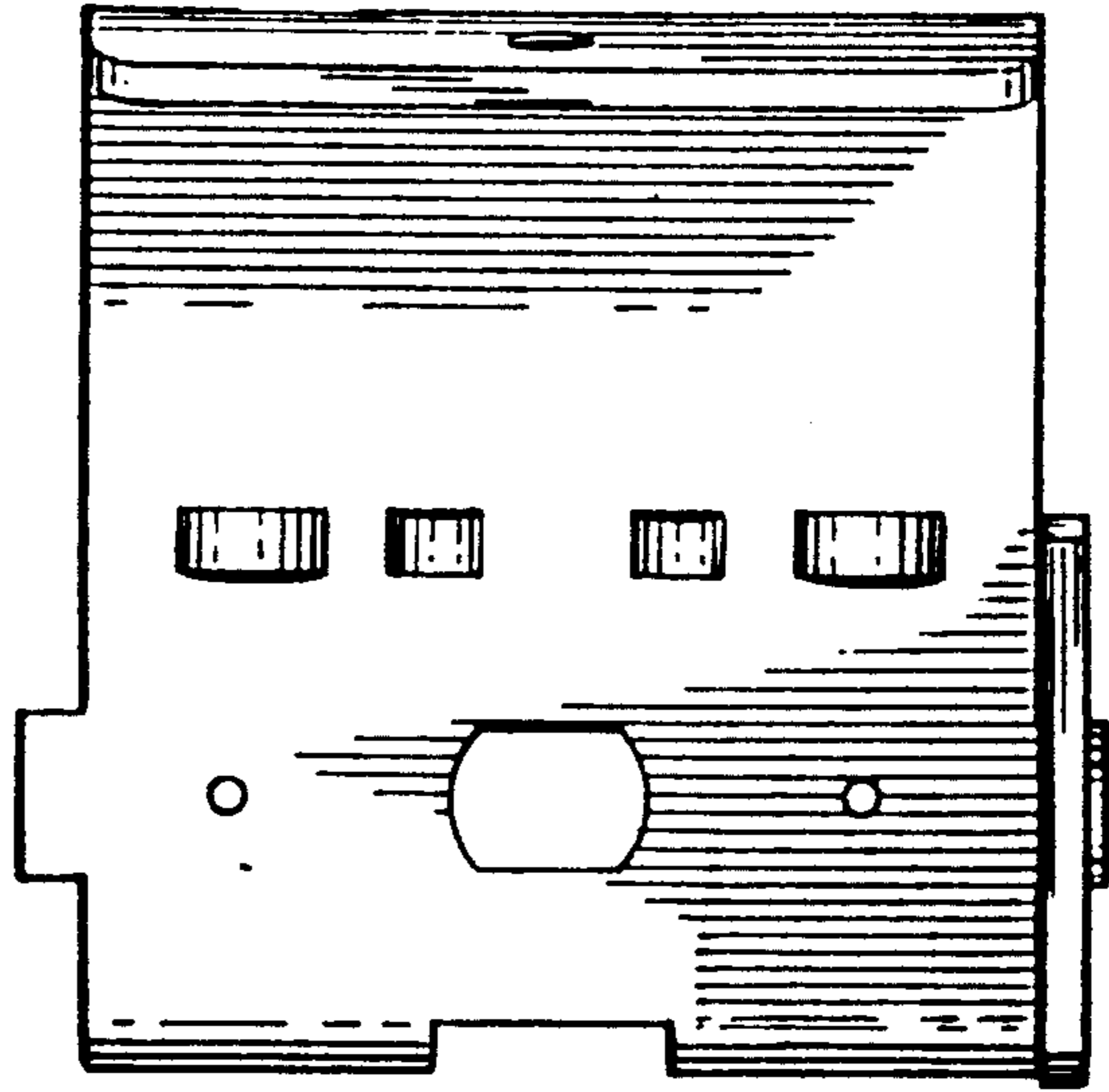

Fig. 12

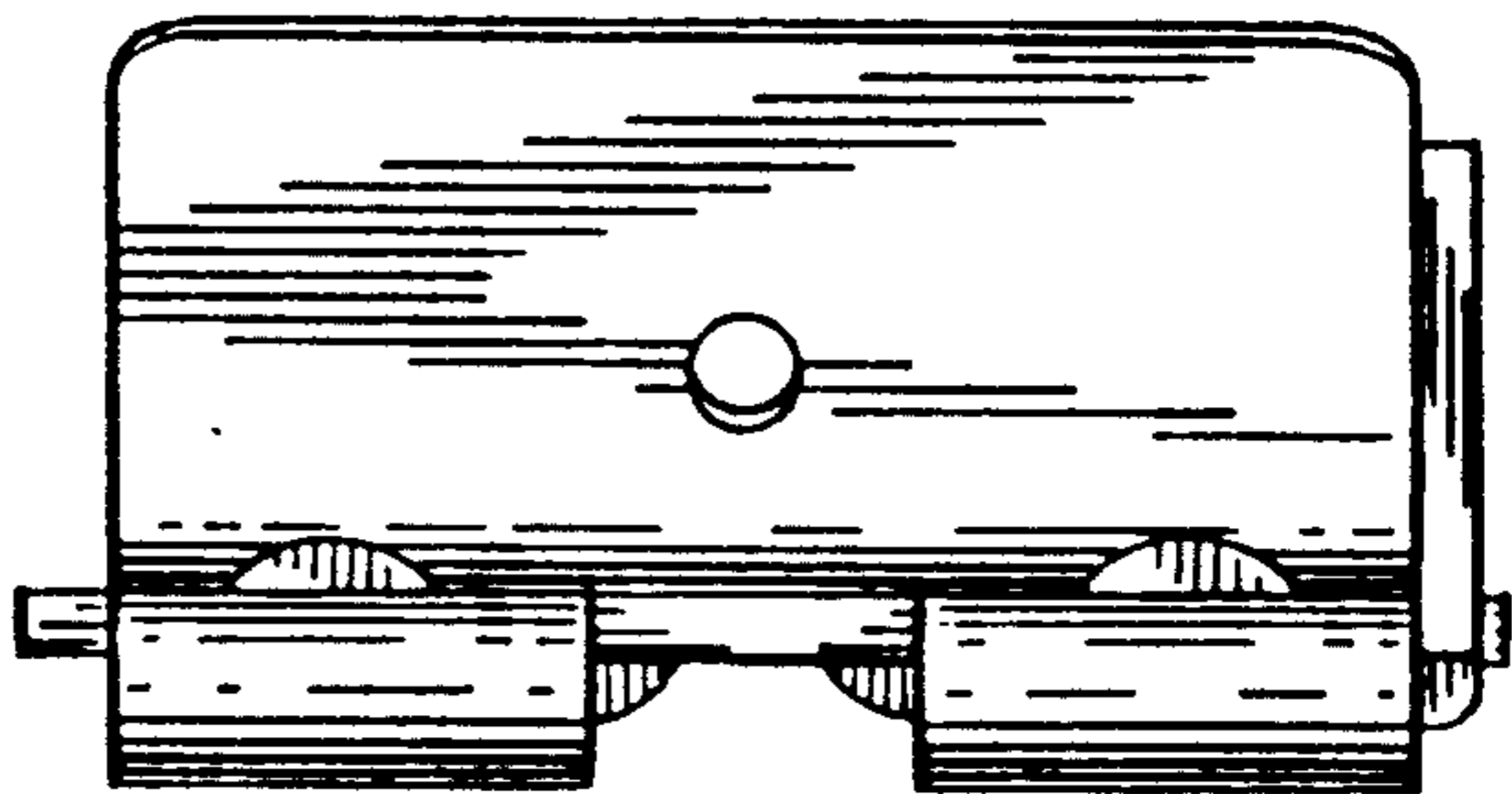

Fig. 14

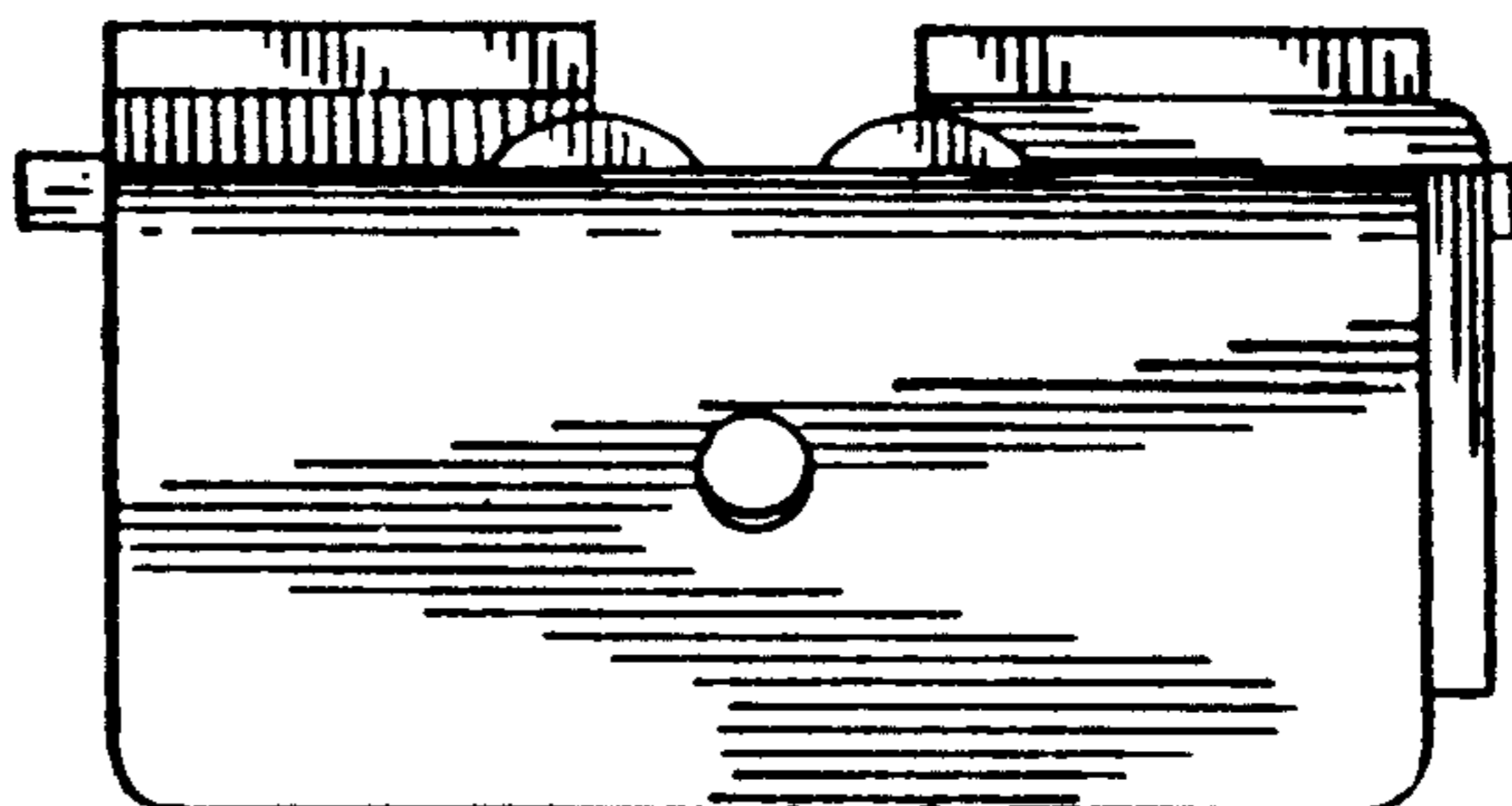

Fig. 13