



US00D343243S

# United States Patent [19]

Ewing et al.

[11] Patent Number: **Des. 343,243**

[45] Date of Patent: **\*\* Jan. 11, 1994**

[54] **POLE MOUNTED STREET LUMINAIRE**

4,434,455 2/1984 Merrett ..... 362/431 X

[75] Inventors: **Robert L. Ewing, Newark; Richard A. Peterson, Columbus, both of Ohio**

[73] Assignee: **Holophane Company, Inc., Newark, Ohio**

[\*\*] Term: **14 Years**

[21] Appl. No.: **843,978**

[22] Filed: **Feb. 27, 1992**

[52] U.S. Cl. .... **D26/67**

[58] Field of Search ..... 362/153.1, 431, 362, 362/363, 367; D26/67-71

[56] **References Cited**

**U.S. PATENT DOCUMENTS**

|            |        |                   |         |
|------------|--------|-------------------|---------|
| D. 300,670 | 4/1989 | Ewing et al. .... | D26/67  |
| D. 302,330 | 7/1989 | Fretz .....       | D26/67  |
| 1,573,580  | 2/1926 | Ruttle .....      | 362/363 |

**OTHER PUBLICATIONS**

Sun Valley Lighting Standards Preview Catalog, 1987, p. 3, Luminaire #LAC1.

*Primary Examiner*—Susan J. Lucas  
*Attorney, Agent, or Firm*—Brooks & Kushman

[57] **CLAIM**

The ornamental design for a pole mounted street luminaire, as shown and described.

**DESCRIPTION**

FIG. 1 is a perspective view of our new design; FIG. 2 is a front elevational view; FIG. 3 is a left side elevational view; FIG. 4 is a right side elevational view; FIG. 5 is a top plan view; and, FIG. 6 is a rear elevational view. The broken lines are shown for illustrative purposes only and form no part of the claimed design.

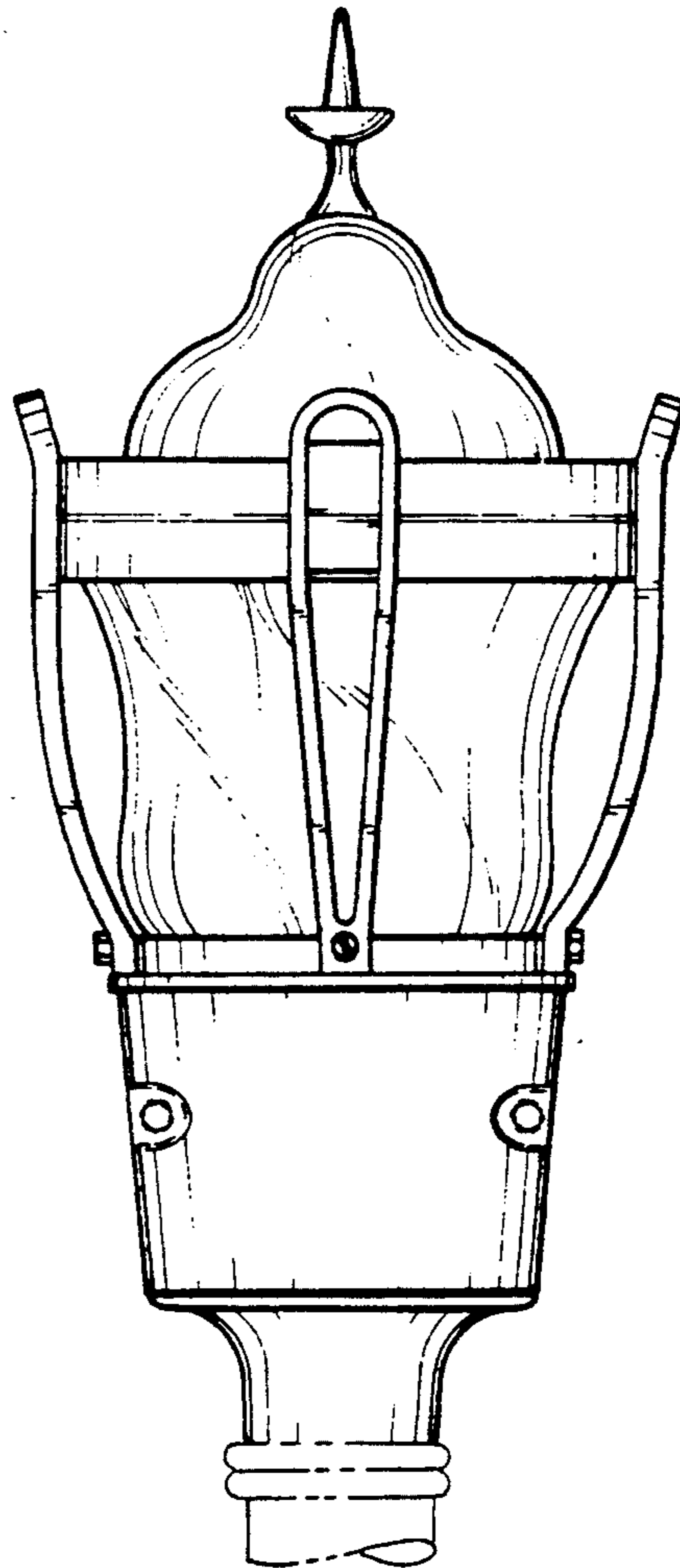
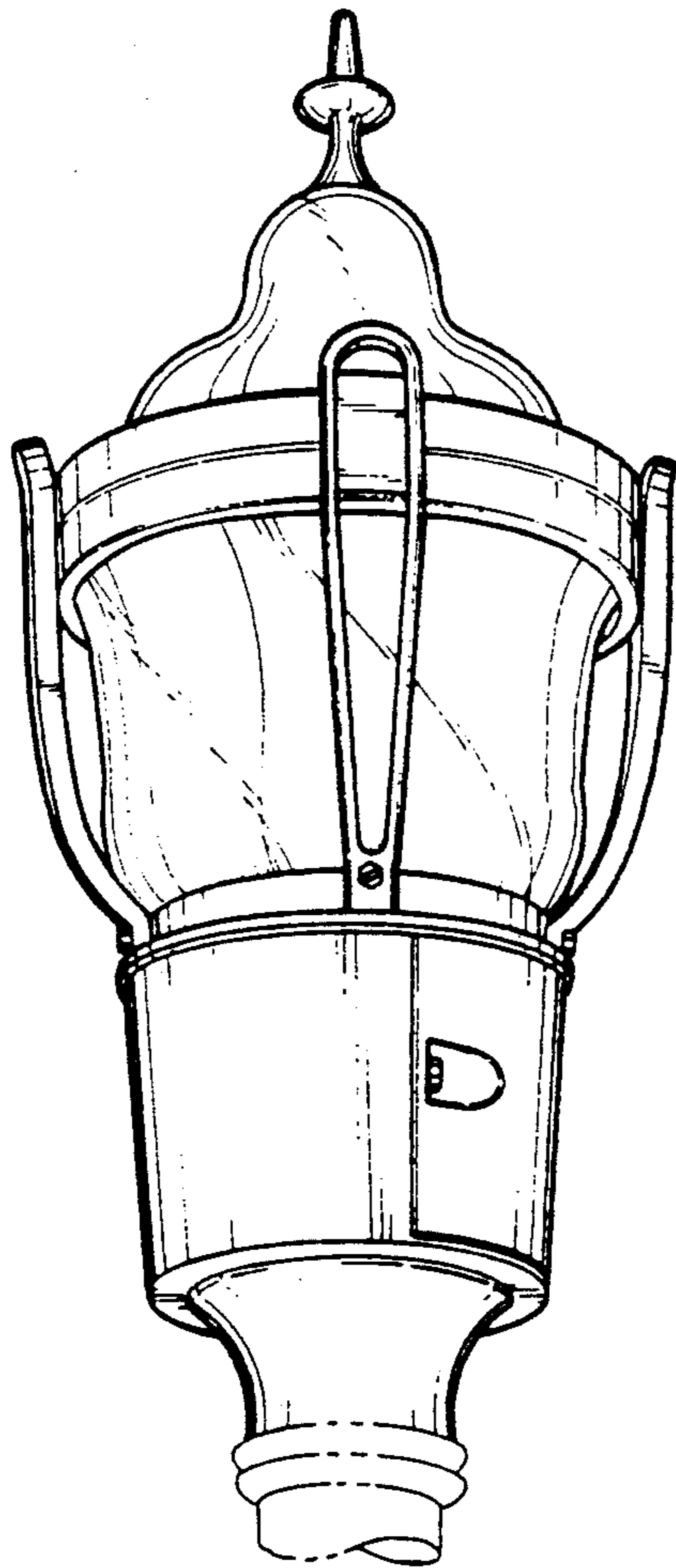

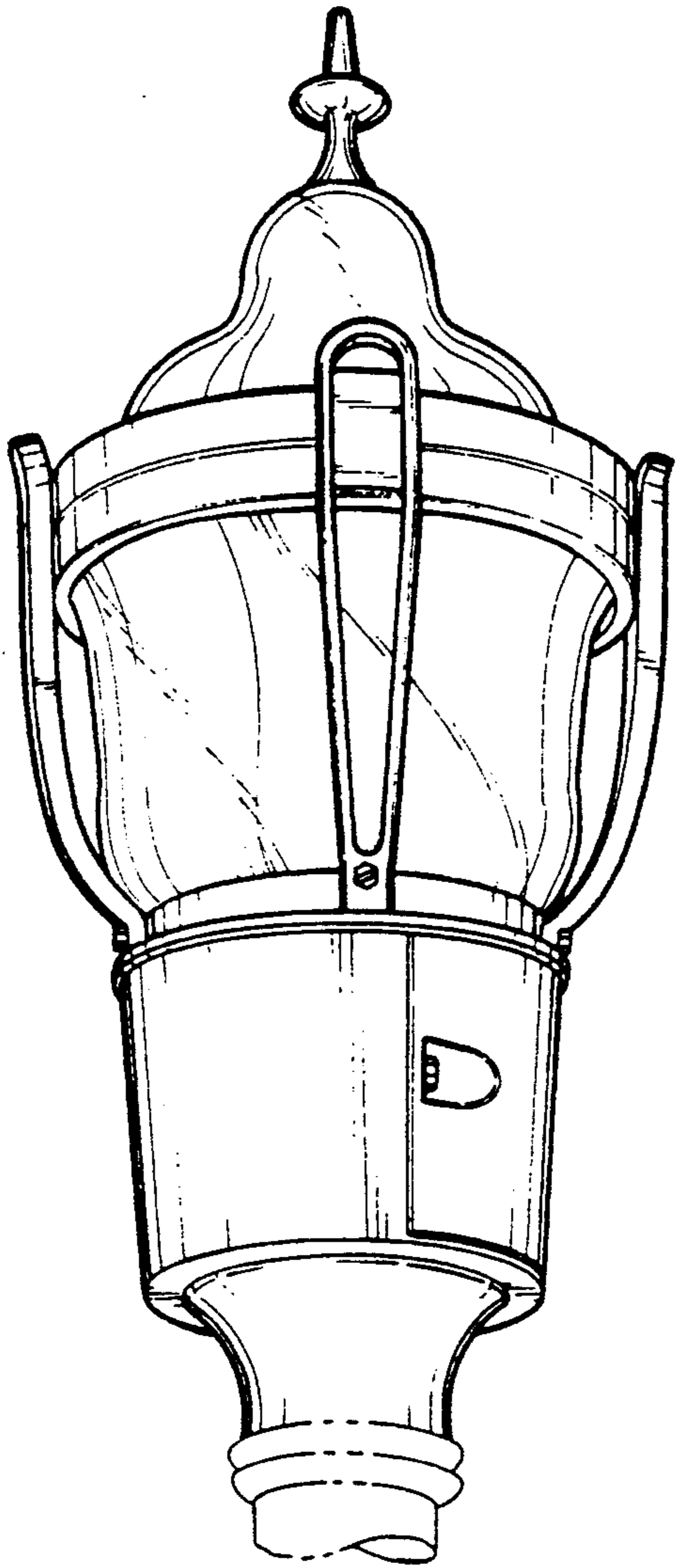

fig-1

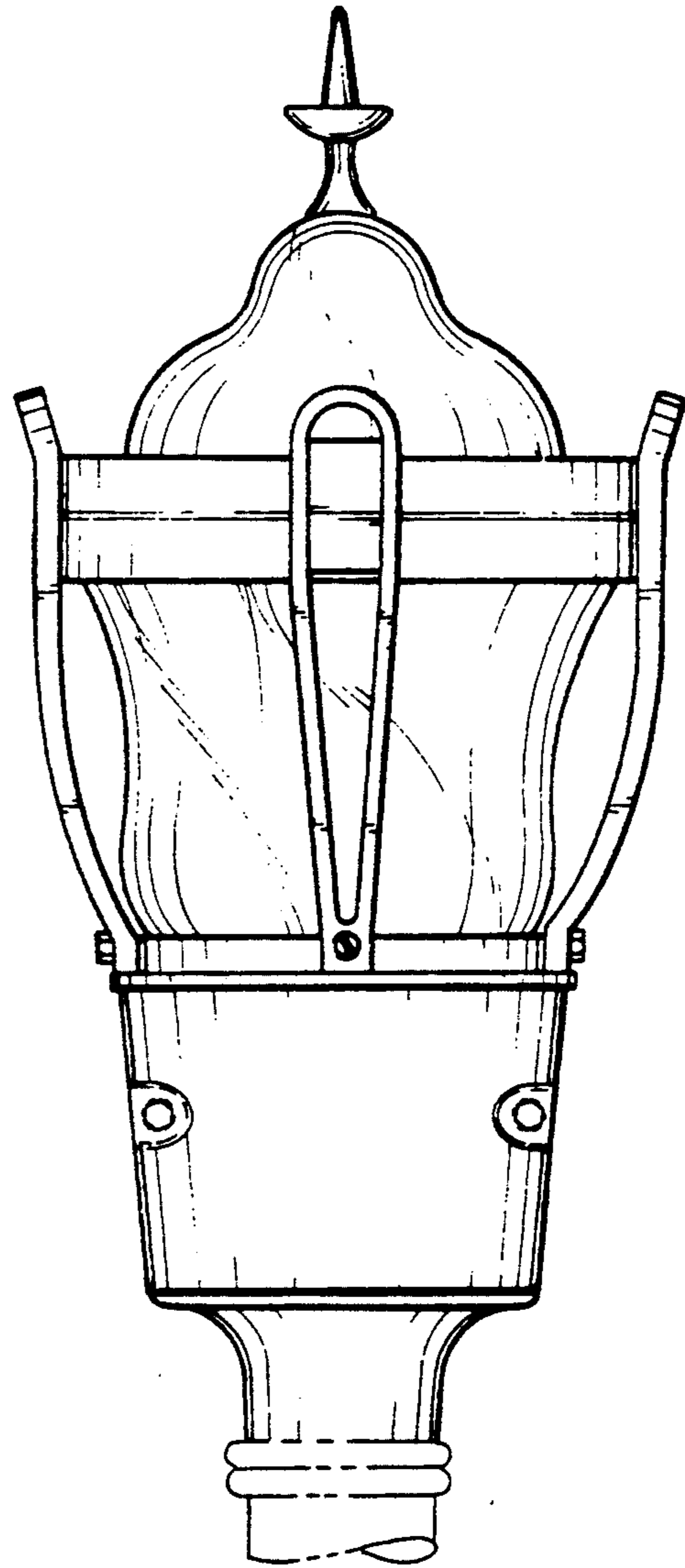

fig-2

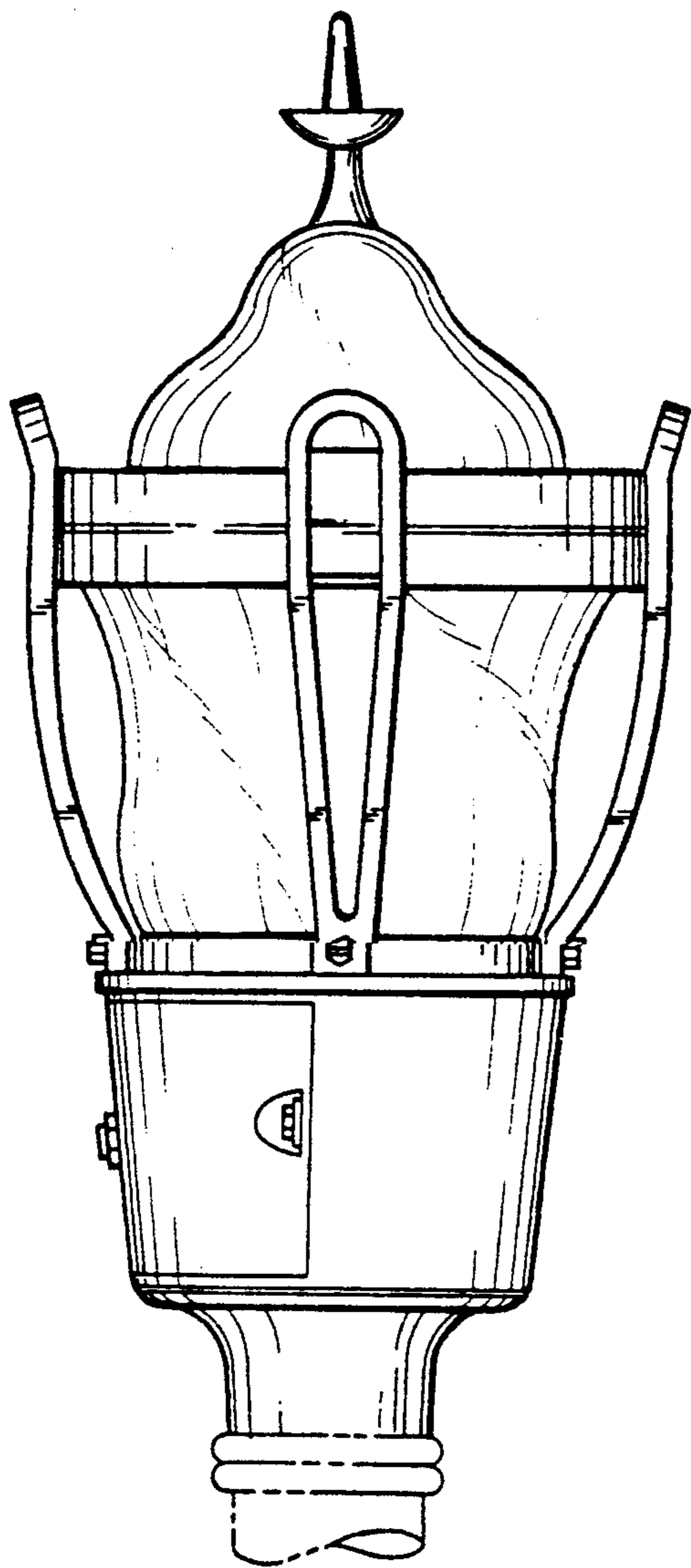

fig-3

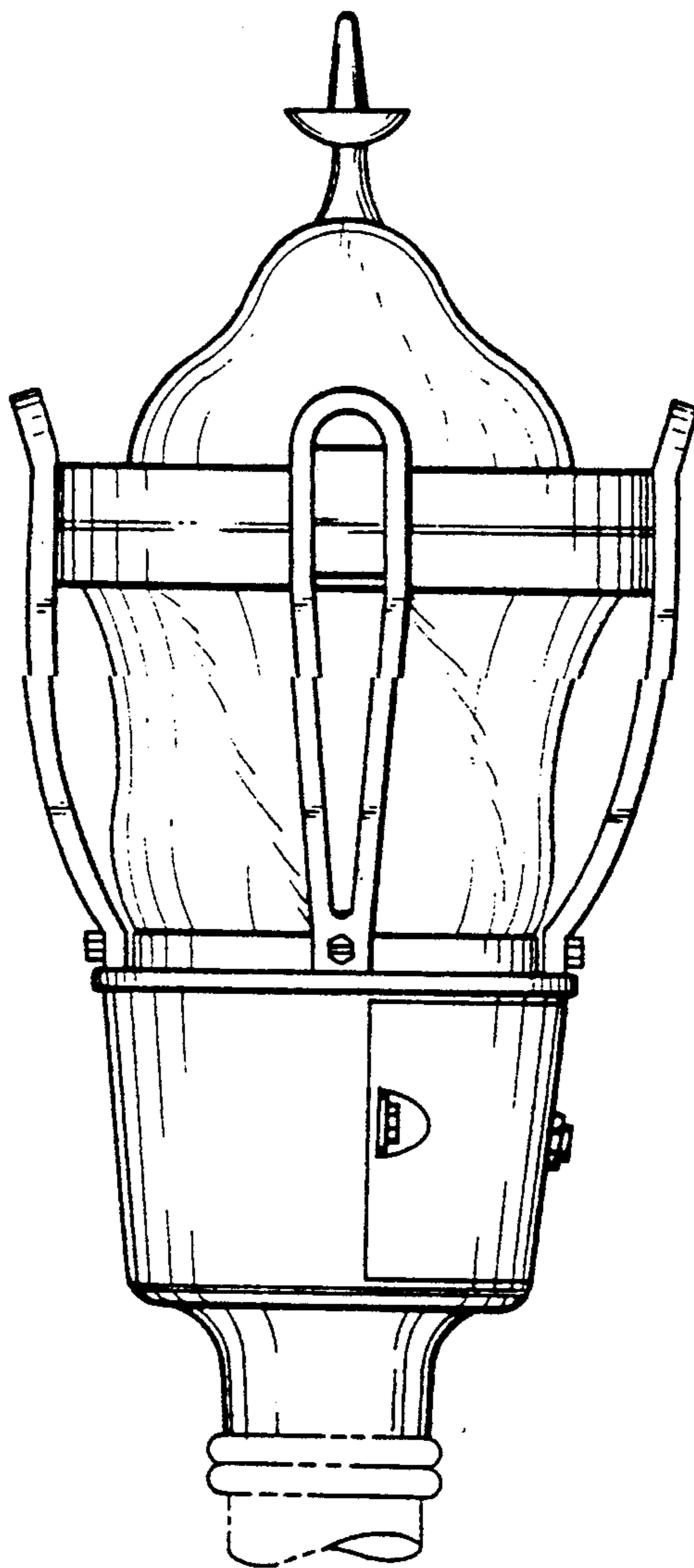

fig-4

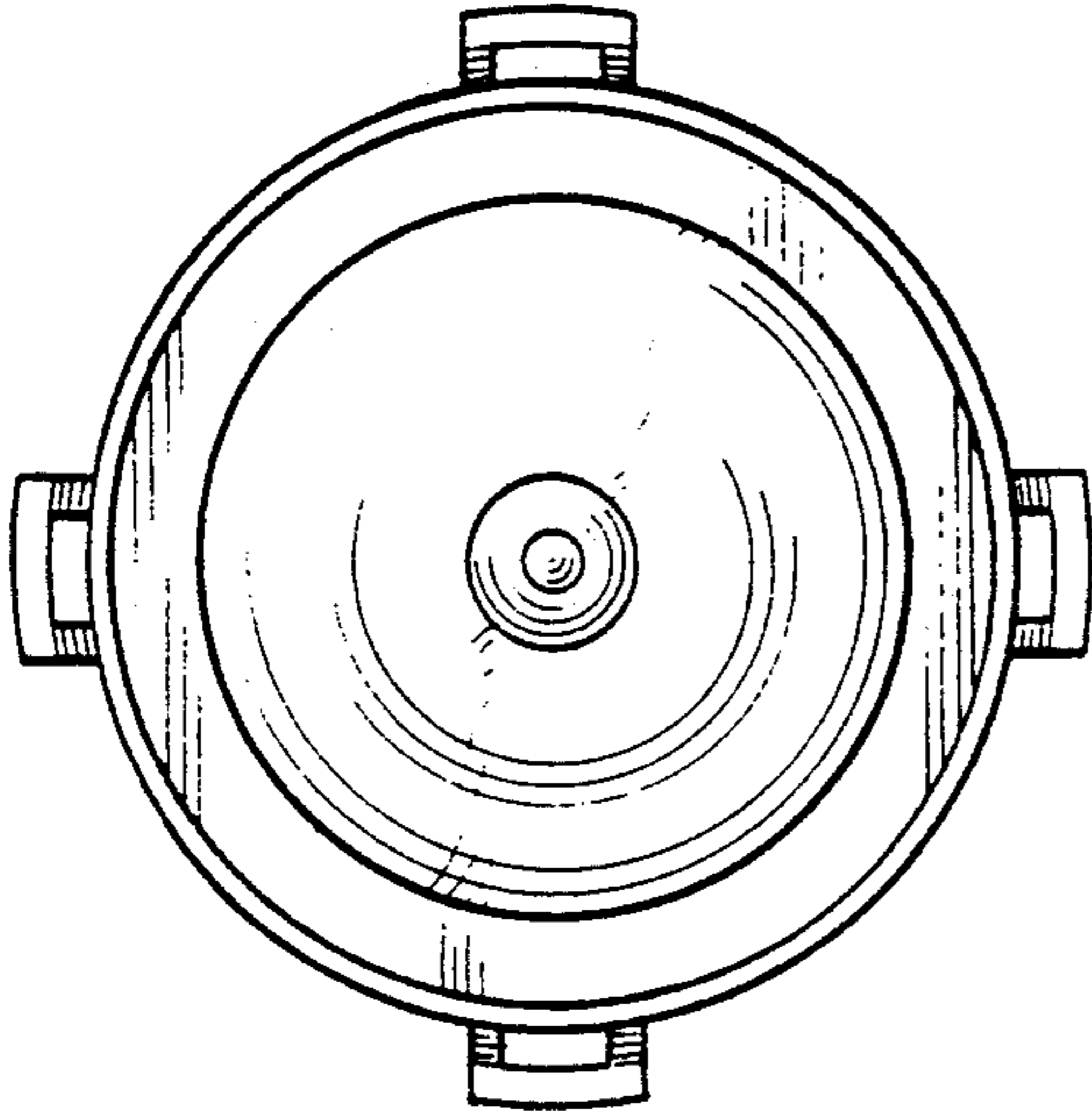

fig-5

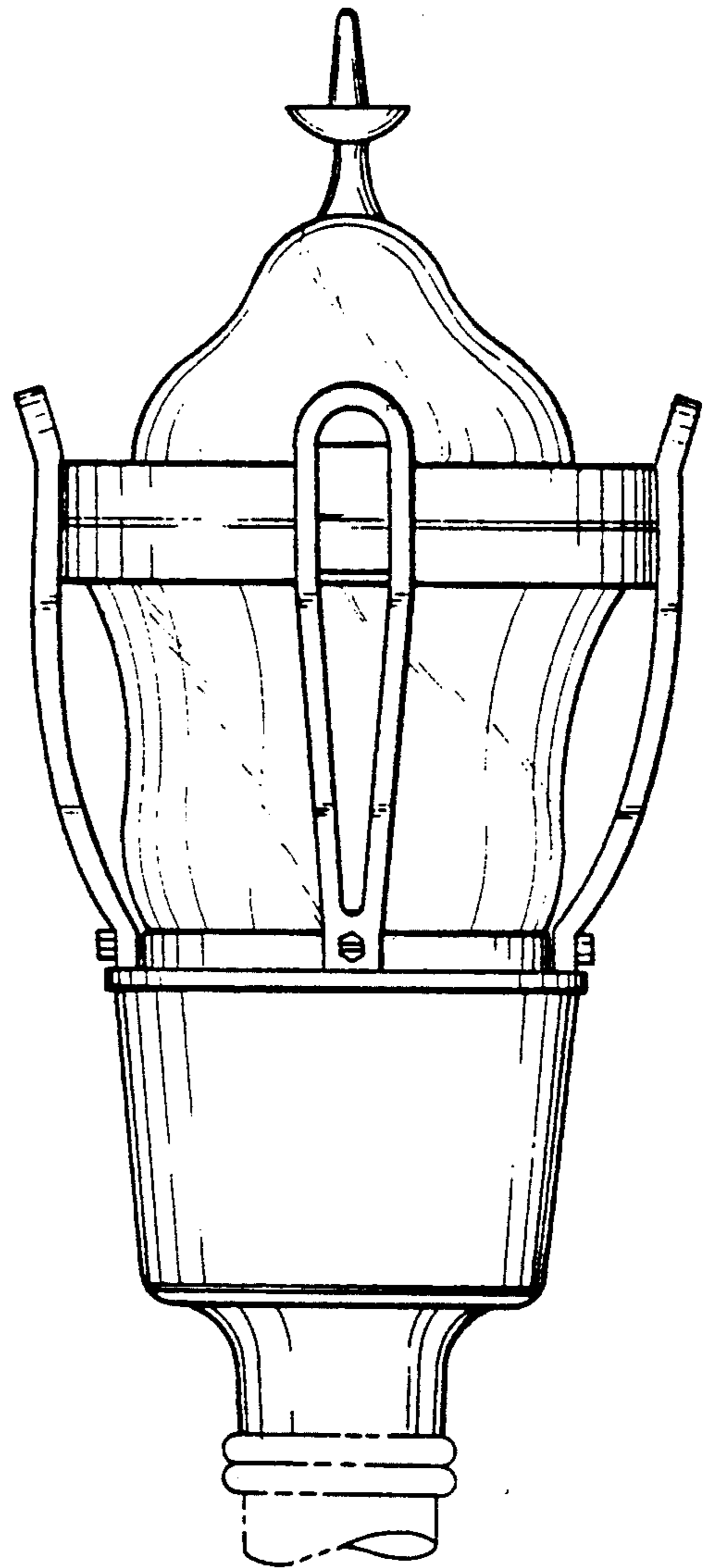

fig-6