



US00D343226S

# United States Patent [19] Shields

[11] Patent Number: **Des. 343,226**

[45] Date of Patent: **\*\* Jan. 11, 1994**

[54] **FISHING BOBBER**

[76] Inventor: **Steve L. Shields, P.O. Box 1195,  
Lincoln, Calif. 95648**

[\*\*] Term: **14 Years**

[21] Appl. No.: **688,987**

[22] Filed: **Apr. 22, 1991**

[52] U.S. Cl. .... **D22/146; D22/145**

[58] Field of Search ..... **43/44.9, 44.91, 44.92,  
43/44.93, 43.13, 43.11, 44.87, 44.94, 42.39, 43.1;  
D22/145, 146**

4,086,719 5/1978 Robbins ..... 43/44.9  
 4,138,793 2/1979 Kellie ..... 43/44.92 X  
 4,837,968 6/1989 Lin ..... 43/44.97 X

*Primary Examiner*—James R. Largen  
*Assistant Examiner*—Doris V. Coles  
*Attorney, Agent, or Firm*—S. Michael Bender

[57] **CLAIM**

The ornamental design for a fishing bobber, as shown and described.

**DESCRIPTION**

FIG. 1 is a front elevational view of the fishing bobber showing my new design;  
 FIG. 2 is a rear elevational view thereof;  
 FIG. 3 is a left side elevational view thereof;  
 FIG. 4 is a right side elevational view thereof;  
 FIG. 5 is a top plan view thereof;  
 FIG. 6 is a bottom plan view thereof; and,  
 FIG. 7 is a perspective view thereof.

[56] **References Cited**

**U.S. PATENT DOCUMENTS**

D. 291,589 8/1987 Kerscher ..... D22/146  
 2,813,367 11/1957 Jackson ..... D22/145  
 2,828,572 4/1958 Sargent ..... 43/42.39  
 2,887,816 5/1959 Hudkins ..... D22/146 X  
 2,968,114 1/1961 Spierer ..... D22/145 X

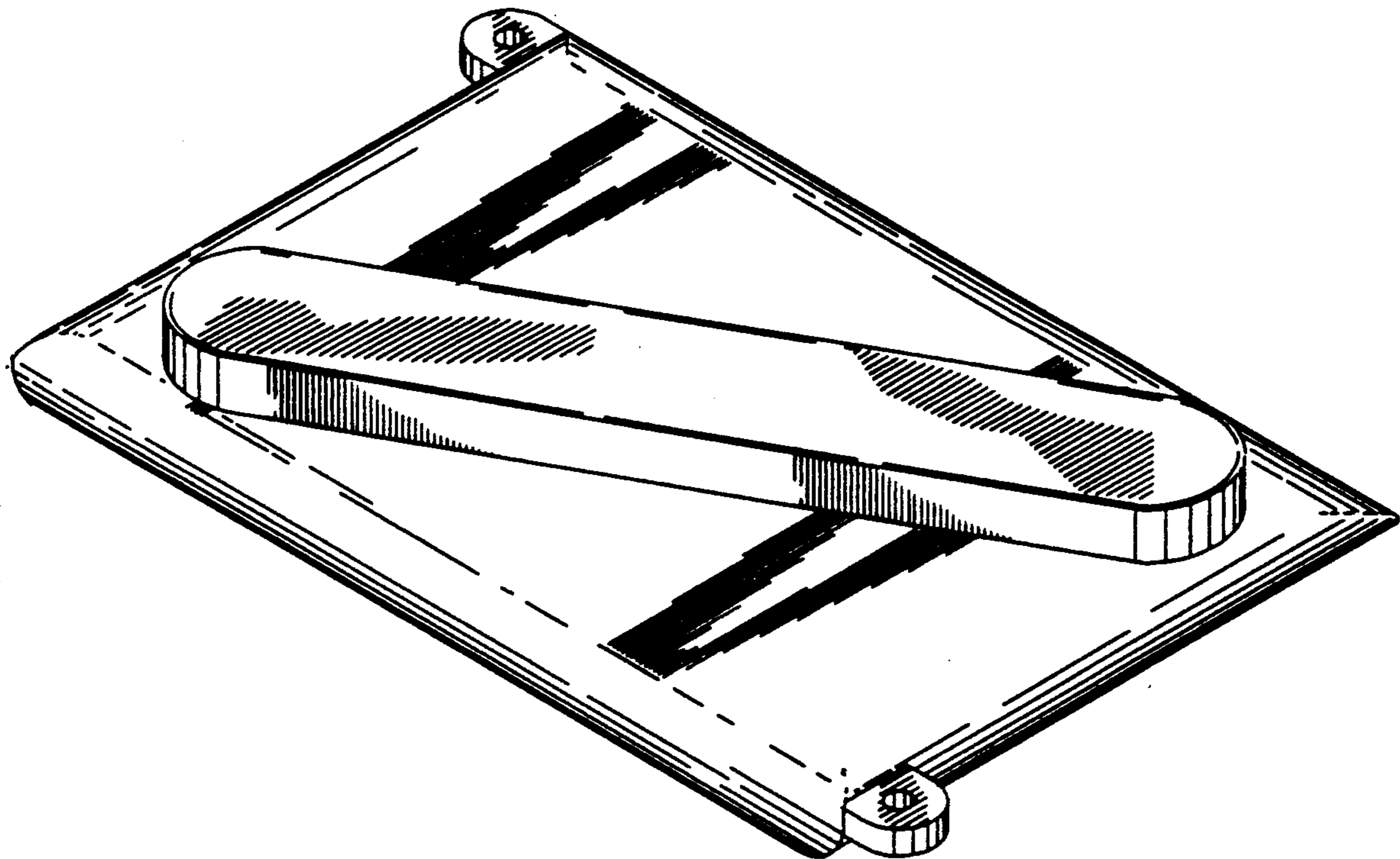

*FIG. 1*

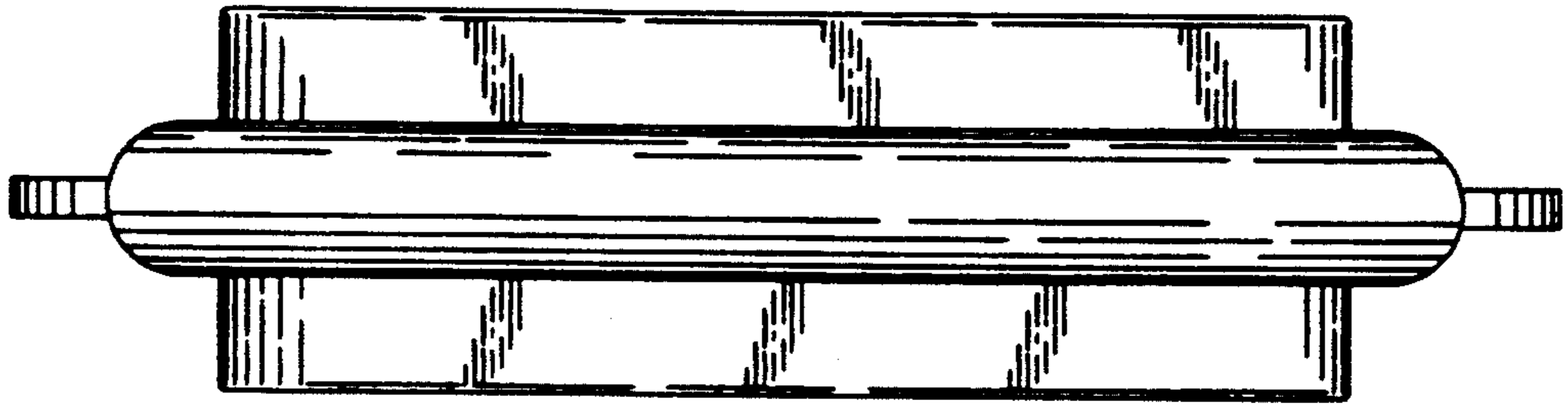

*FIG. 2*

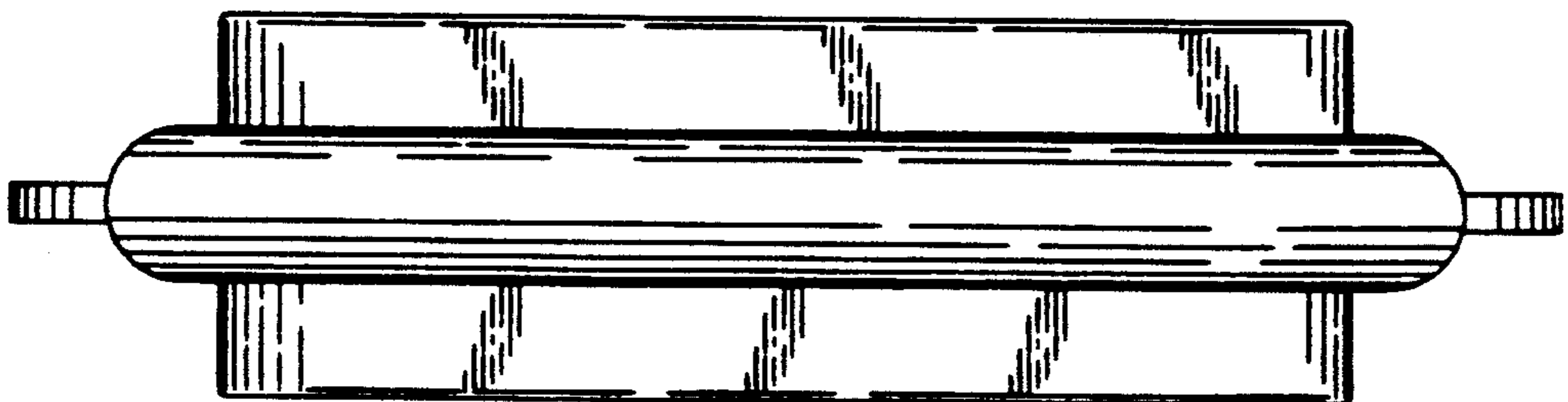

*FIG. 3*

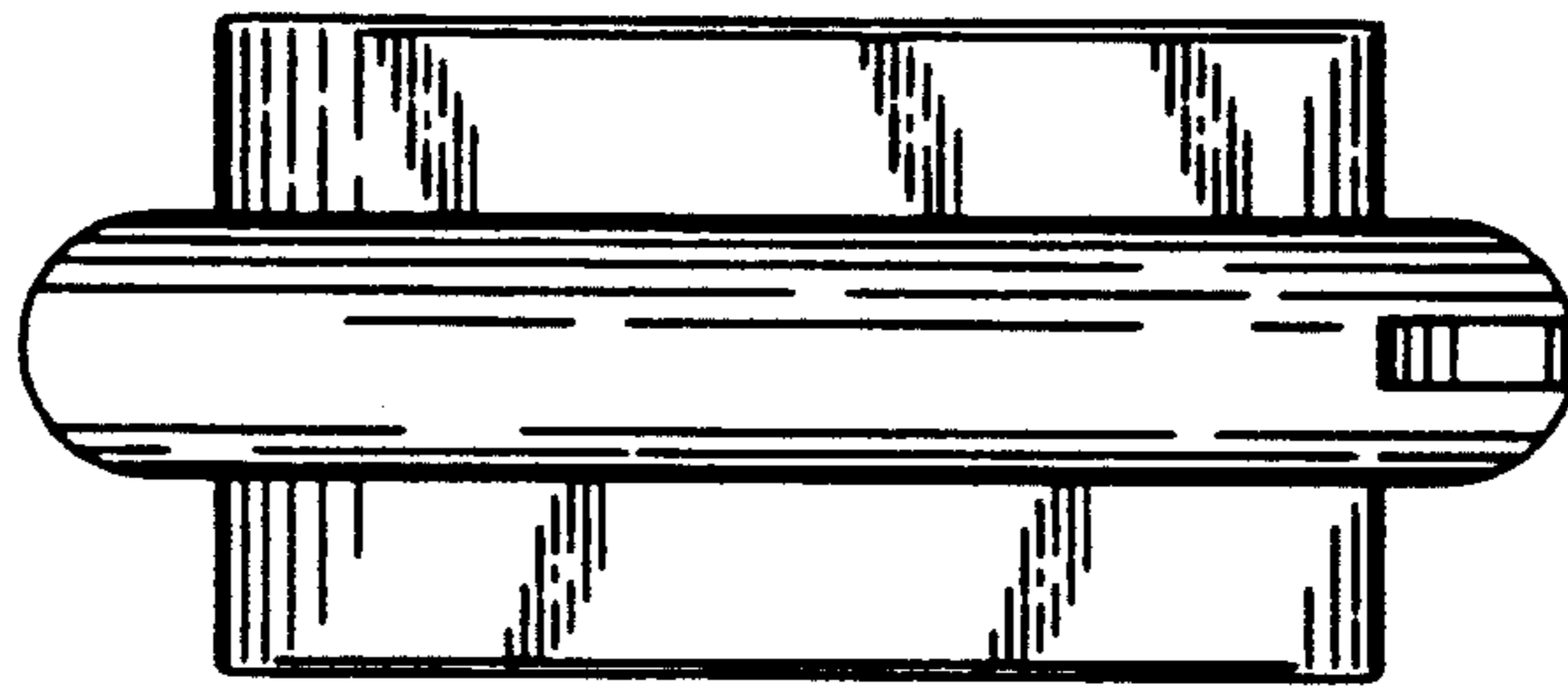

*FIG. 4*

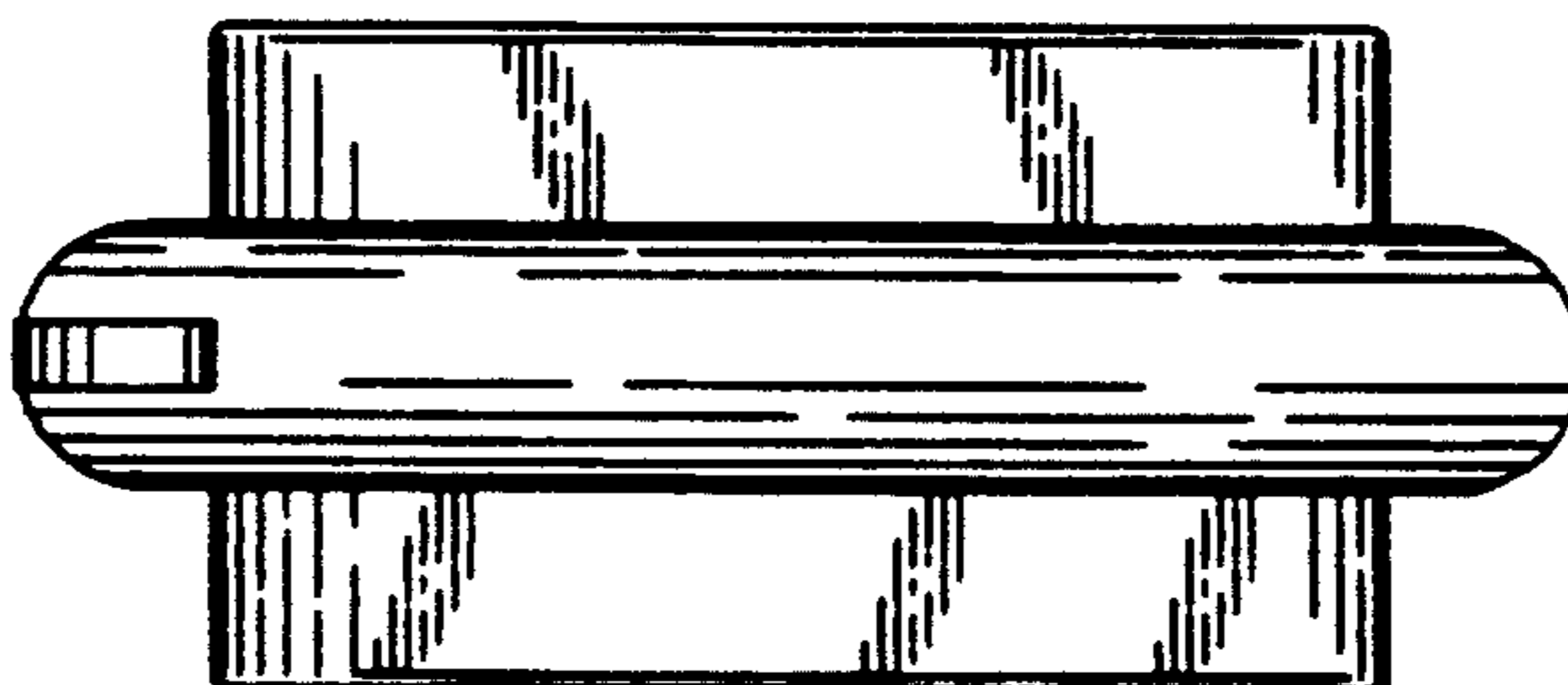

FIG. 5

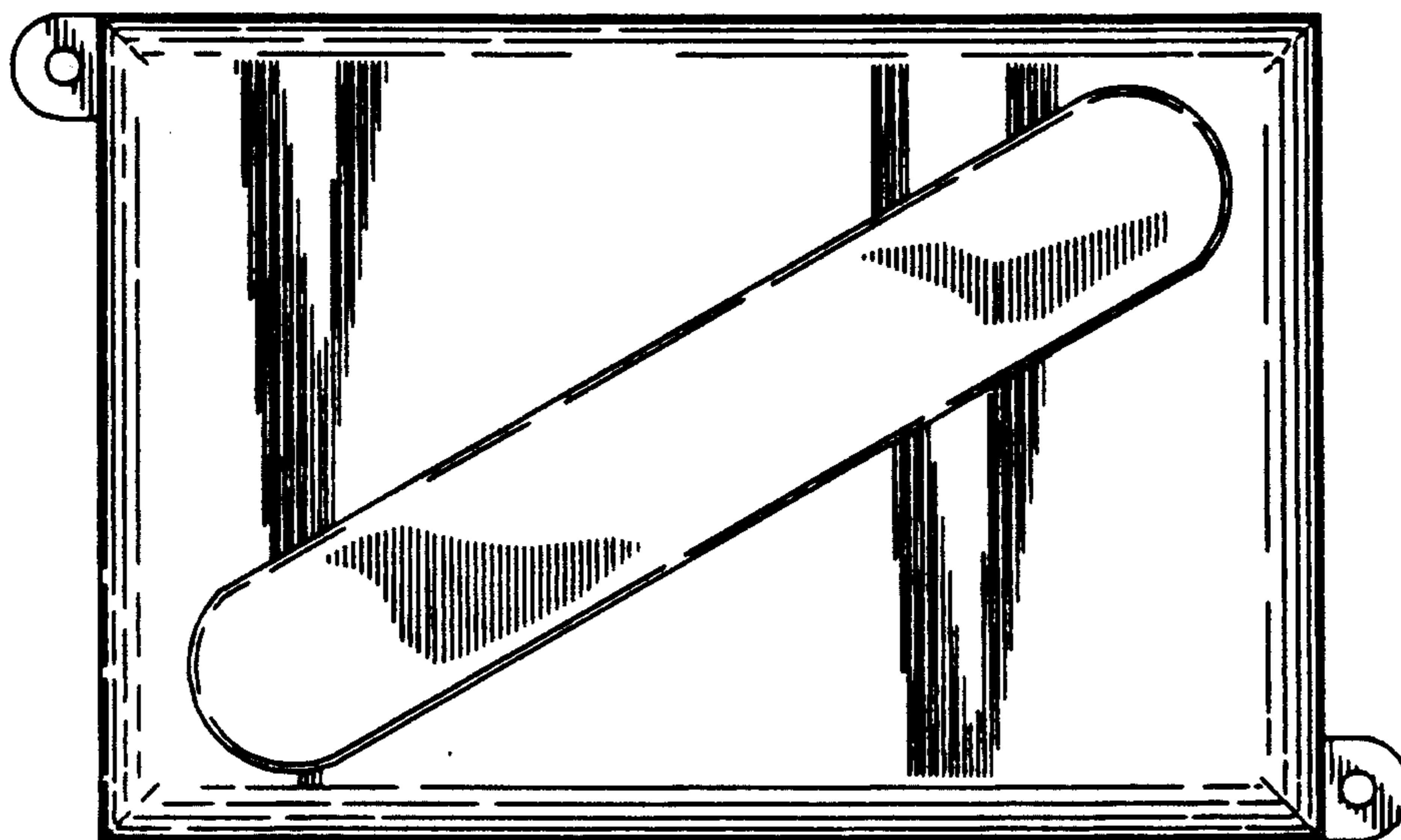

FIG. 6

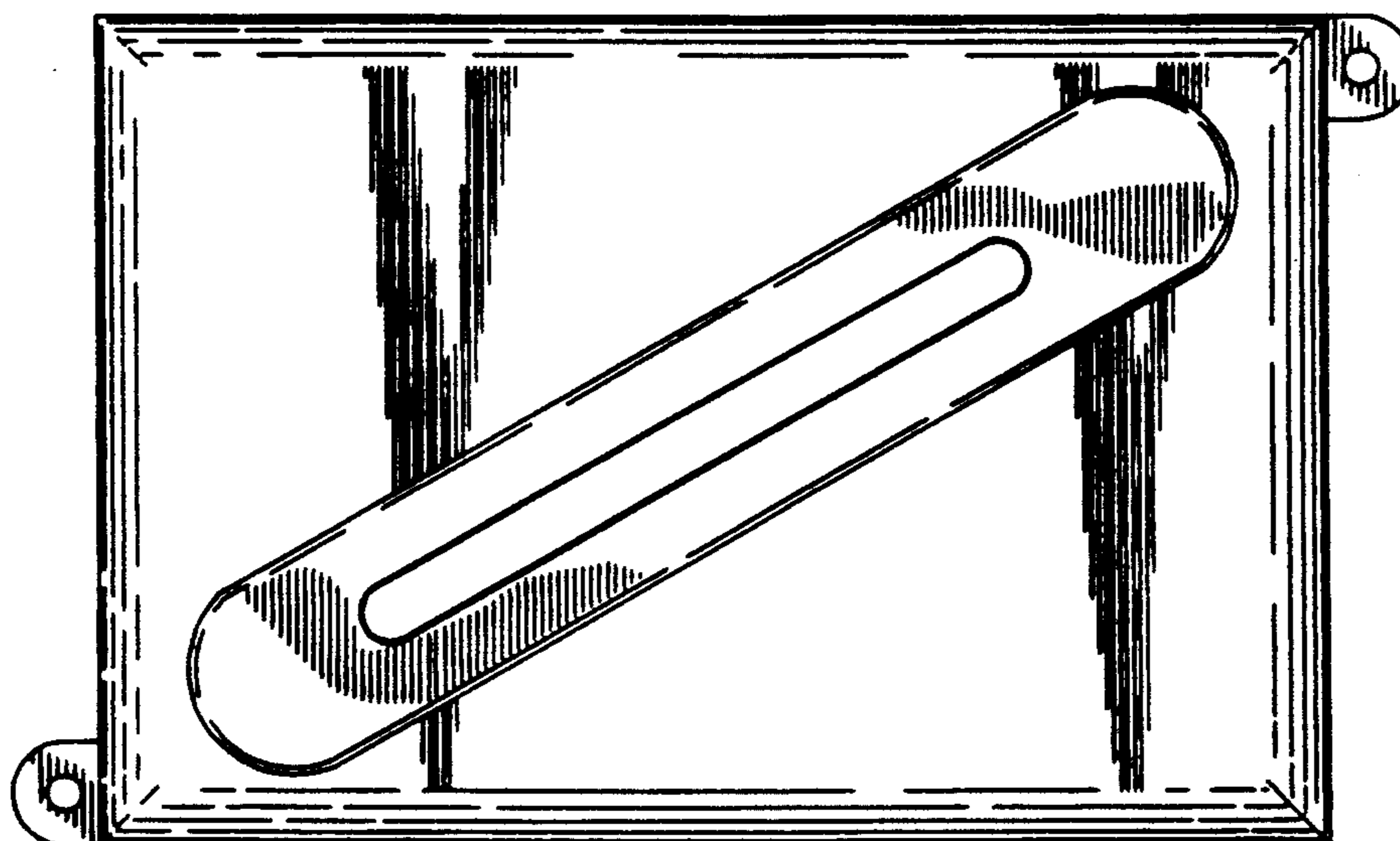

FIG. 7

