



US00D343221S

**United States Patent** [19]  
**Fields**

[11] **Patent Number: Des. 343,221**  
[45] **Date of Patent: \*\* Jan. 11, 1994**

[54] **CHANGEABLE GUN STOCK**

[76] **Inventor: David W. Fields, 9012 R.D. 228, Terra Bella, Calif. 93270**

[\*\*] **Term: 14 Years**

[21] **Appl. No.: 601,177**

[22] **Filed: Oct. 18, 1990**

[52] **U.S. Cl. .... D22/108; D22/103; D22/104**

[58] **Field of Search ..... D8/331; 42/71.02, 54, 42/76.01, 59, 102, 69.01, 65; D22/108, 103, 104**

[56] **References Cited**

**U.S. PATENT DOCUMENTS**

D. 299,673	1/1989	Knight .....	D22/103
1,323,151	11/1919	Burton .....	42/102
4,854,065	8/1989	French et al. ....	42/65

**OTHER PUBLICATIONS**

The Fastener Book, a Penton Publication, pp. 144 and 147, Sep. 29, 1960, Faspin and Dowel Pins.

*Primary Examiner*—A. Hugo Word  
*Assistant Examiner*—Doris V. Coles  
*Attorney, Agent, or Firm*—S. Michael Bender

[57] **CLAIM**

The ornamental design for a changeable gun stock, as shown and described.

**DESCRIPTION**

FIG. 1 is a front elevational view of the changeable gun stock showing my new design;  
FIG. 2 is a rear elevational view thereof;  
FIG. 3 is a left side elevational view thereof;  
FIG. 4 is a right side elevational view thereof;  
FIG. 5 is a top plan view thereof;  
FIG. 6 is a bottom plan view thereof; and,  
FIG. 7 is a perspective view thereof, showing the pull pin removed the stock portion.  
The broken line showing of a gun in FIG. 1 is for illustrative purposes only and forms no part of the claimed design.

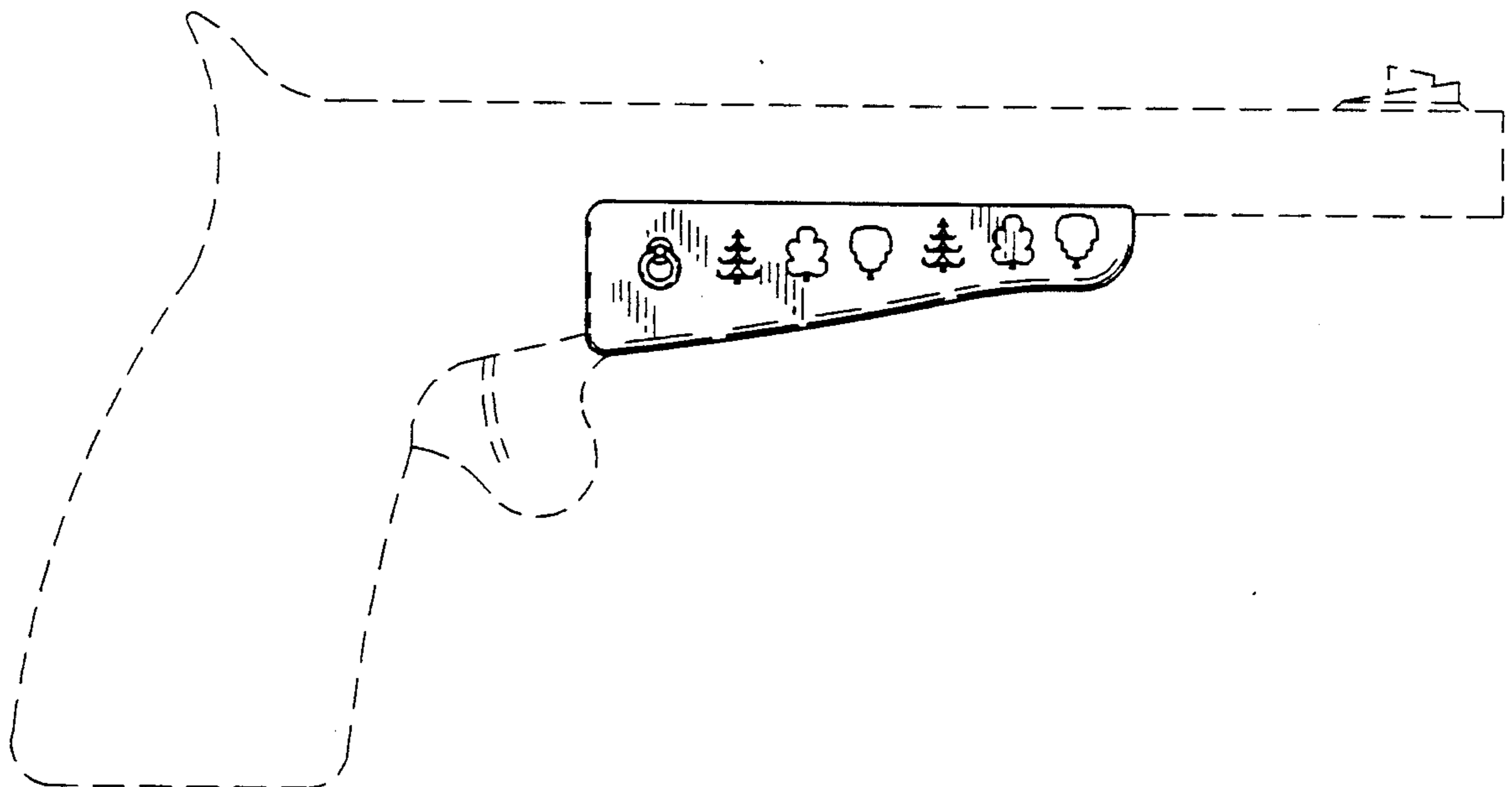

FIG. 1

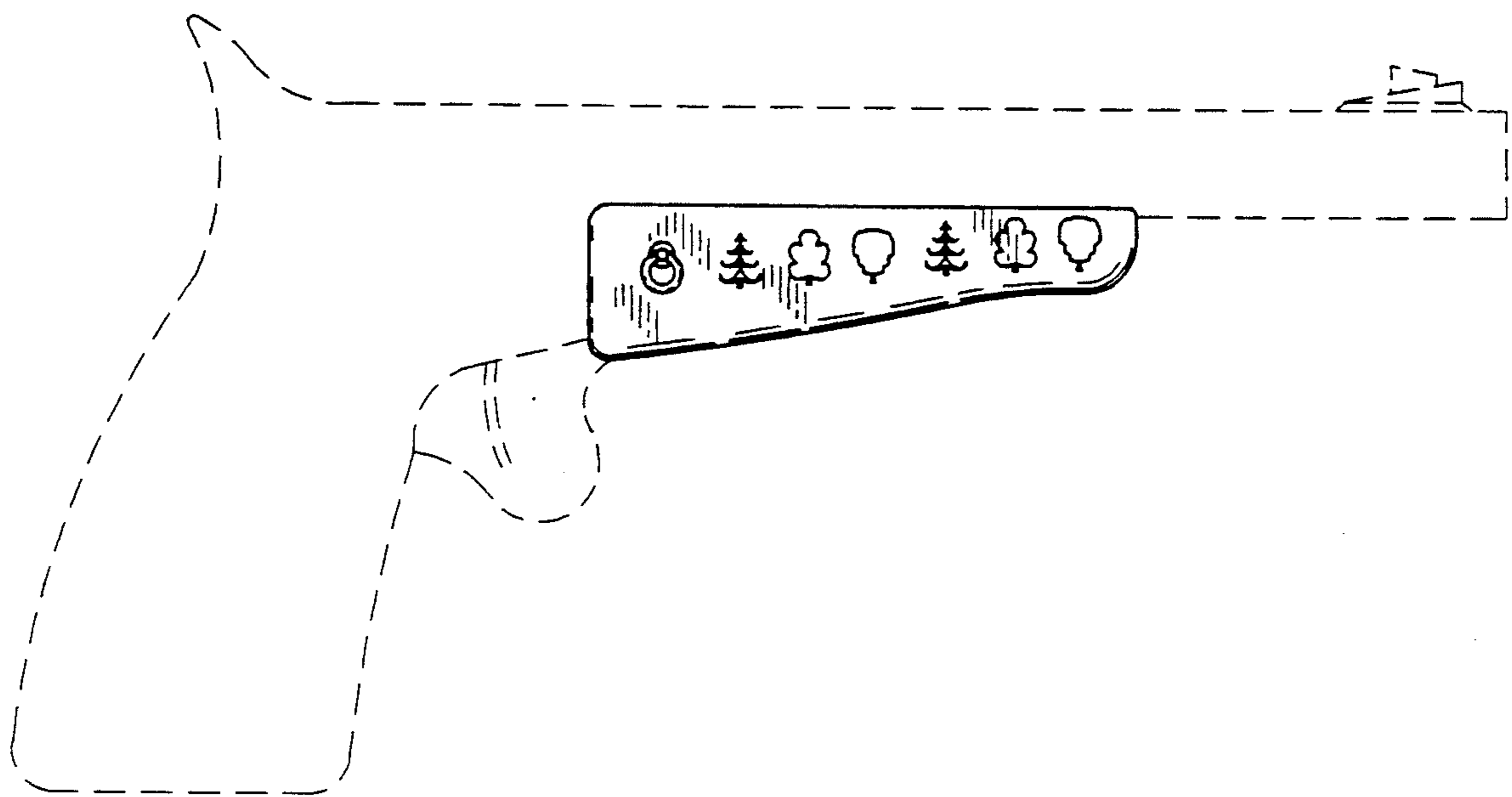

FIG. 2

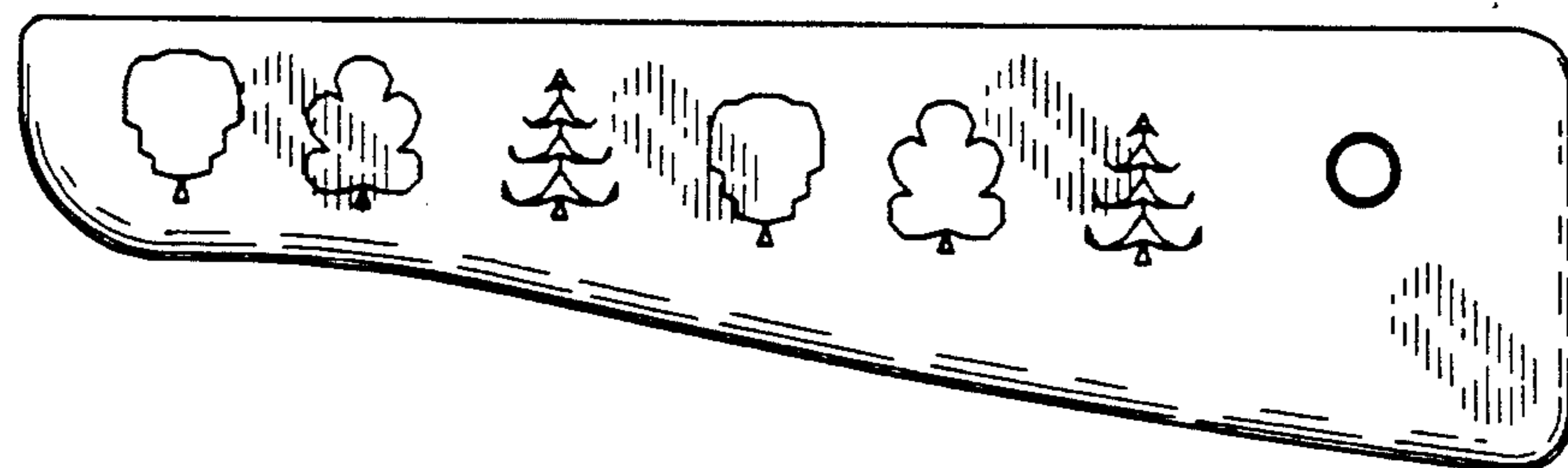

FIG. 3

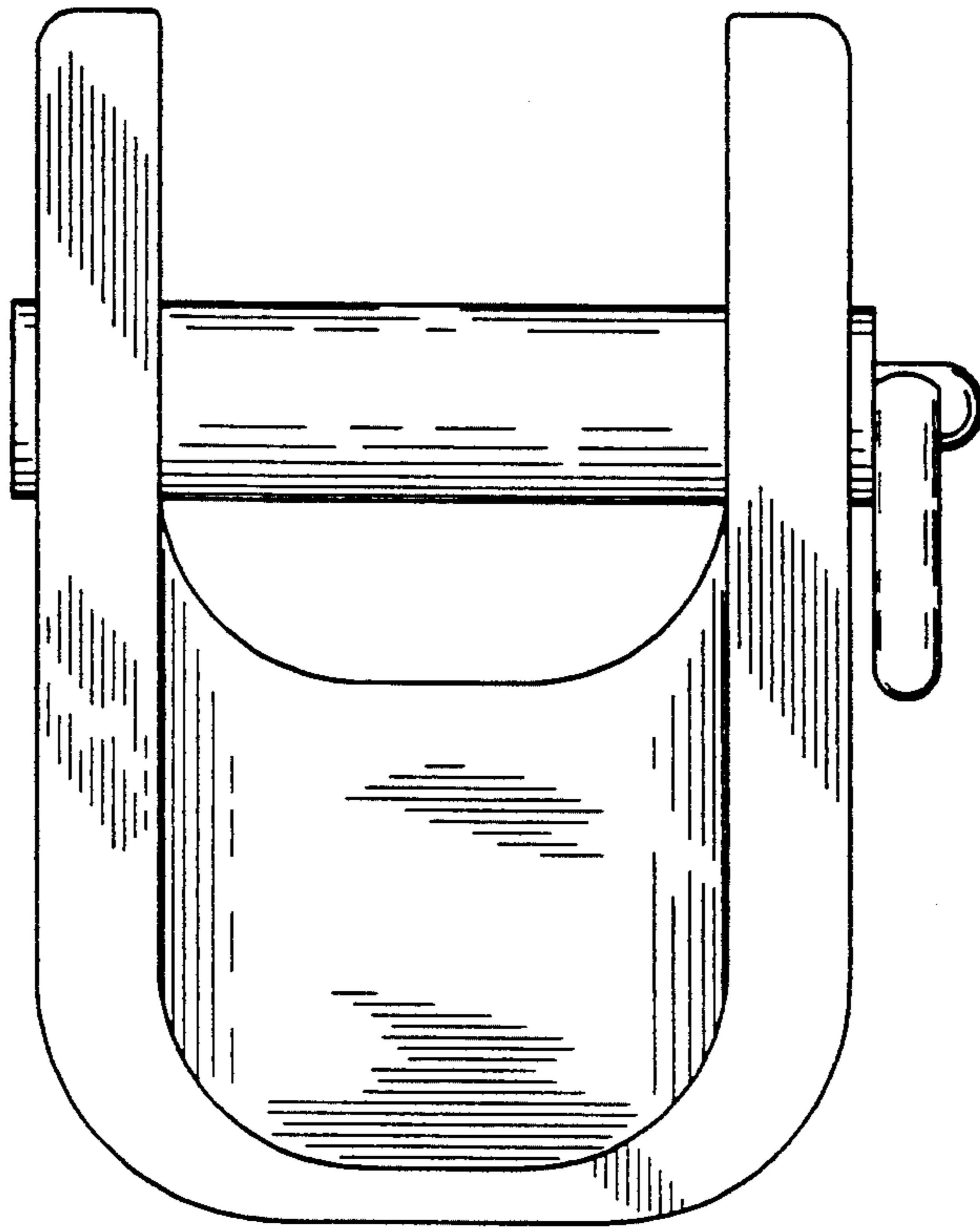
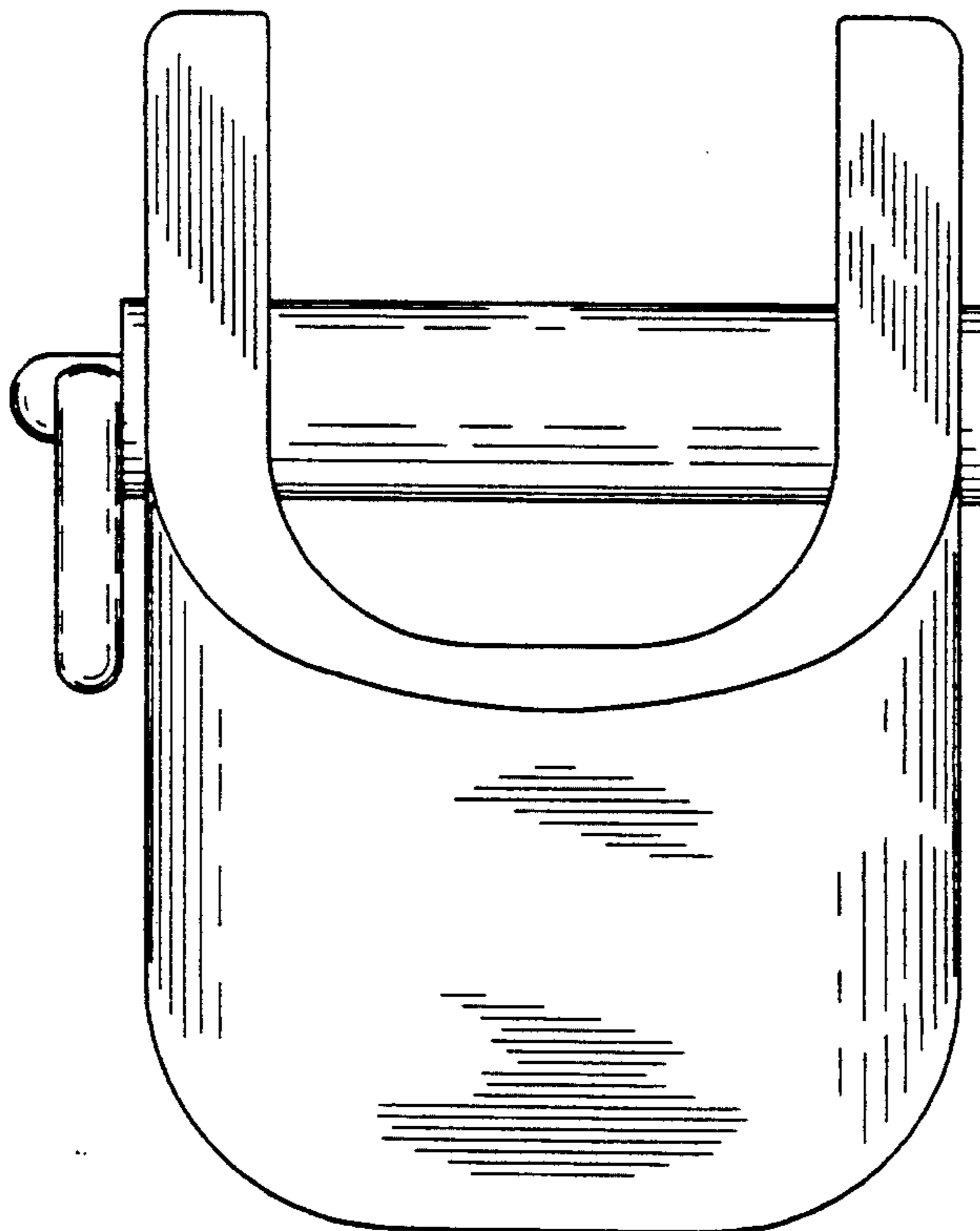
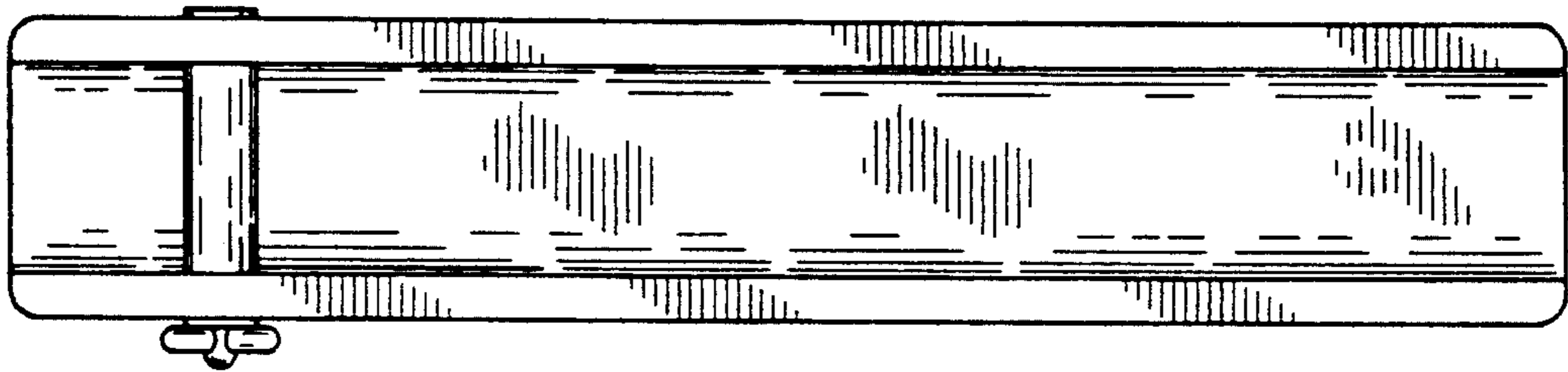

FIG. 4



*FIG. 5*



*FIG. 6*

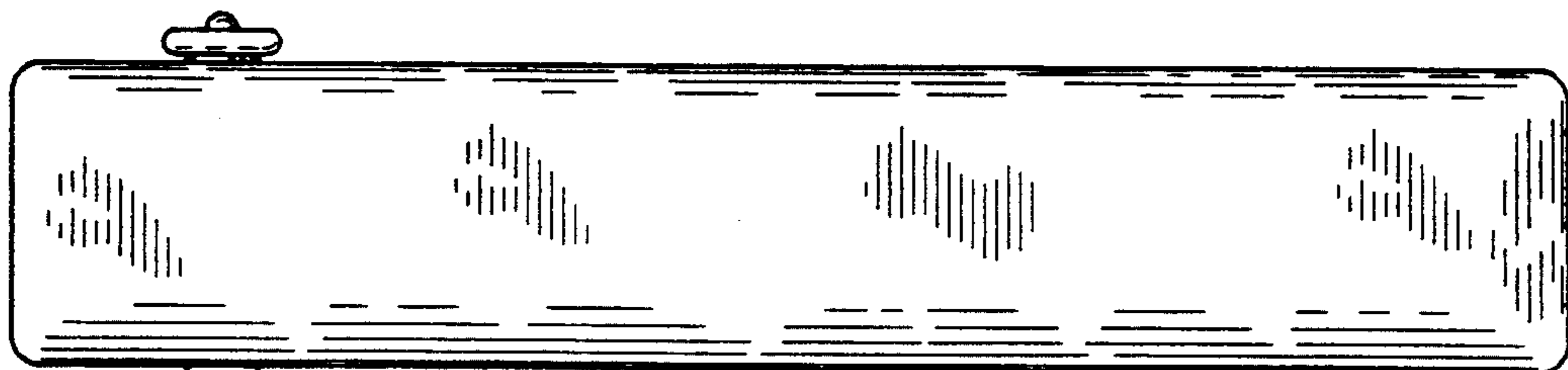

FIG. 7

