



US00D343204S

United States Patent [19]

Schramer et al.

[11] Patent Number: **Des. 343,204**

[45] Date of Patent: **** Jan. 11, 1994**

[54] **PORTABLE GAME TABLE**

[76] Inventors: **Jeffrey P. Schramer; Erik L. Anderson**, both of 1113 England St., Huntington Beach, Calif. 92648

[**] Term: **14 Years**

[21] Appl. No.: **669,229**

[22] Filed: **Mar. 14, 1991**

[52] U.S. Cl. **D21/24; D21/16**

[58] Field of Search 273/236-285; D6/406; D7/550, 553; D21/14-36

D. 319,358 8/1991 Guigiaro D6/406
3,018,107 1/1962 Erickson 273/237
4,065,125 12/1977 Chan D21/17

Primary Examiner—Bernard Ansher
Assistant Examiner—Sandra Morris
Attorney, Agent, or Firm—S. Michael Bender

[57] **CLAIM**

The ornamental design for a portable game table, as shown and described.

DESCRIPTION

FIG. 1 is a front elevational view of the portable game table showing my new design;
FIG. 2 is a rear elevational view thereof;
FIG. 3 is a left side elevational view thereof;
FIG. 4 is a right side elevational view thereof;
FIG. 5 is a top plan view thereof;
FIG. 6 is a bottom plan view thereof; and,
FIG. 7 is a perspective view thereof.

[56] **References Cited**

U.S. PATENT DOCUMENTS

D. 27,788	10/1897	Haskell	273/284
D. 34,329	4/1901	Beistel	D21/17
175,495	3/1876	Pottin	273/284
D. 193,244	7/1962	Bliss	D6/406
D. 289,247	4/1987	Wang	D6/406

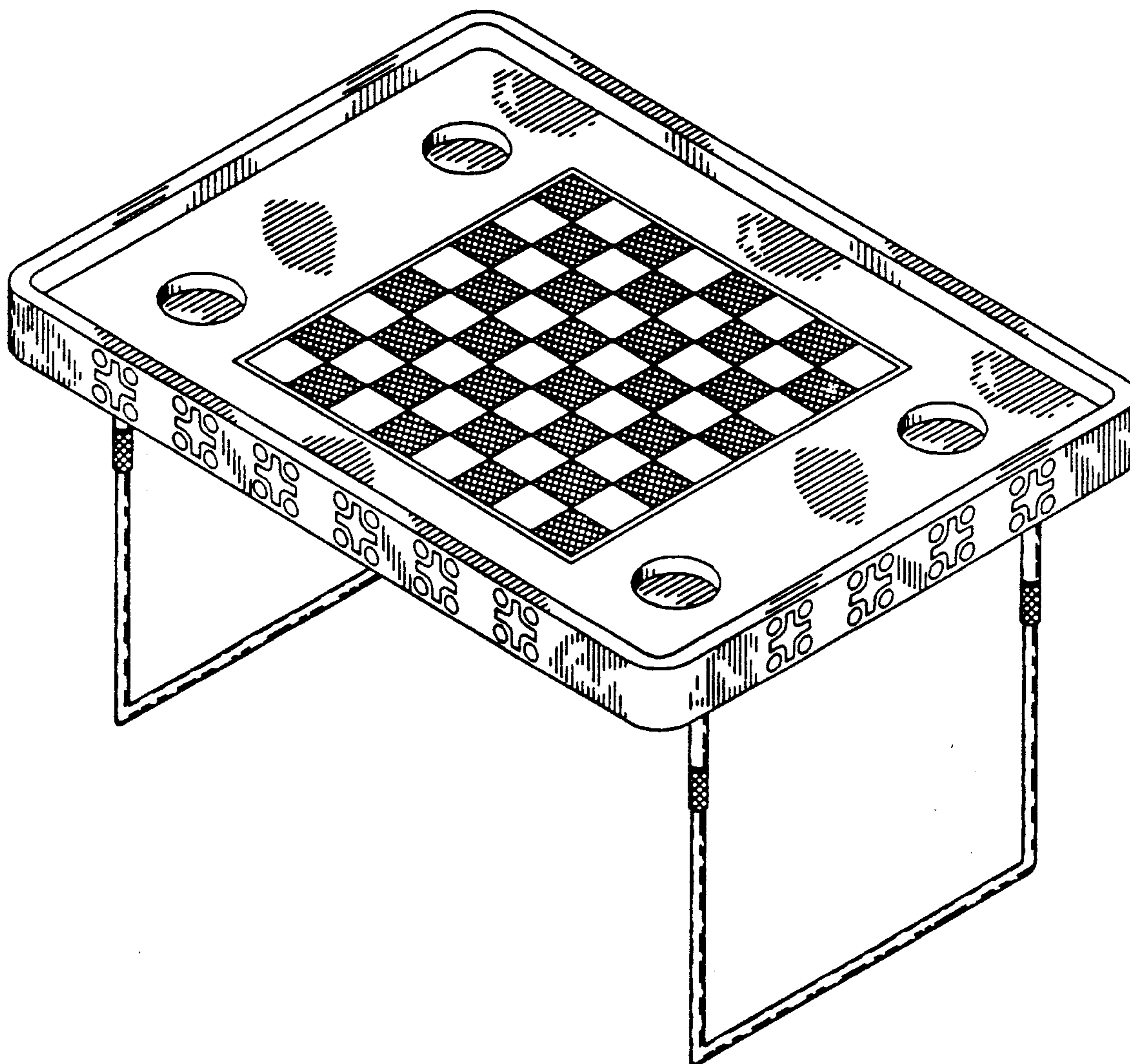

FIG. 1

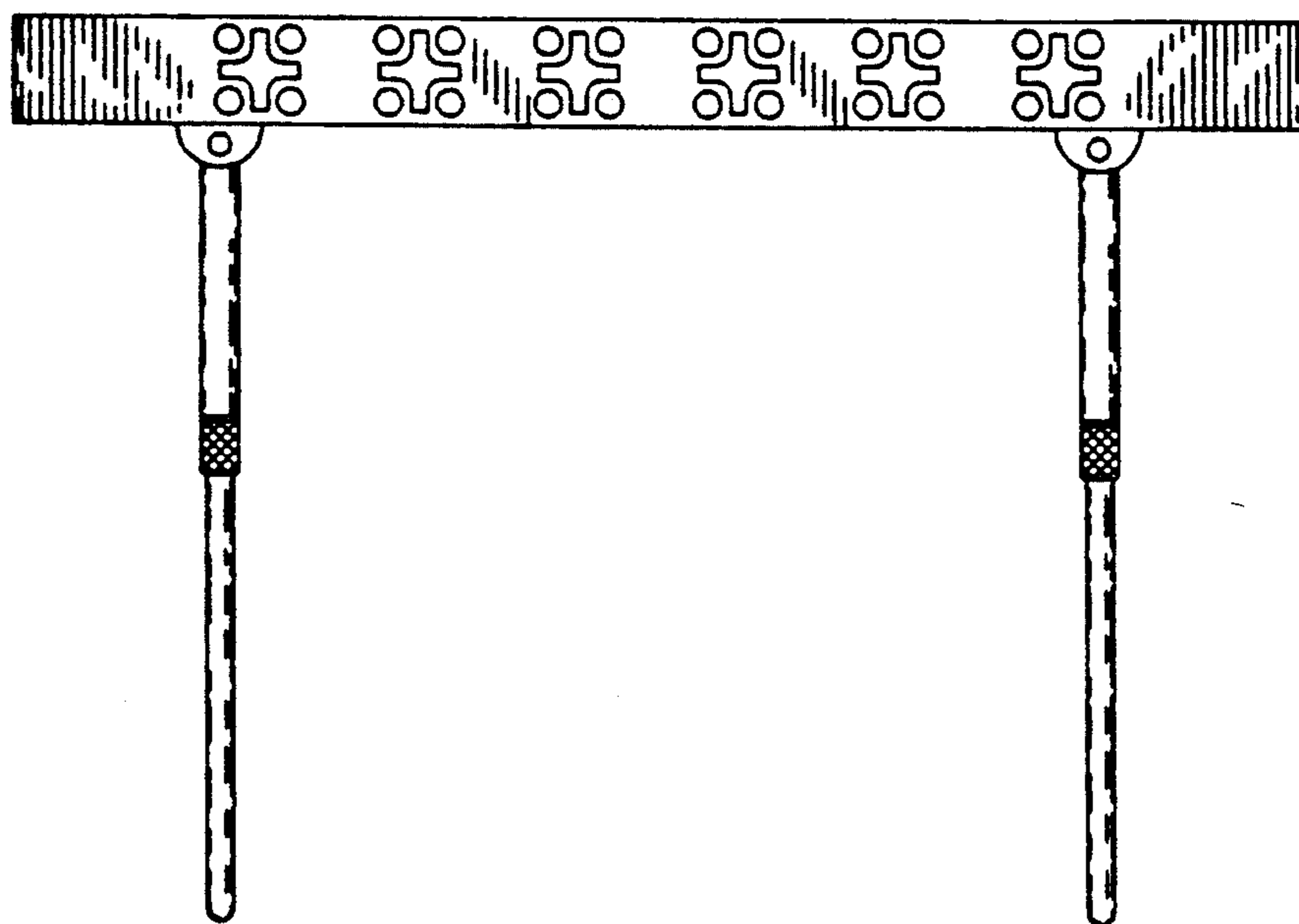

FIG. 2

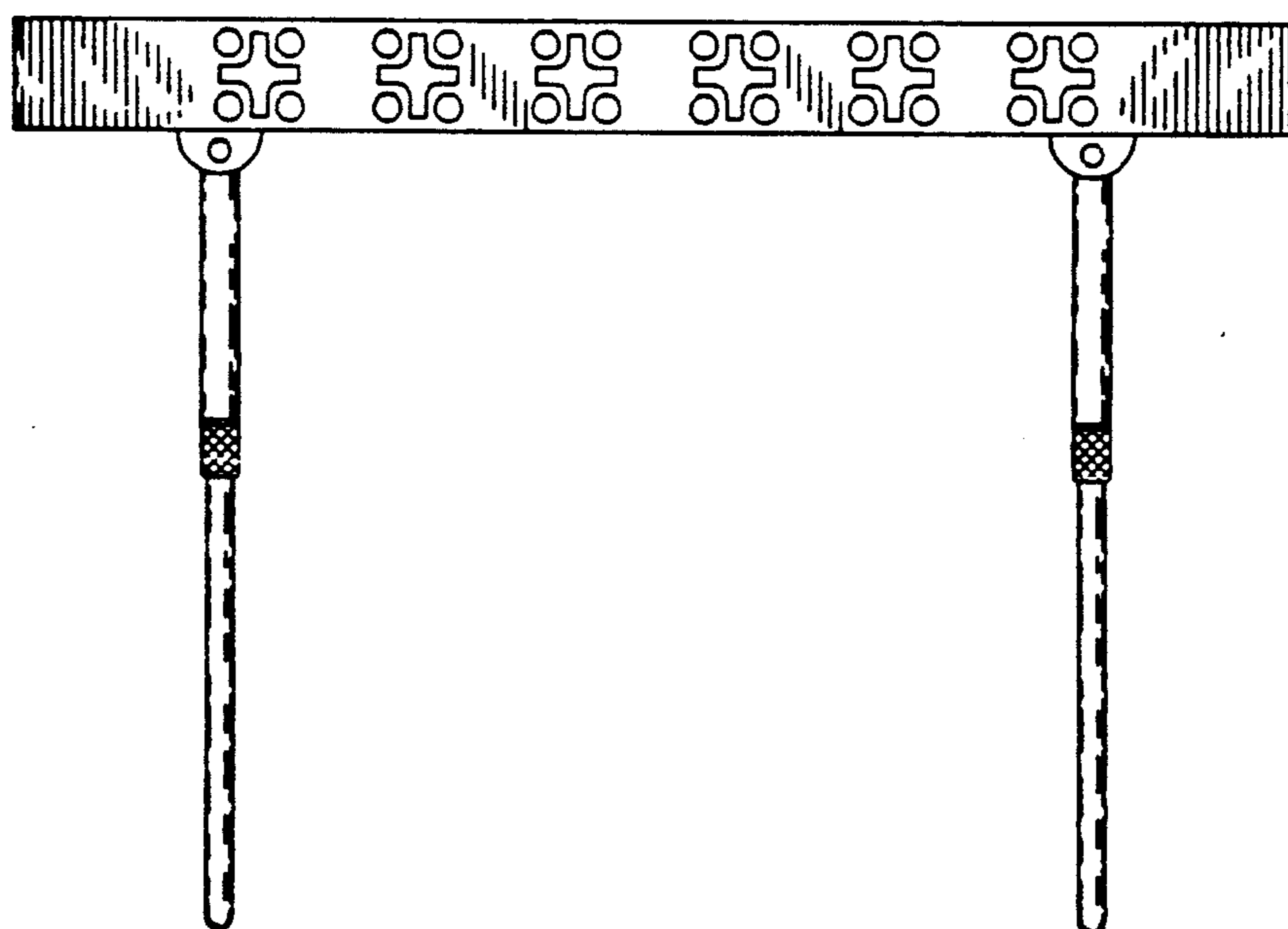

FIG. 3

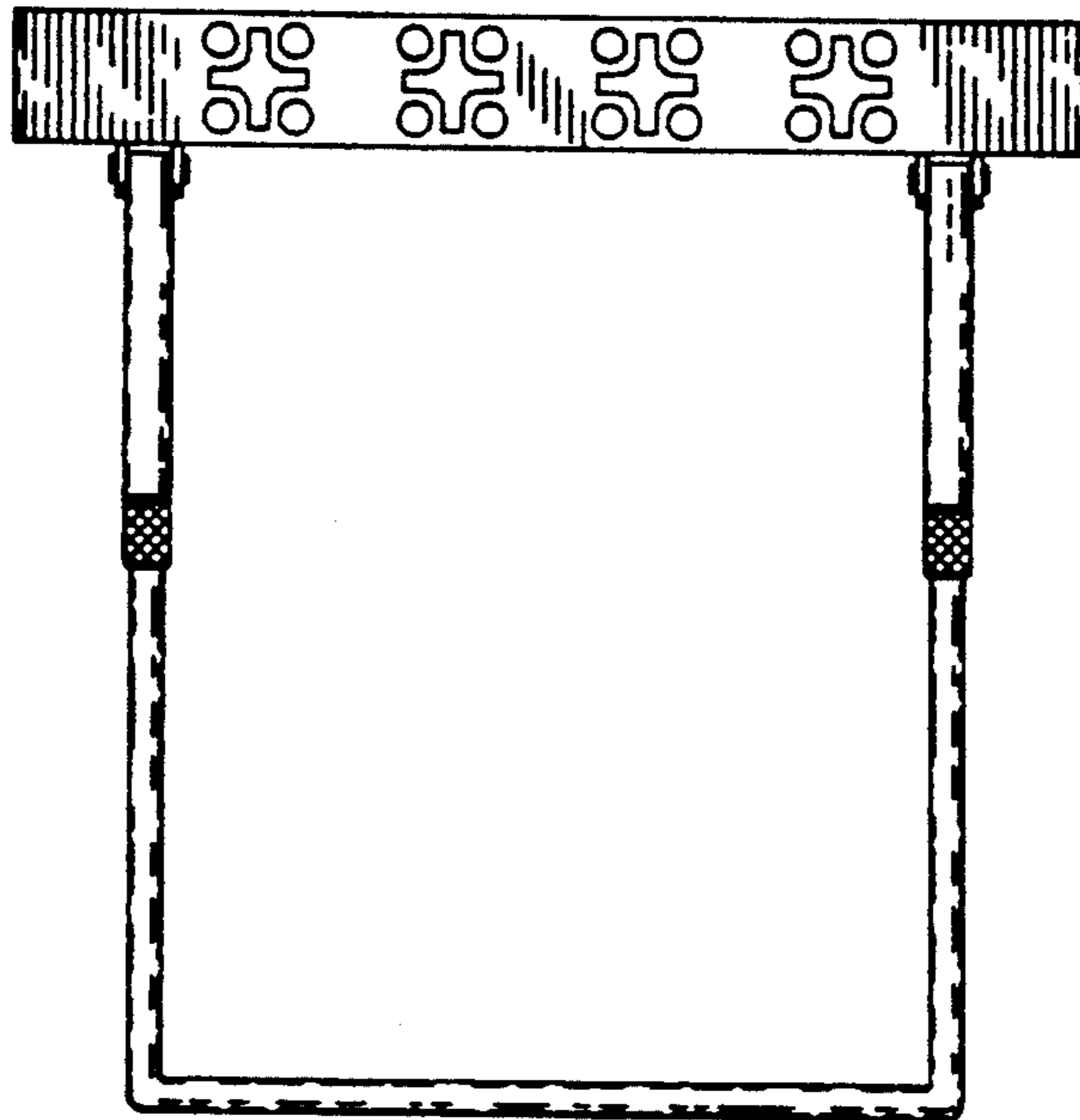

FIG. 4

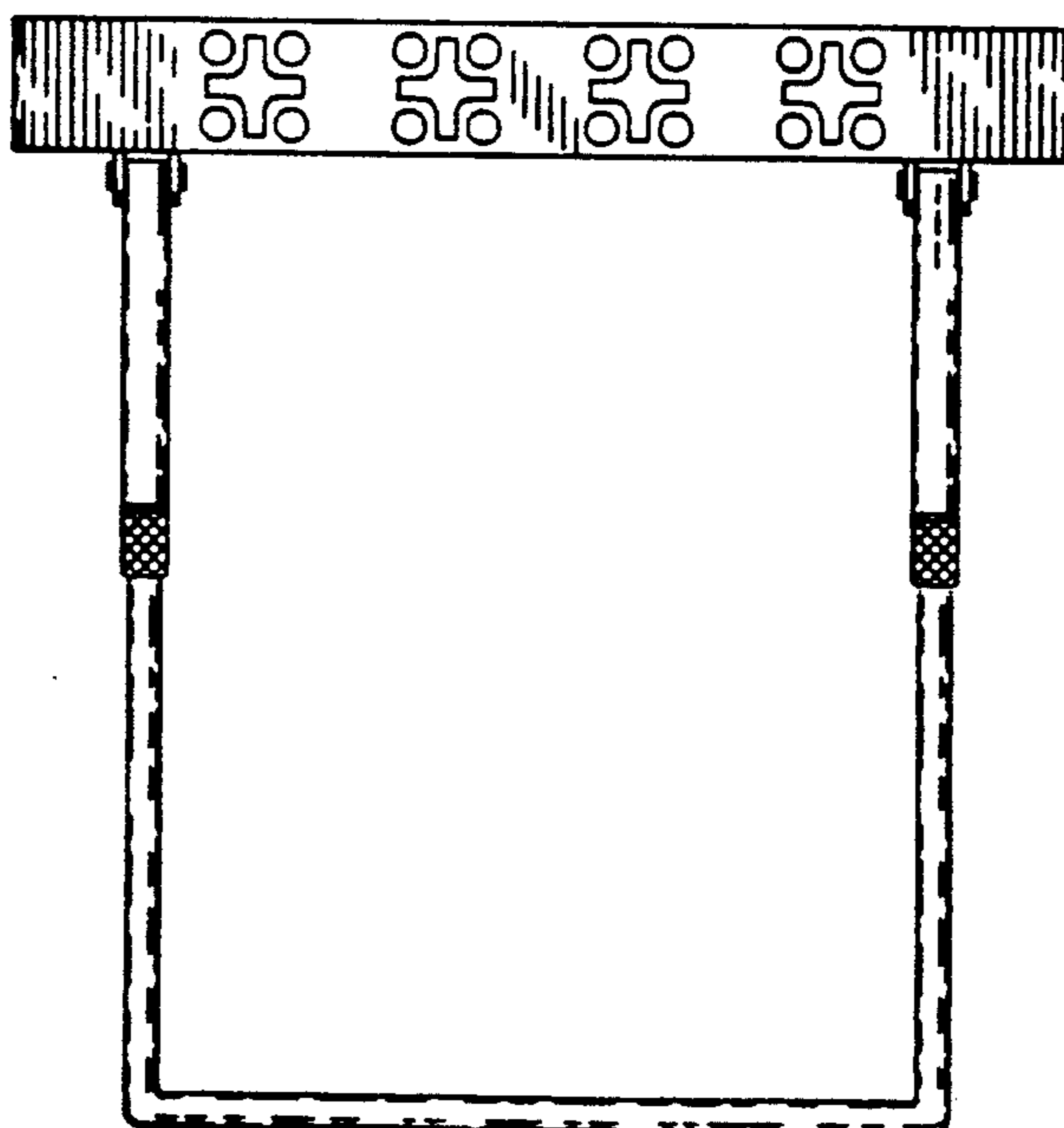

FIG. 5

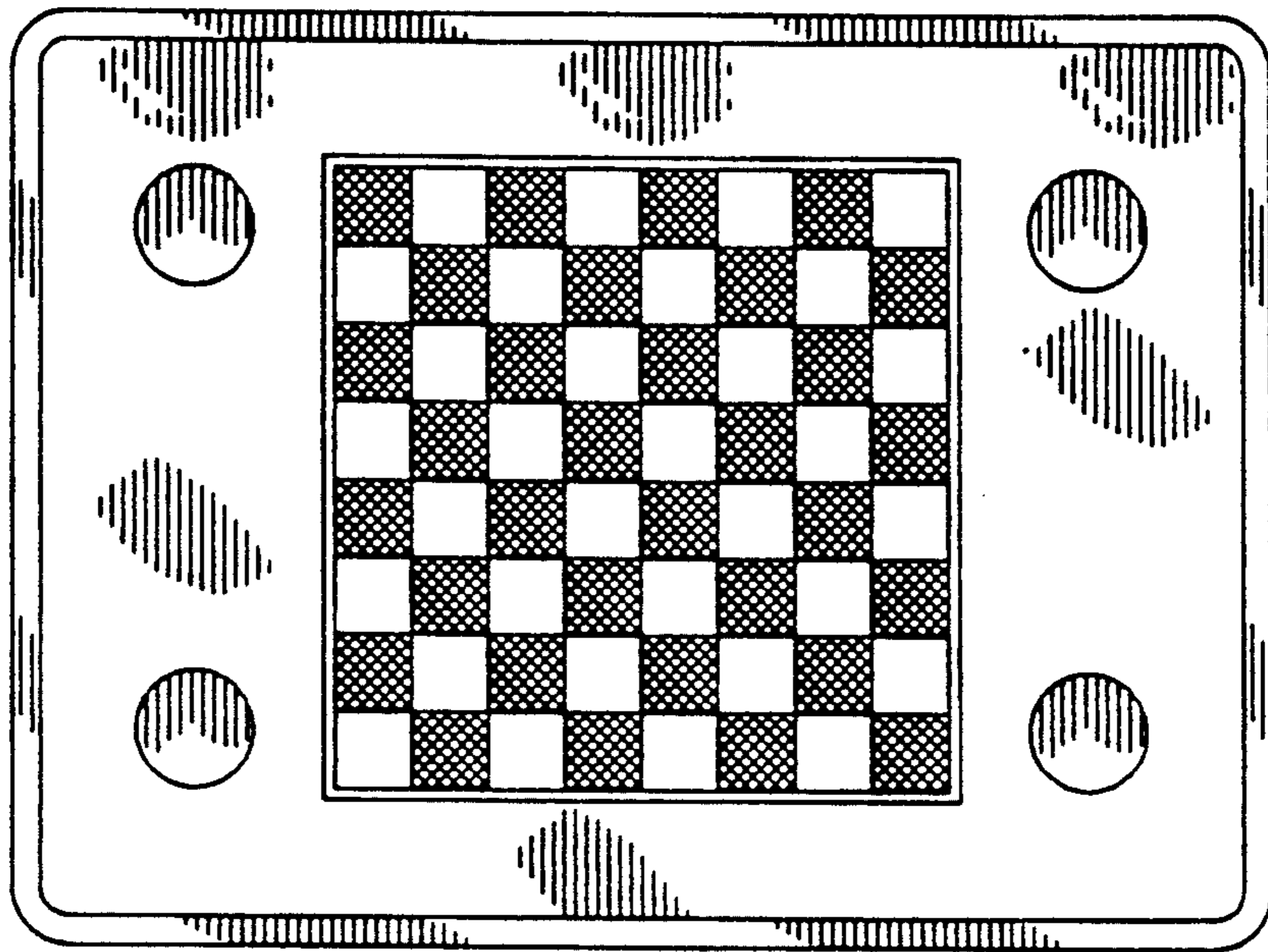

FIG. 6

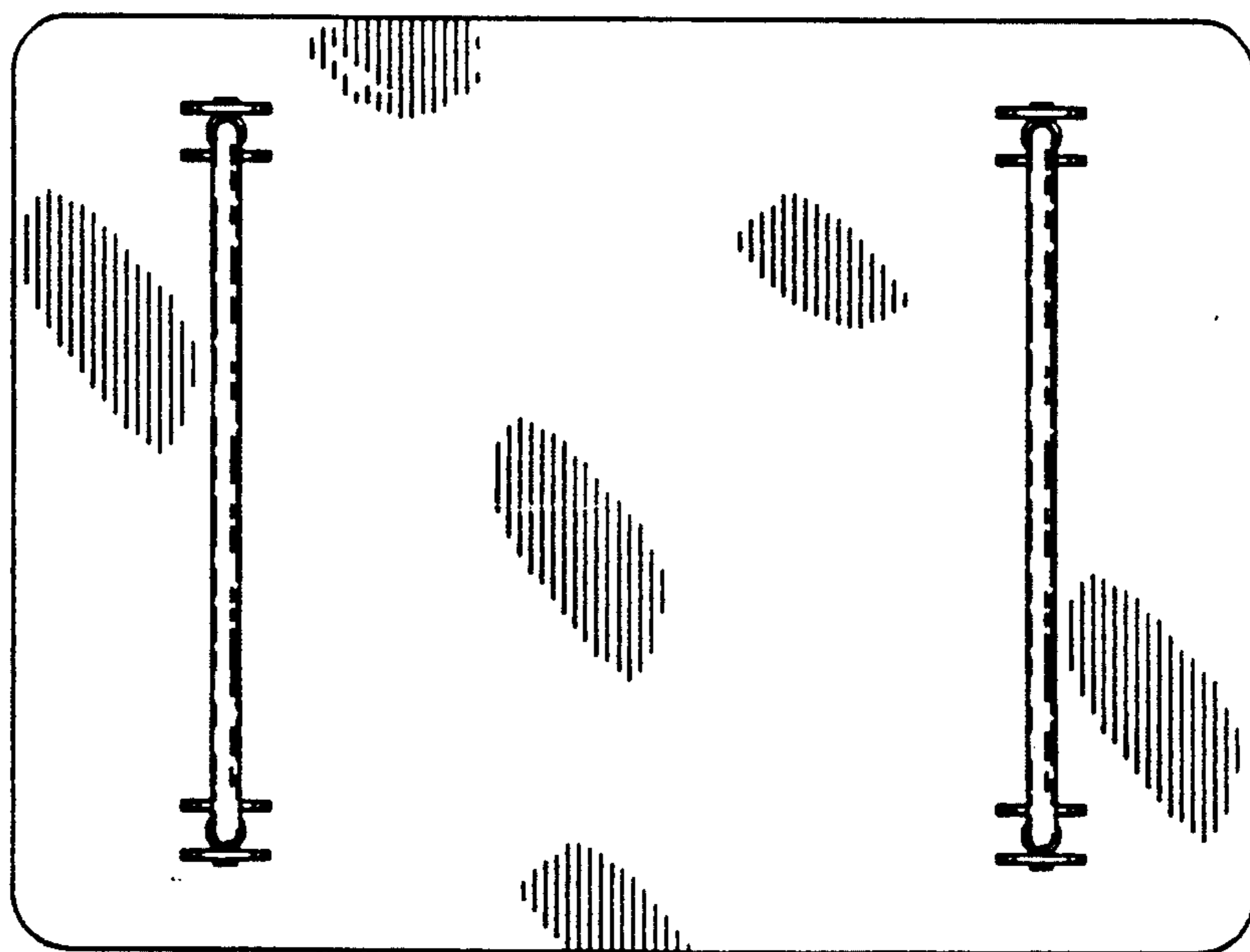

FIG. 7

