



US00D343164S

# United States Patent [19]

Miyazawa

[11] Patent Number: Des. 343,164

[45] Date of Patent: \*\* Jan. 11, 1994

[54] **RETRIEVAL SPEED CONTROLLER FOR MICROFILM ELECTRIC ROLL CARRIER**

4,314,309 2/1982 Read ..... 200/302.1 X

[75] Inventor: Yoshihiro Miyazawa, Tokyo, Japan

[73] Assignee: Canon Kabushiki Kaisha, Tokyo, Japan

[\*\*] Term: 14 Years

[21] Appl. No.: 2,675

[22] Filed: Dec. 16, 1992

[30] Foreign Application Priority Data

Jun. 19, 1992 [JP] Japan ..... 4-18236

[52] U.S. Cl. .... D13/162

[58] Field of Search ..... 388/395; 338/184, 197, 338/198, 199, 200, 232; 200/302.1; D13/162, 168; D10/49; D14/159

[56] References Cited

U.S. PATENT DOCUMENTS

- D. 210,026 1/1968 Kahn ..... D14/159
- D. 217,023 3/1970 Warner et al. .... D10/49
- D. 247,746 4/1978 Hall ..... D13/168 X
- D. 306,998 4/1990 Mintz et al. .... D13/164

OTHER PUBLICATIONS

Light control on p. 25 of *Home Furnishings Daily* May 9, 1963.

*Primary Examiner*—Wallace R. Burke

*Assistant Examiner*—J. Sincavage

*Attorney, Agent, or Firm*—Fitzpatrick, Cella, Harper & Scinto

[57] CLAIM

The ornamental design for a retrieval speed controller for microfilm electric roll carrier, as shown and described.

DESCRIPTION

FIG. 1 is a front elevational view of a retrieval speed controller for microfilm electric roll carrier showing my new design;

FIG. 2 is a rear elevational view thereof;

FIG. 3 is a top plan view thereof;

FIG. 4 is a bottom plan view thereof;

FIG. 5 is a left side elevational view thereof;

FIG. 6 is a right side elevational view thereof; and,

FIG. 7 is a perspective view thereof.

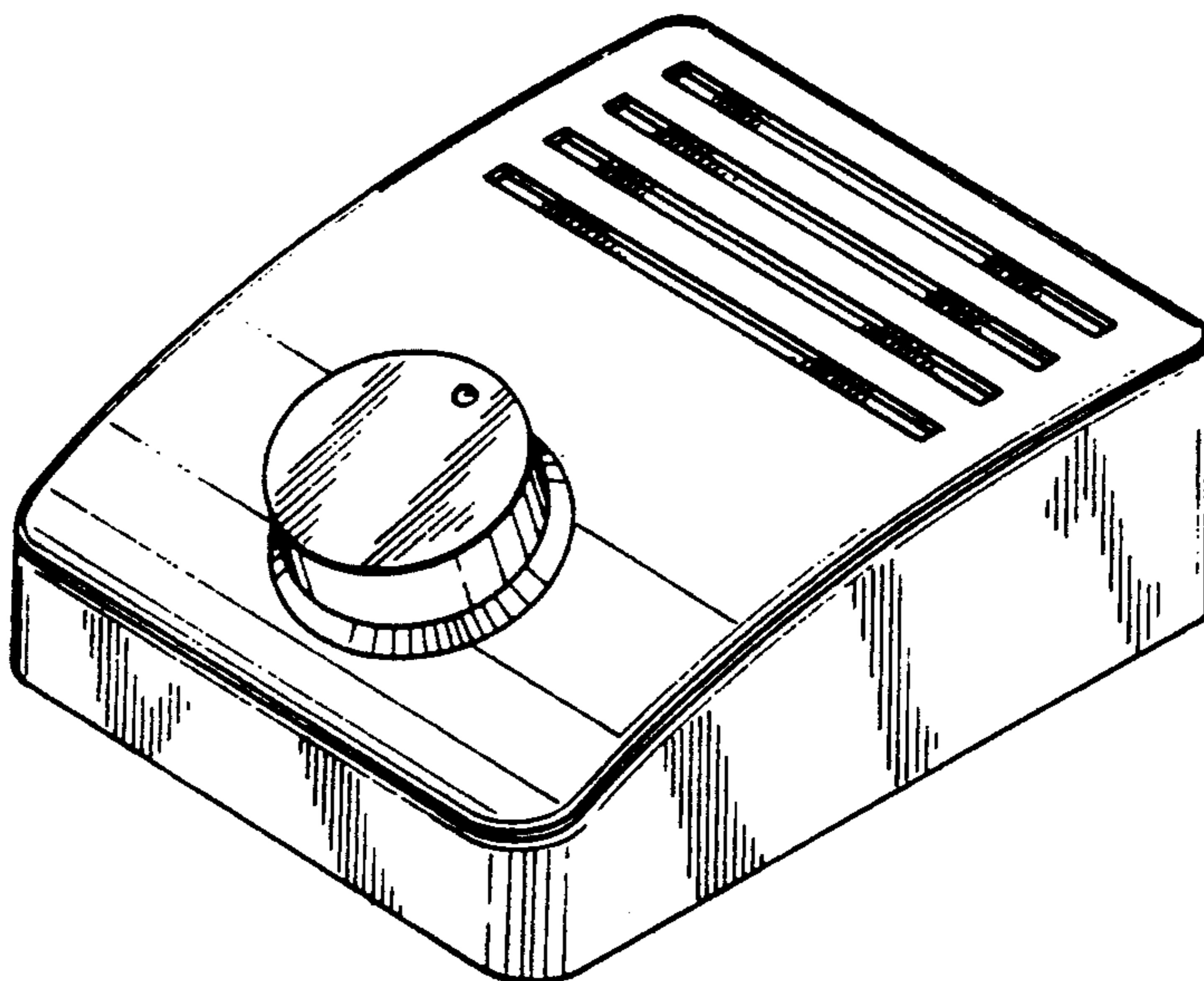

FIG. 1

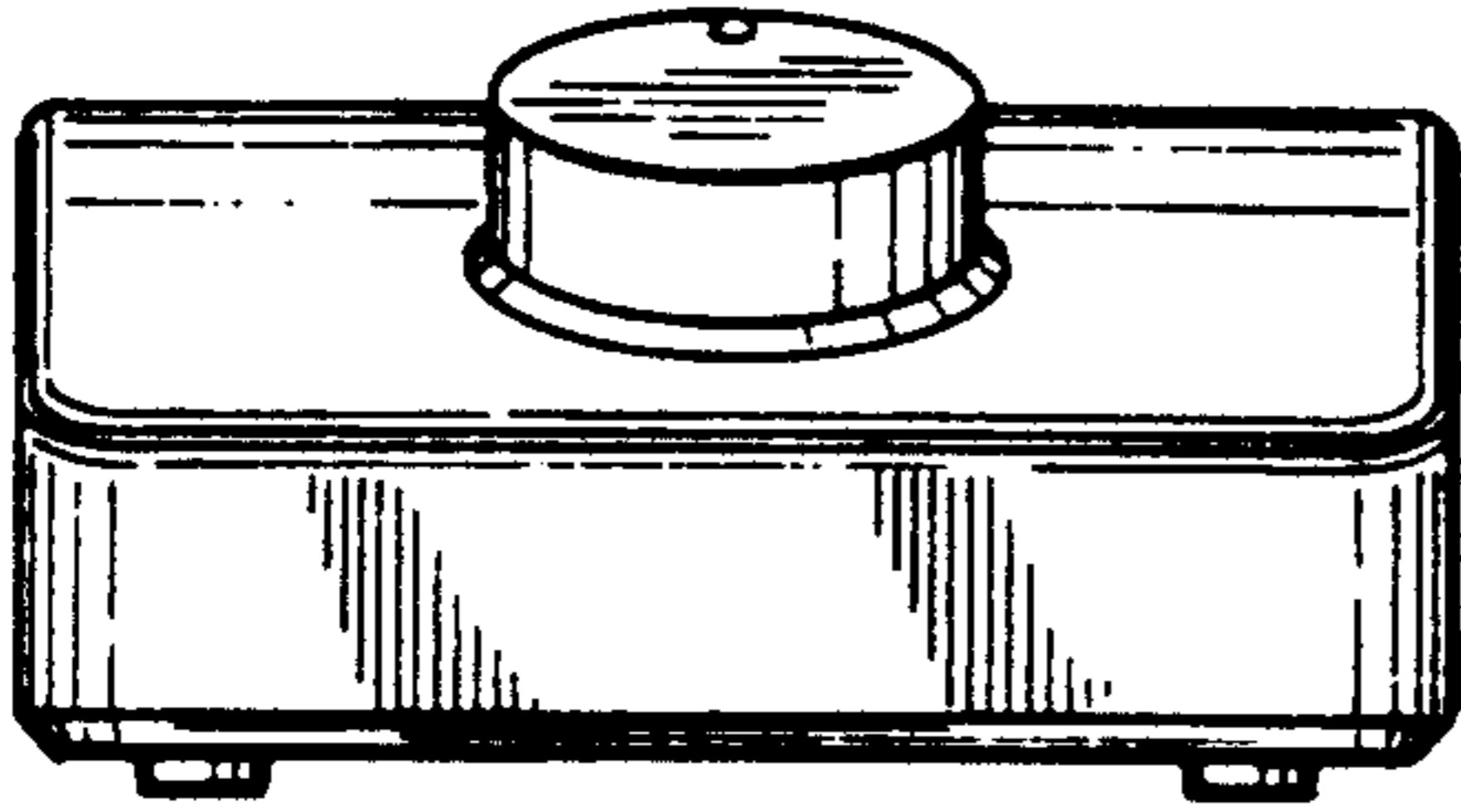

FIG. 2

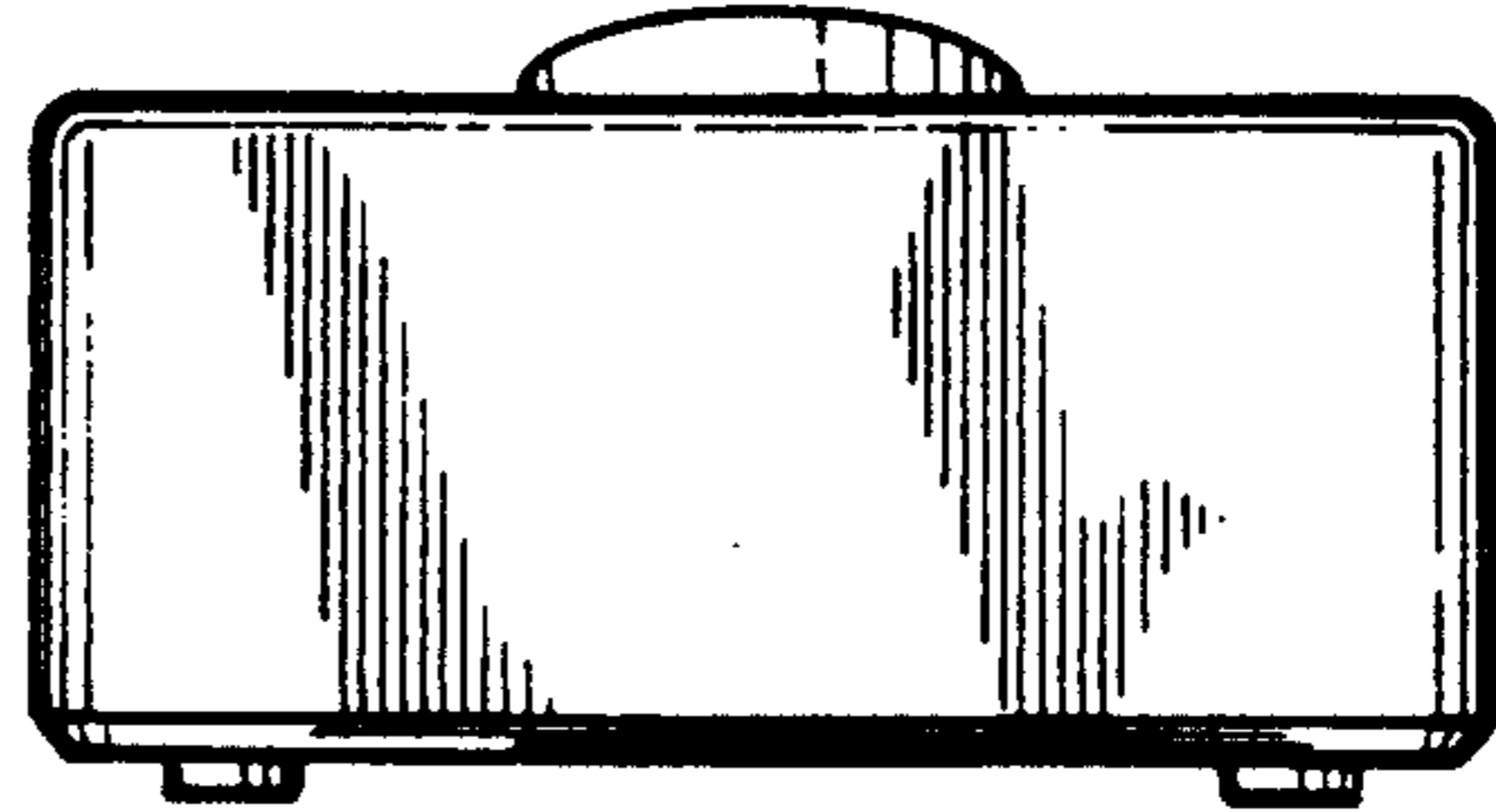

FIG. 3

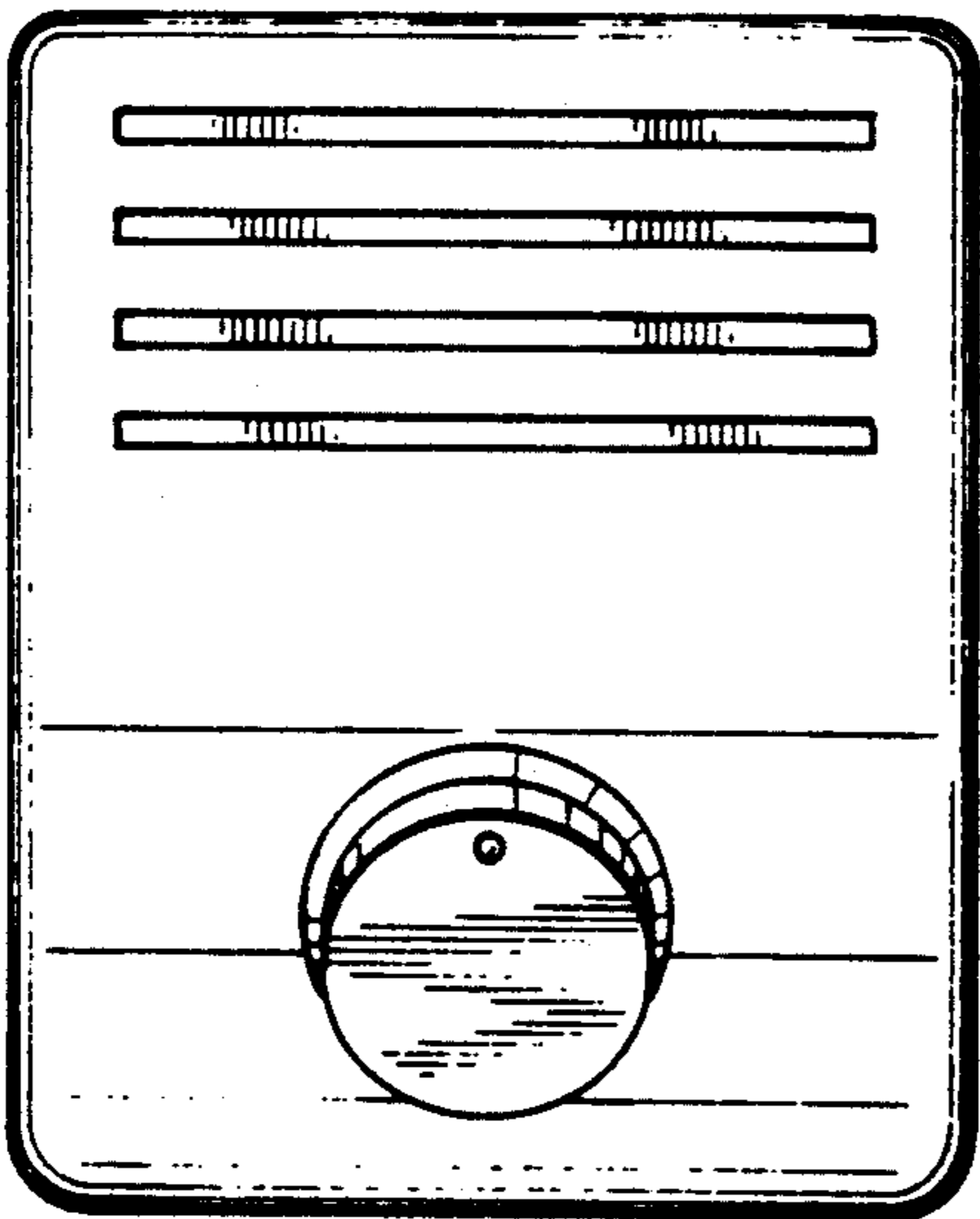

FIG. 4

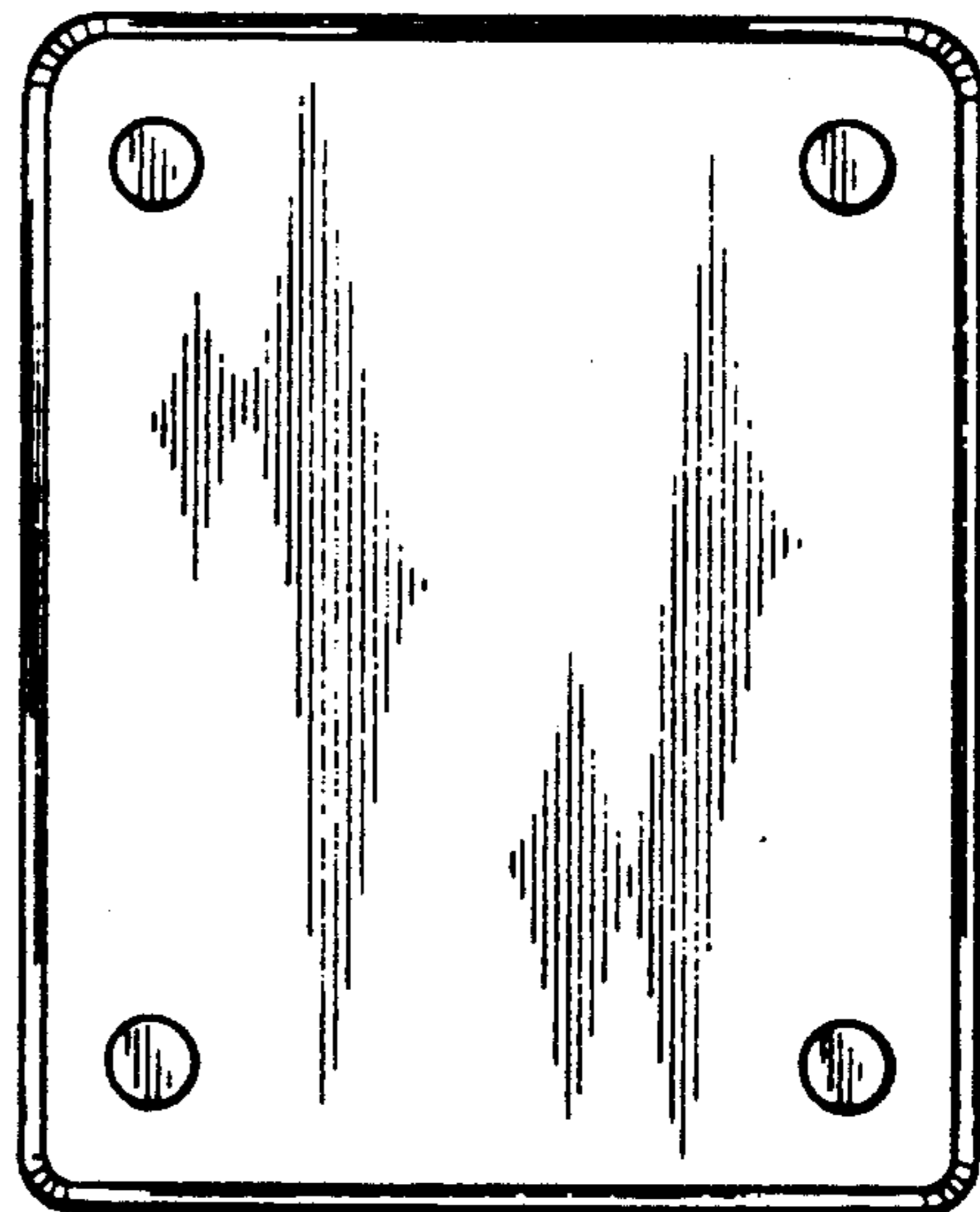

FIG. 5

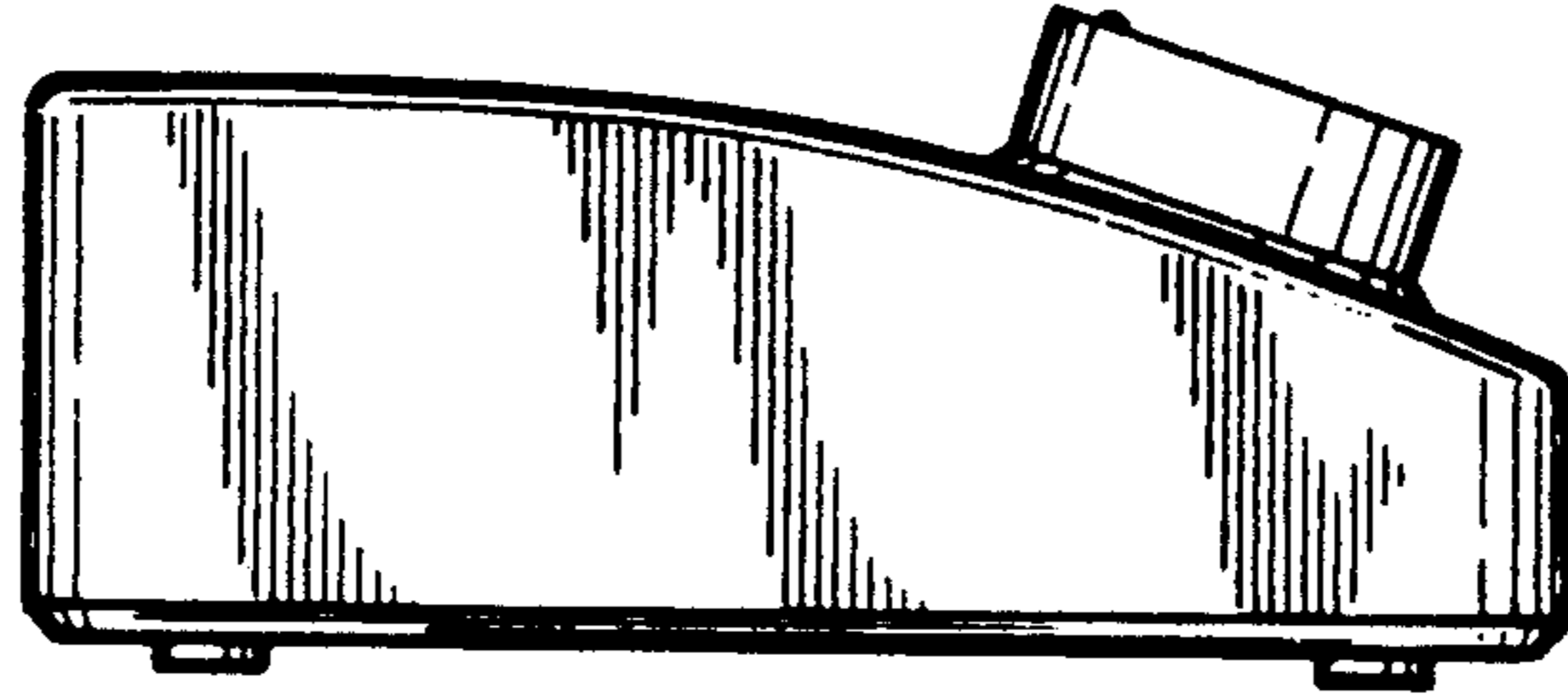

FIG. 6

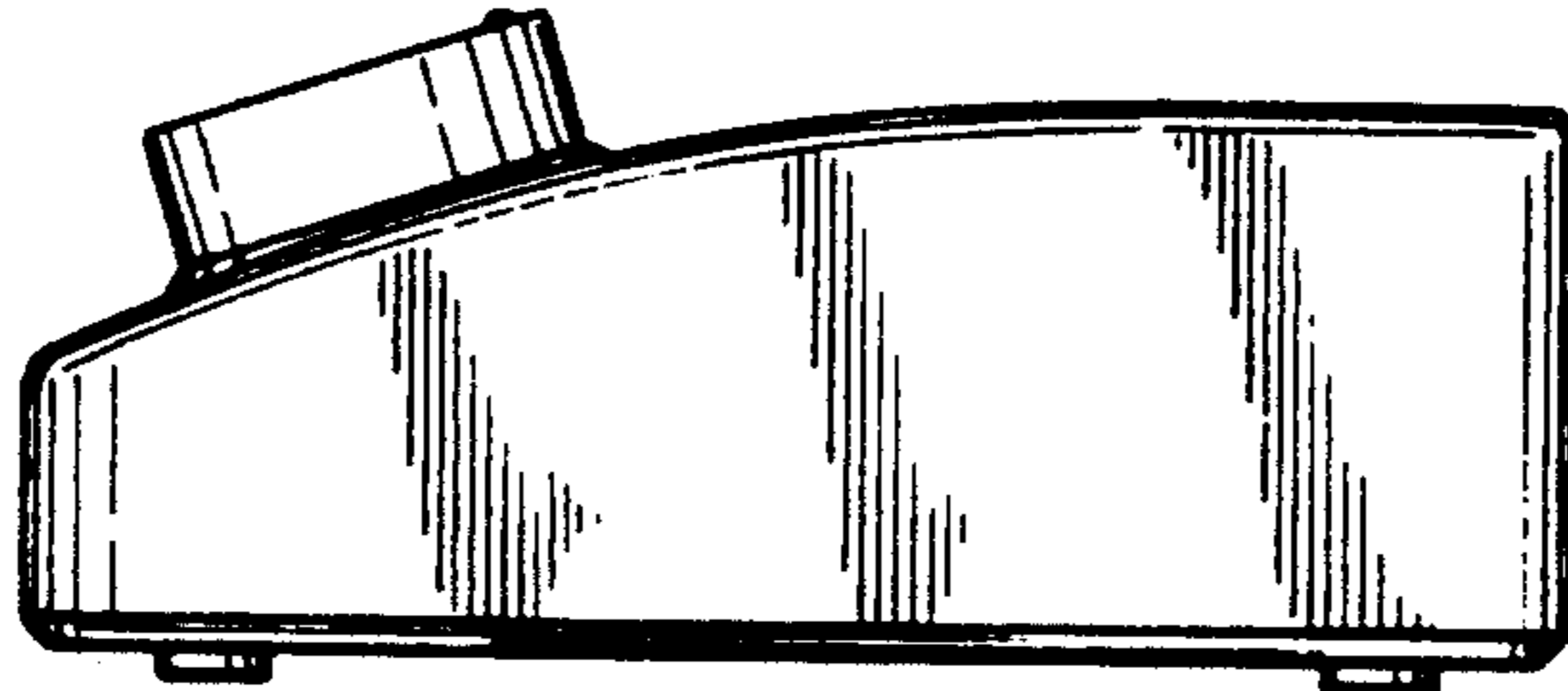

FIG. 7

