



US00D343161S

United States Patent [19] Lapointe

[11] Patent Number: **Des. 343,161**

[45] Date of Patent: **** Jan. 11, 1994**

[54] **WATERCRAFT**

[75] Inventor: **Denys Lapointe, Grant, Fla.**

[73] Assignee: **Bombardier Inc., Montreal, Canada**

[**] Term: **14 Years**

[21] Appl. No.: **933,038**

[22] Filed: **Aug. 20, 1992**

[52] U.S. Cl. **D12/307**

[58] Field of Search **114/270; D12/307, 300,
D12/314, 311**

[56] **References Cited**

U.S. PATENT DOCUMENTS

D. 307,414 4/1990 Lapointe D12/307

D. 325,556 4/1992 Lapointe D12/307

Primary Examiner—**Kay H. Chin**

Attorney, Agent, or Firm—**St. Onge Steward Johnston & Reens**

[57] **CLAIM**

The ornamental design for a watercraft, as shown and described.

DESCRIPTION

FIG. 1 is a side elevational view of a watercraft, showing my new design;

FIG. 2 is a rear end elevational view;

FIG. 3 is a front end elevational view;

FIG. 4 is a bottom plan view; and,

FIG. 5 is a top plan view.

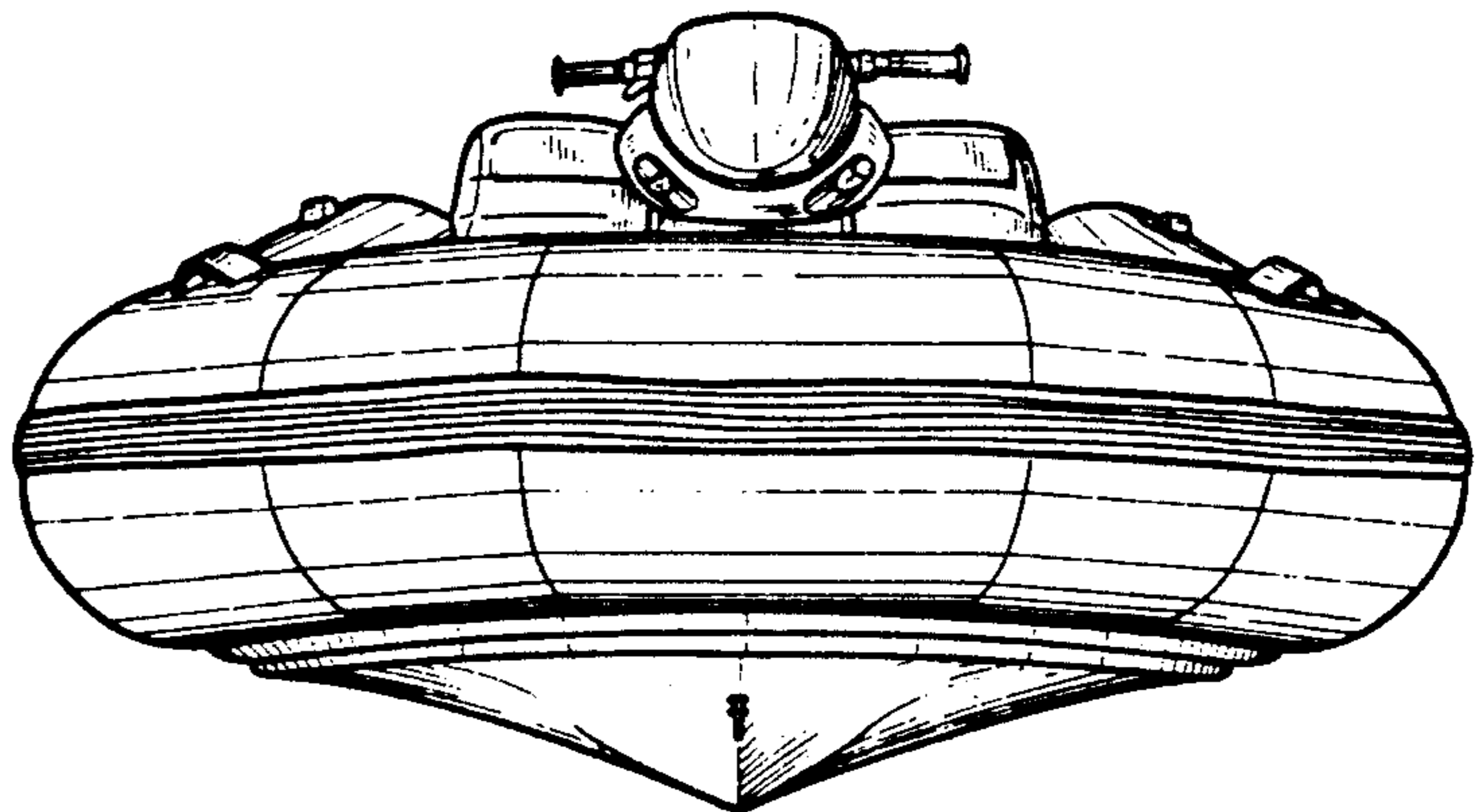
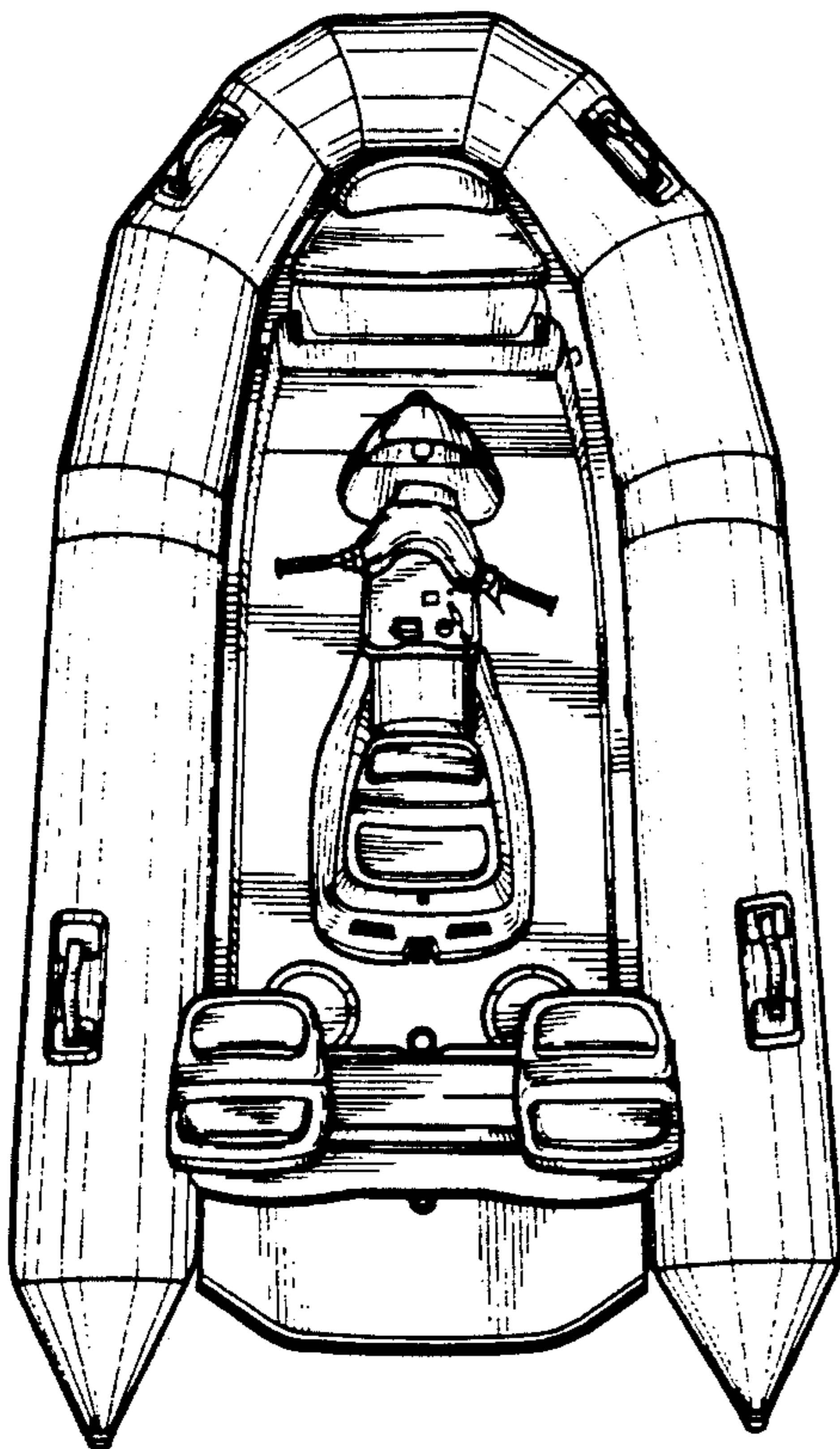

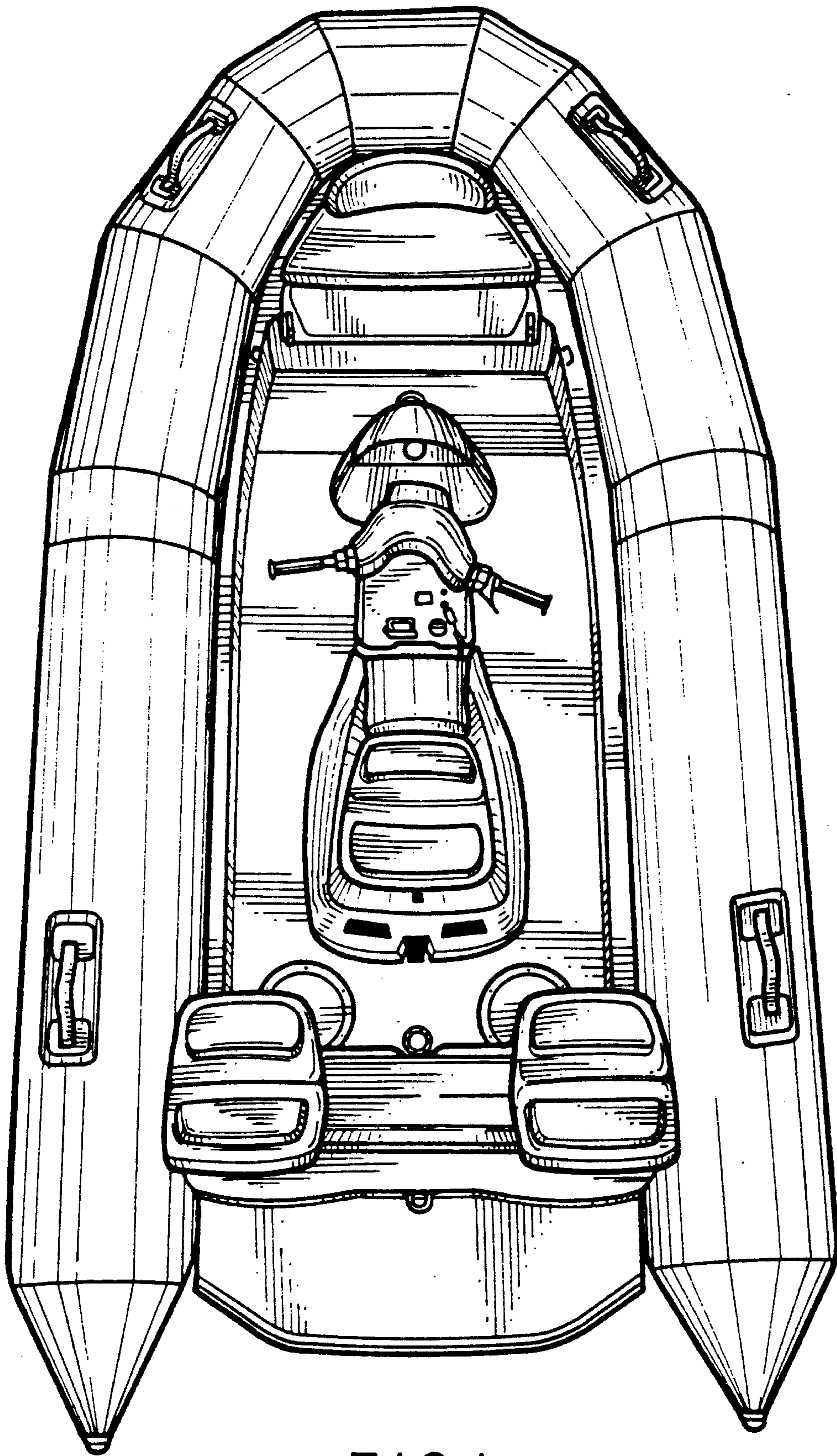

FIG. 1

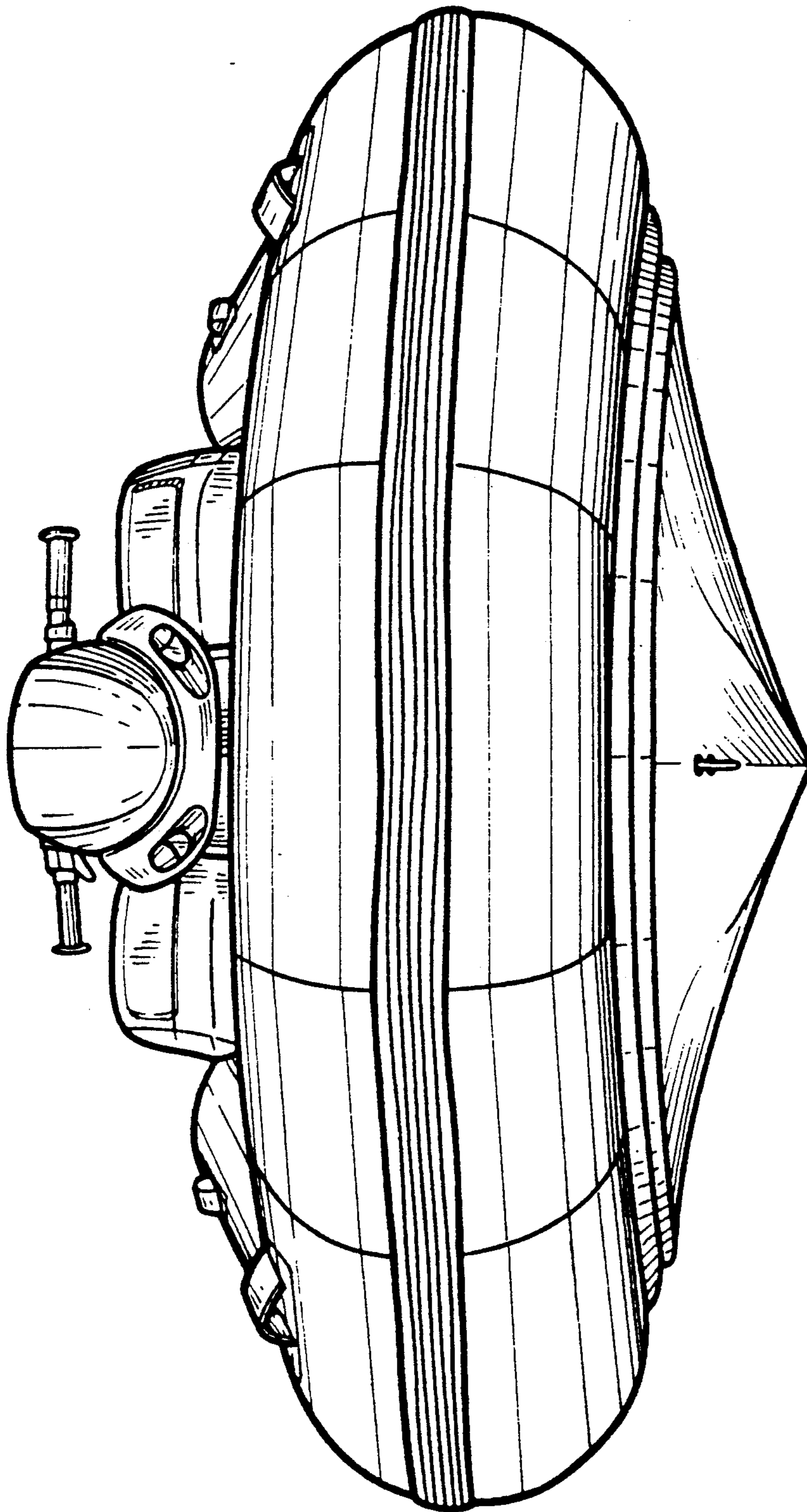

FIG. 2

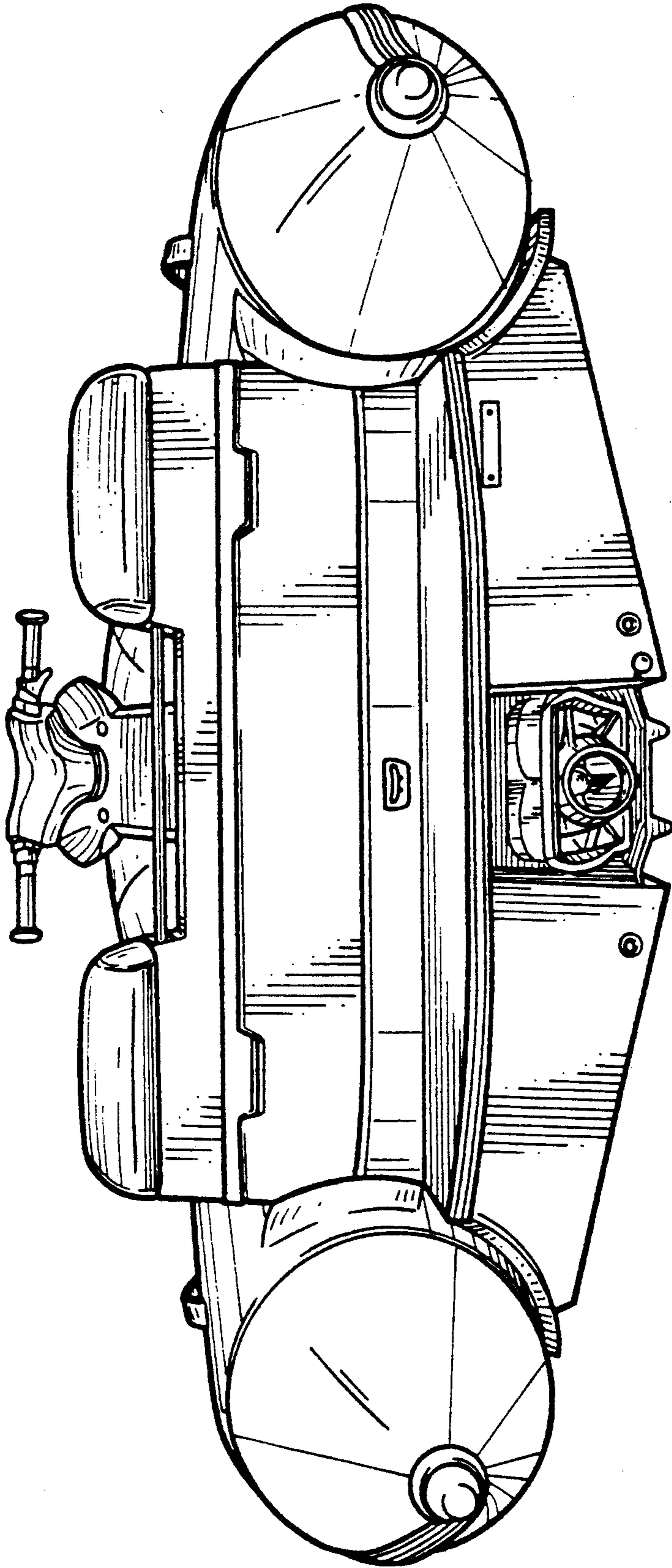

FIG. 3

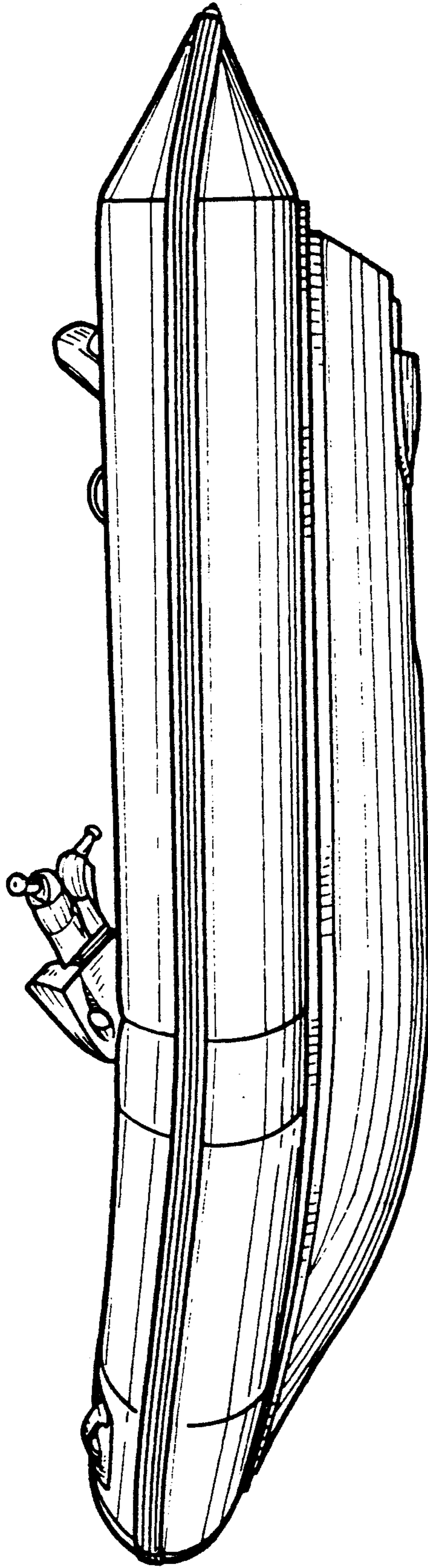

FIG. 4

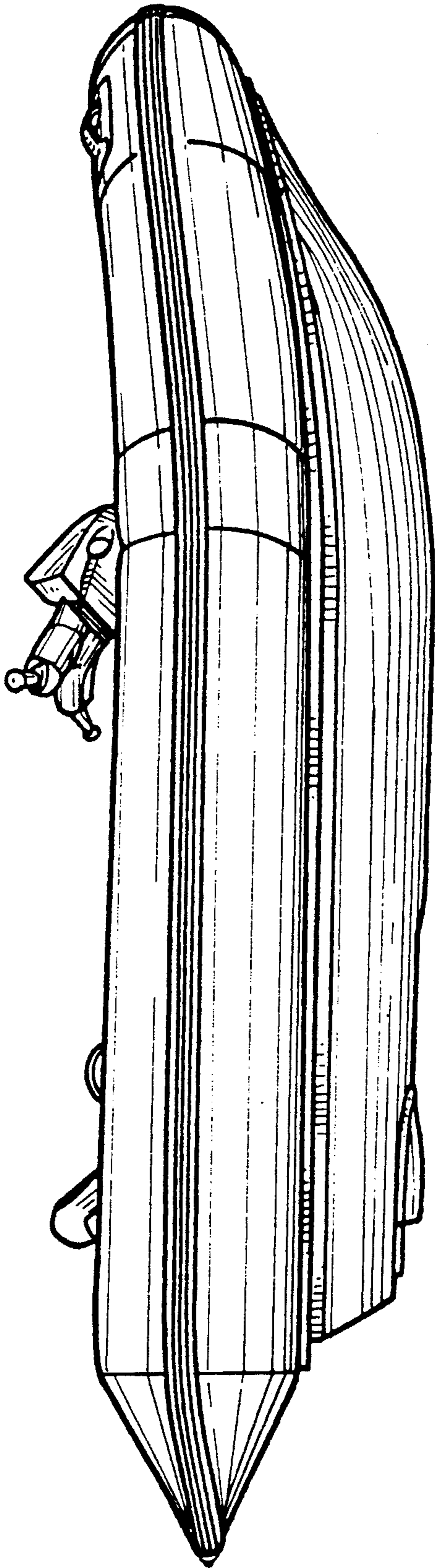

FIG. 5