



US00D343160S

# United States Patent [19]

[11] Patent Number: **Des. 343,160**

**LaPointe**

[45] Date of Patent: **\*\* Jan. 11, 1994**

[54] **EXPLORER BOAT**

[75] Inventor: **Denys LaPointe**, Grant, Fla.

[73] Assignee: **Bombardier Inc.**, Montreal, Canada

[\*\*] Term: **14 Years**

[21] Appl. No.: **930,905**

[22] Filed: **Aug. 17, 1992**

[52] U.S. Cl. .... **D12/307; D12/316**

[58] Field of Search ..... **114/363, 270, 345; D12/307, 300, 316**

[56] **References Cited**

**U.S. PATENT DOCUMENTS**

D. 309,128 7/1990 Walker et al. .... D12/307  
5,131,348 7/1992 Roy ..... 114/363

*Primary Examiner*—Kay H. Chin

*Attorney, Agent, or Firm*—St. Onge Steward Johnston & Reens

[57] **CLAIM**

The ornamental design for an explorer boat, as shown and described.

**DESCRIPTION**

FIG. 1 is a top plan view of an explorer boat, showing my new design;

FIG. 2 is a front end elevational view;

FIG. 3 is a rear end elevational view;

FIG. 4 is a side elevational view;

FIG. 5 is an elevational view, showing the side not shown in FIG. 4; and,

FIG. 6 is a bottom plan view.

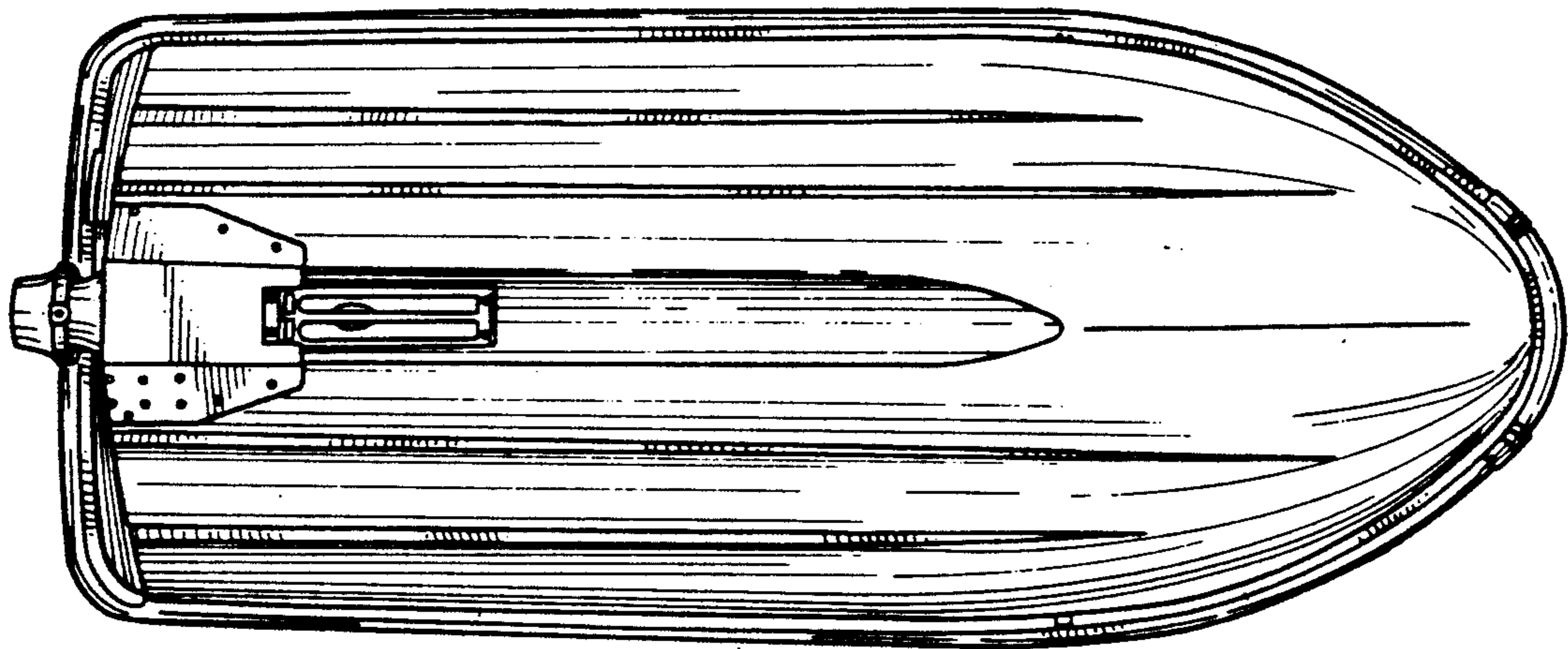
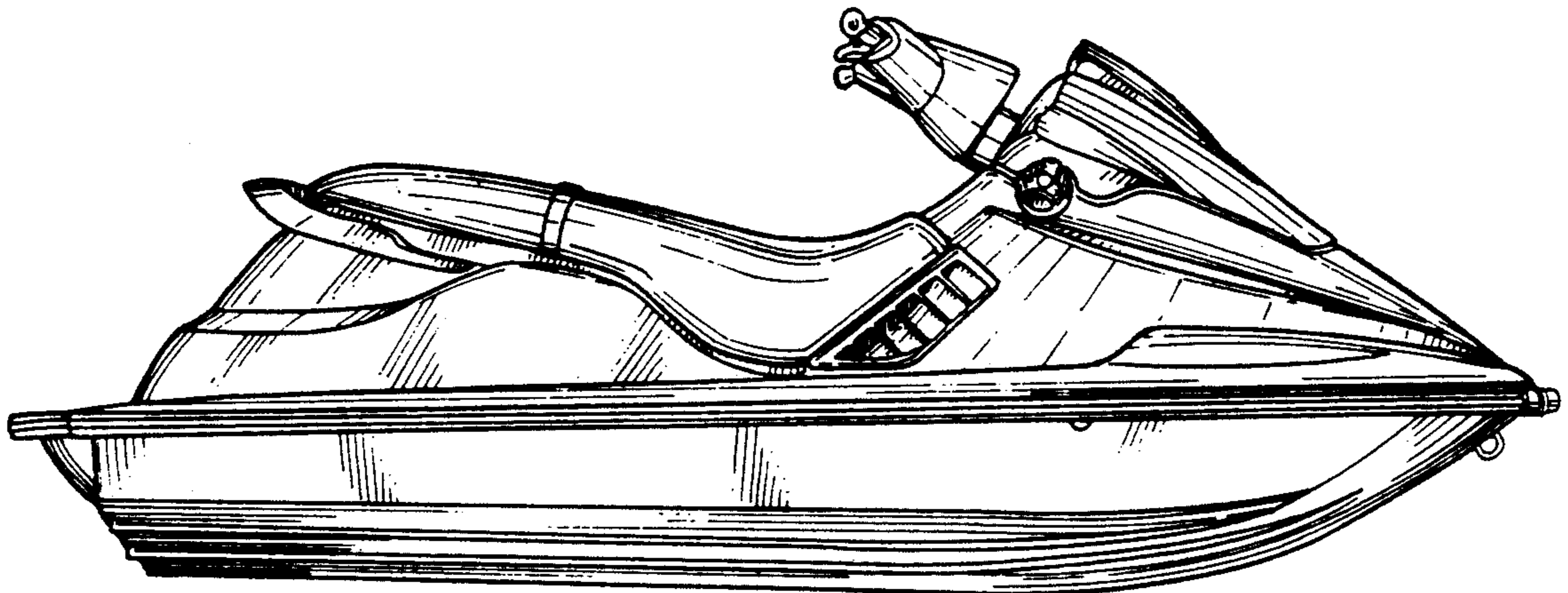

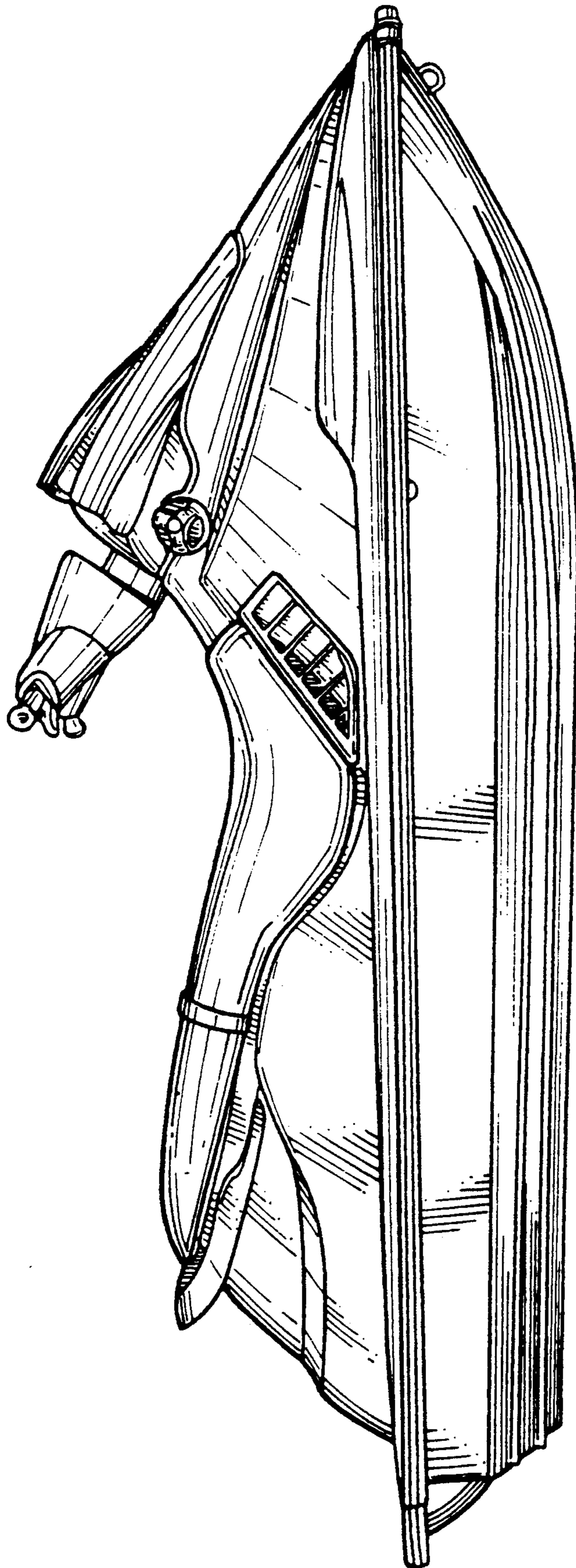

FIG. 1

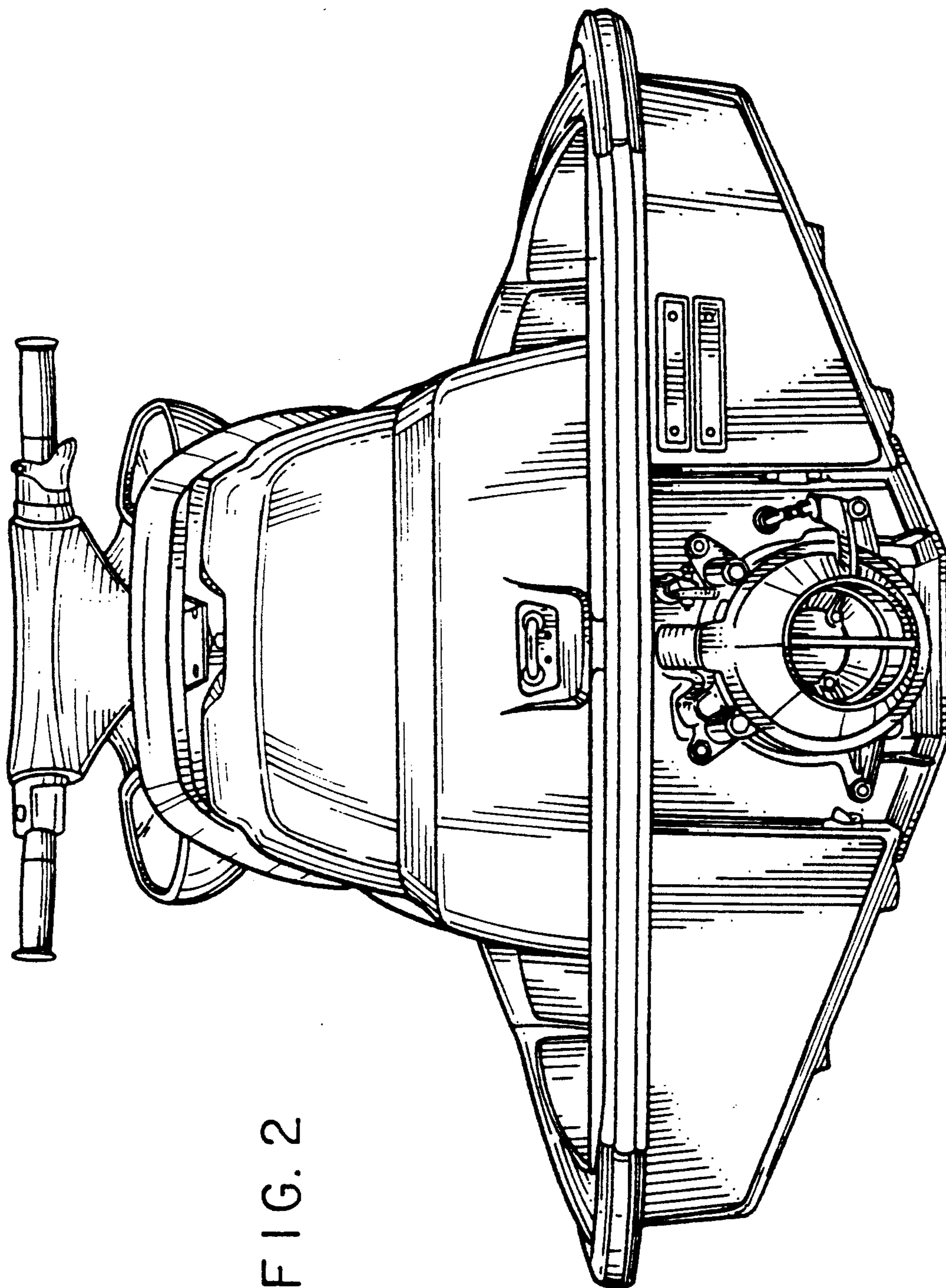

FIG. 2

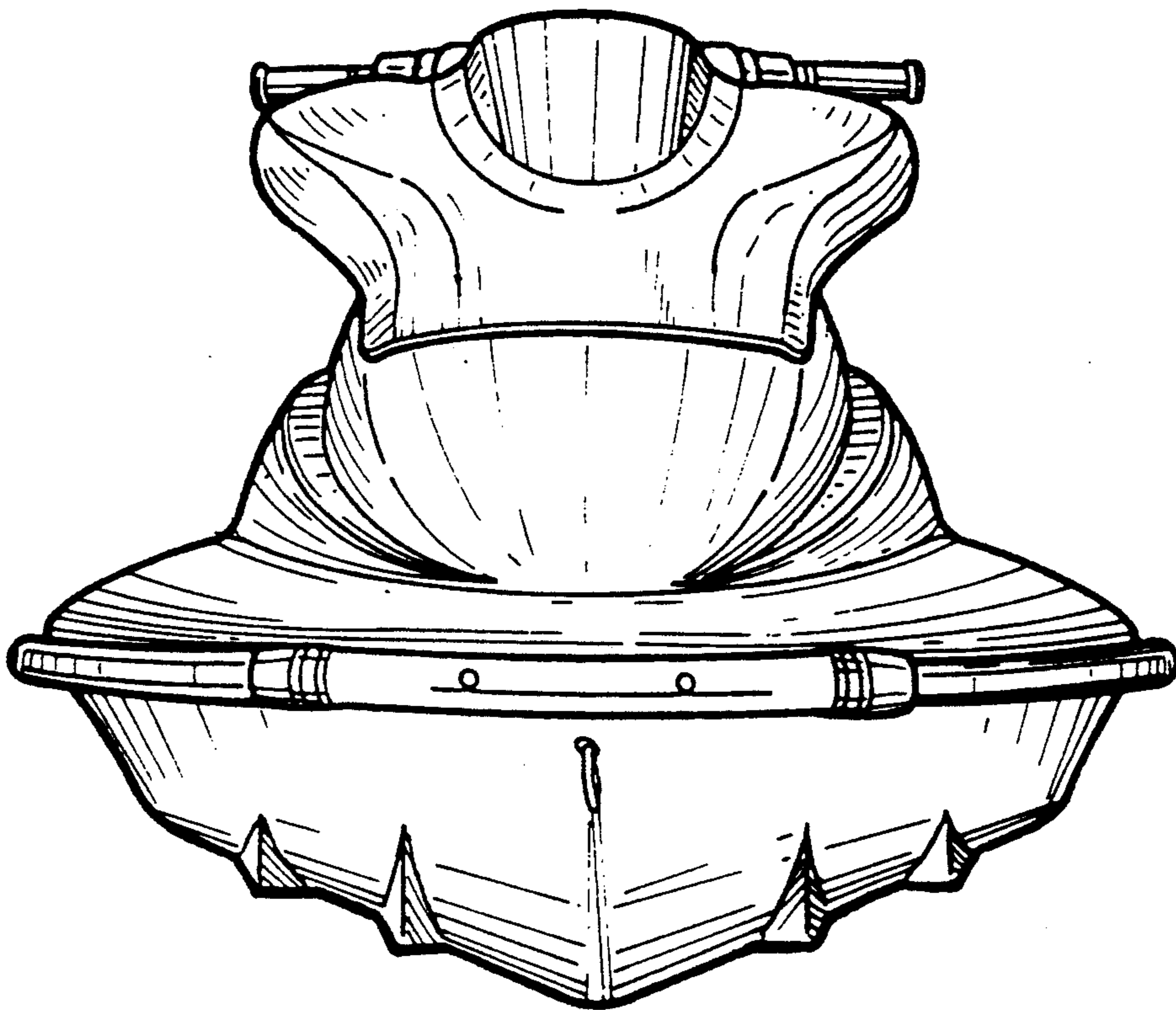

FIG. 3

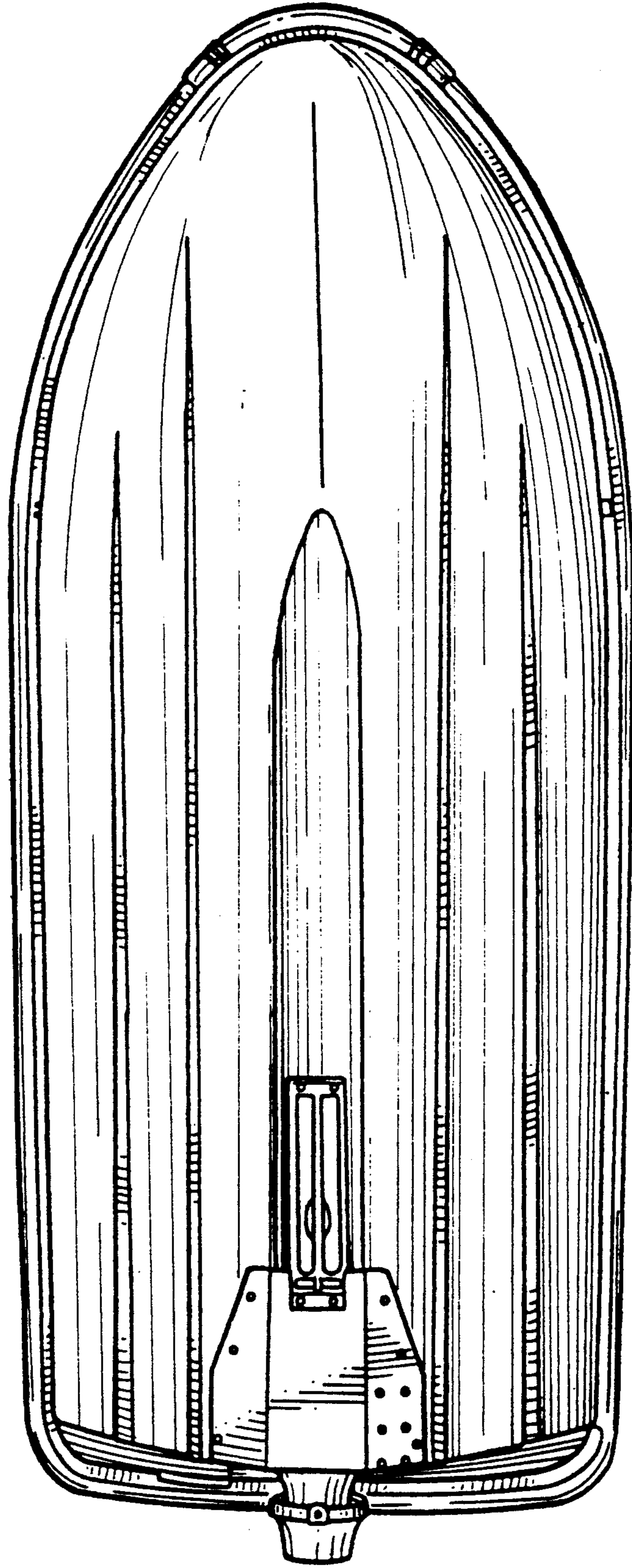

FIG. 4

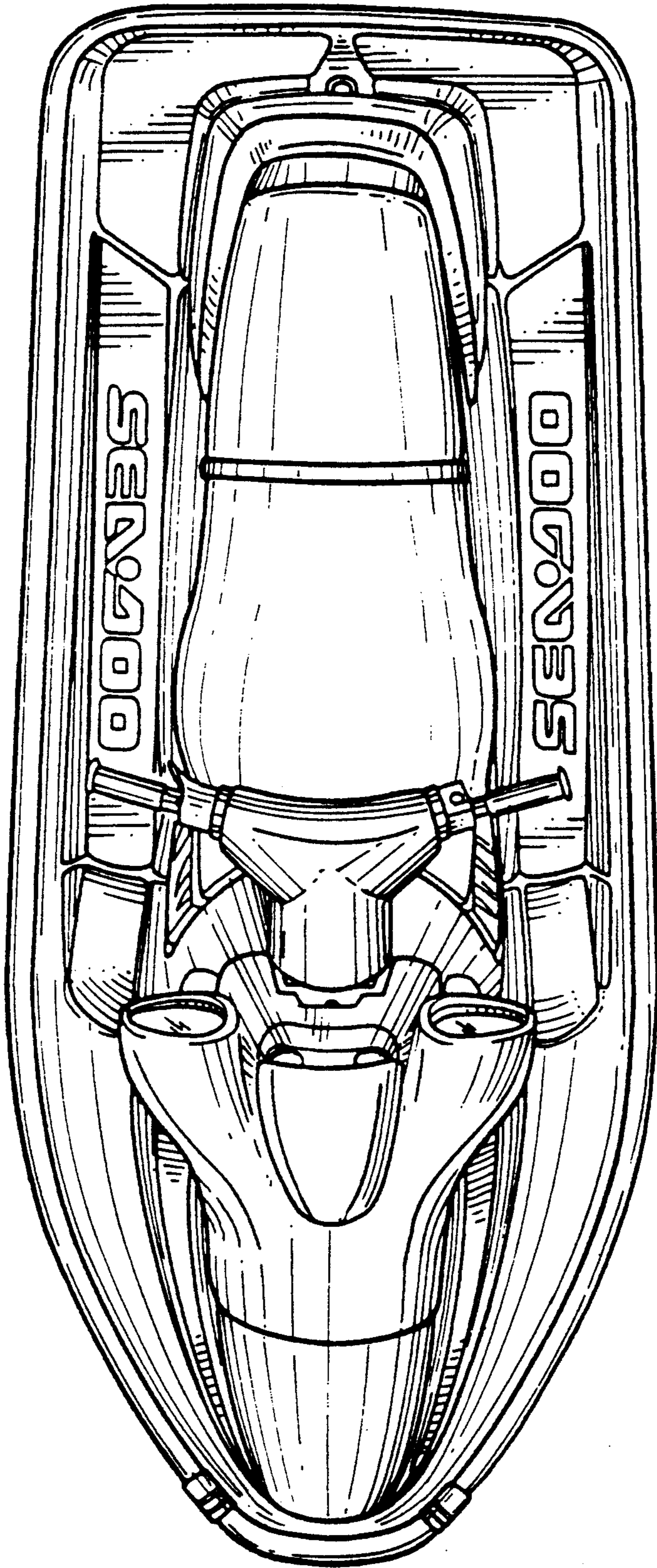

FIG. 5

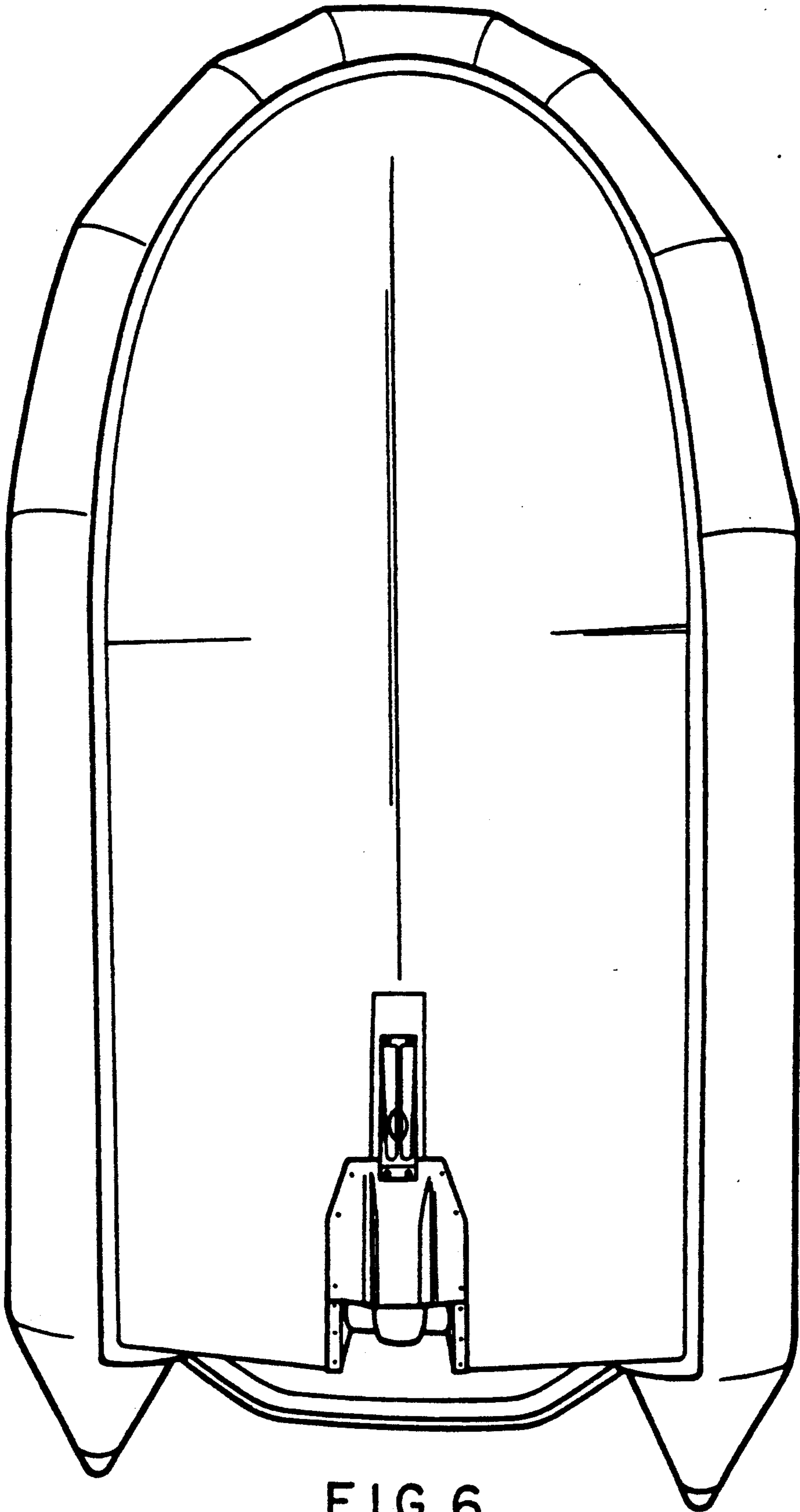

FIG. 6